



TRAKTORI- MALLI	SYLINTERI- LUKU	SYLINTERIN HALKAISUUS
Major	4	100
Super Major	4	100
Dexta (A)	3	88.90
Super Dexta (B)	3	91.49
2000	3	106.68
2310	3	106.68
2600	3	106.68
2610	3	106.68
2810	3	106.68
2910	3	106.68
3000	3	106.68
3230	3	111.76
3430	3	111.76
3600	3	106.68
3610	3	111.76
3900	3	106.68
3910	3	111.76
3930	3	111.76
4000	3	111.76
4100	3	106.68
4110	3	111.76
4130	3	111.76
4600	3	111.76
4610	3	111.76
4630	3	111.76
4830	4	111.76
5000 (→3/68)	4	106.68
5000 (4/68→)	4	111.76
5030	4	111.76
5110	4	111.76
5600 (→9/80)	4	106.68
5600 (10/80→)	4	111.76
5610	4	111.76
5610S	4	111.76
5640	4	111.76
5700	4	106.68
5900	4	111.76
6410	4	111.76
6600	4	111.76
6610	4	111.76

TRAKTORI- MALLI	SYLINTERI- LUKU	SYLINTERIN HALKAISUUS
6610s	4	111.76
6640	4	111.76
6700	4	111.76
6710	4	111.76
6810	4T	111.76
6810s	4T	111.76
7000	4T	111.76
7010	4T	111.76
7410	4T	111.76
7600	4T	111.76
7610	4T	111.76
7610s	4T	111.76
7700	4T	111.76
7710	4T	111.76
7740	4T	111.76
7810	6	111.76
7810s	6	111.76
7840	6	111.76
7910	6	111.76
8000	6	111.76
8010	6	111.76
8160	6	111.76
8200	6	111.76
8210	6	111.76
8240	6	111.76
8260	6	111.76
8340	6	111.76
8340 Turbo	6T	111.76
8360	6	111.76
8530	6	111.76
8560	6	111.76
8600	6	111.76
8630	6T	111.76
8670	6T	111.76
8700	6	111.76
8730	6T	111.76
8770	6T	111.76
8830	6T1	111.76
8870	6T1	111.76
8970	6T1	111.76

TRAKTORI- MALLI	SYLINTERI- LUKU	SYLINTERIN HALKAISUUS
9000	6T	111.76
9200	6T	111.76
9600	6T	111.76
9700	6T	111.76
TL70	4	100
TL80, TL80A	4	104
TL90, TL90A	4T	104
TL100	4T	104
TM115	6	111.76
TM120 Intercooler	6T	111.76
TM125	6T	111.76
TM135	6T	111.76
TM140 Intercooler	6T	111.76
TM150	6T	111.76
TM155 Intercooler	6T	111.76
TM165	6T	111.76
TM175 Intercooler	6T	111.76
TM190 Intercooler	6T	111.76
TN65F	4	104
TN75F	4	104
TN90F	4T	104
TN55V/D/S	3	104
TN56V/D/S	3	104
TN75V/D/S	3T	104
TS80	4	111.76
TS90	4	111.76
TS100	4T	111.76
TS100A Intercooler	4T	111.76
TS110	4T	111.76
TS110A Intercooler	4T	111.76
TS115	6	111.76
TW5	6	111.76
TW10	6	111.76
TW15	6T	111.76
TW20	6T	111.76
TW25	6T	111.76
TW30	6T1	111.76
TW35	6T1	111.76

FORDSON DEXTA

F0669	Mäntä-sylinteriputkisarja	3 kpl
F0275	Ylätiivistesarja	1 kpl
F0277	Alatiivistesarja	1 kpl
V382/3	KK-laakerisarja STD	1 kpl
V382/3A	KK-laakerisarja 010	1 kpl
V382/3B	KK-laakerisarja 020	1 kpl
V383	RK-laakerisarja STD	1 kpl
V383A	RK-laakerisarja 010	1 kpl
V383B	RK-laakerisarja 020	1 kpl
V383C	RK-laakerisarja 030	1 kpl

FORDSON SUPER DEXTA

V374X	Mäntä	3 kpl
V362RD	Männänrengassarja	3 kpl
V371L	Sylinteriputki	3 kpl
F0275	Ylätiivistesarja	1 kpl
F0277	Alatiivistesarja	1 kpl
V382/3	KK-laakerisarja STD	1 kpl
V382/3A	KK-laakerisarja 010	1 kpl
V382/3B	KK-laakerisarja 020	1 kpl
V383	RK-laakerisarja STD	1 kpl
V383A	RK-laakerisarja 010	1 kpl
V383B	RK-laakerisarja 020	1 kpl
V383C	RK-laakerisarja 030	1 kpl

FORDSON MAJOR

- valmiit putket

F0666	Mäntä-sylinteriputkisarja	4 kpl
F0012	Tiivistesarja täydellinen	1 kpl
F0454	KK-laakerisarja STD	1 kpl
F0454A	KK-laakerisarja 010	1 kpl
F0454B	KK-laakerisarja 020	1 kpl
F0454C	KK-laakerisarja 030	1 kpl
F0455	RK-laakerisarja STD	1 kpl
F0455A	RK-laakerisarja 010	1 kpl
F0455B	RK-laakerisarja 020	1 kpl
F0455C	RK-laakerisarja 030	1 kpl

FORDSON POWER MAJOR

- valmiit putket

F0667	Mäntä-sylinteriputkisarja	4 kpl
F0013	Tiivistesarja täydellinen	1 kpl
F0454	KK-laakerisarja STD	1 kpl
F0454A	KK-laakerisarja 010	1 kpl
F0454B	KK-laakerisarja 020	1 kpl
F0454C	KK-laakerisarja 030	1 kpl
F0455	RK-laakerisarja STD	1 kpl
F0455A	RK-laakerisarja 010	1 kpl
F0455B	RK-laakerisarja 020	1 kpl
F0455C	RK-laakerisarja 030	1 kpl

FORDSON SUPER MAJOR

- valmiit putket

F0668	Mäntä-sylinteriputkisarja	4 kpl
F0013	Tiivistesarja täydellinen	1 kpl
F0454	KK-laakerisarja STD	1 kpl
F0454A	KK-laakerisarja 010	1 kpl
F0454B	KK-laakerisarja 020	1 kpl
F0454C	KK-laakerisarja 030	1 kpl
F0455	RK-laakerisarja STD	1 kpl
F0455A	RK-laakerisarja 010	1 kpl
F0455B	RK-laakerisarja 020	1 kpl
F0455C	RK-laakerisarja 030	1 kpl

6600 (10/80-), 6610

- valmiit putket

V3712X	Mäntä	4 kpl
V3712R	Männänrengassarja	4 kpl
V3712LS	Sylinteriputki	4 kpl
V11043	Kansitiiviste	1 kpl
V808	Ylätiivistesarja	1 kpl
V809	Alatiivistesarja	1 kpl
V3751	KK-laakerisarja STD	1 kpl
V3751A	KK-laakerisarja 010	1 kpl
V3751B	KK-laakerisarja 020	1 kpl
V3761	RK-laakerisarja STD	1 kpl
V3761A	RK-laakerisarja 010	1 kpl
V3761B	RK-laakerisarja 020	1 kpl

3000

V3711X	Mäntä	3 kpl
V3711R	Männänrengassarja	3 kpl
V3711LS	Sylinteriputki	3 kpl
V11040	Kansitiiviste	1 kpl
V807	Ylätiivistesarja	1 kpl
V806	Alatiivistesarja	1 kpl
V3750	KK-laakerisarja STD	1 kpl
V3750A	KK-laakerisarja 010	1 kpl
V3750B	KK-laakerisarja 020	1 kpl
V3760	RK-laakerisarja STD	1 kpl
V3760A	RK-laakerisarja 010	1 kpl

3600

- valmiit putket

V3711X	Mäntä	3 kpl
V3711R	Männänrengassarja	3 kpl
V3711LS	Sylinteriputki	3 kpl
F0251	Kansitiiviste	1 kpl
V807	Ylätiivistesarja	1 kpl
V806	Alatiivistesarja	1 kpl
V3750	KK-laakerisarja STD	1 kpl
V3750A	KK-laakerisarja 010	1 kpl
V3750B	KK-laakerisarja 020	1 kpl
V3760	RK-laakerisarja STD	1 kpl
V3760A	RK-laakerisarja 010	1 kpl

5000 (65-3/68), 5600, County 654

- 5000 (65-3/68) 3,8 litraa

V3711X	Mäntä	4 kpl
V3711R	Männänrengassarja	4 kpl
V3711LS	Sylinteriputki	4 kpl
V11043	Kansitiiviste	1 kpl
V808	Ylätiivistesarja	1 kpl
V809	Alatiivistesarja	1 kpl
V3751	KK-laakerisarja STD	1 kpl
V3751A	KK-laakerisarja 010	1 kpl
V3751B	KK-laakerisarja 020	1 kpl
V3761	RK-laakerisarja STD	1 kpl
V3761A	RK-laakerisarja 010	1 kpl
V3761B	RK-laakerisarja 020	1 kpl

655, 5000 (4/68-), County 754

- 5000 (4/68-) 4,2 litraa

V3713X	Mäntä	4 kpl
V3712R	Männänrengassarja	4 kpl
V3712LS	Sylinteriputki	4 kpl
V11043	Kansitiiviste	1 kpl
V808	Ylätiivistesarja	1 kpl
V809	Alatiivistesarja	1 kpl
V3751	KK-laakerisarja STD	1 kpl
V3751A	KK-laakerisarja 010	1 kpl
V3751B	KK-laakerisarja 020	1 kpl
V3761	RK-laakerisarja STD	1 kpl
V3761A	RK-laakerisarja 010	1 kpl
V3761B	RK-laakerisarja 020	1 kpl

7000, 7600, 7700, County 944, 964, 974

- valmiit putket

V3714X	Mäntä	4 kpl
V3714R	Männänrengassarja	4 kpl
V3712LS	Sylinteriputki	4 kpl
V11043	Kansitiiviste	1 kpl
V808	Ylätiivistesarja	1 kpl
V809	Alatiivistesarja	1 kpl
V3752	KK-laakerisarja STD	1 kpl
V3752A	KK-laakerisarja 010	1 kpl
V3761	RK-laakerisarja STD	1 kpl
V3761A	RK-laakerisarja 010	1 kpl
V3761B	RK-laakerisarja 020	1 kpl

6600, 6700, 5610

V3713X	Mäntä	4 kpl
V3712R	Männänrengassarja	4 kpl
V3712LS	Sylinteriputki	4 kpl
V11043	Kansitiiviste	1 kpl
V808	Ylätiivistesarja	1 kpl
V809	Alatiivistesarja	1 kpl
V3751	KK-laakerisarja STD	1 kpl
V3751A	KK-laakerisarja 010	1 kpl
V3751B	KK-laakerisarja 020	1 kpl
V3761	RK-laakerisarja STD	1 kpl
V3761A	RK-laakerisarja 010	1 kpl
V3761B	RK-laakerisarja 020	1 kpl

26.10.2007



K1000



MF0343



MF0349



F0281



VPB7301



V3847N



F0112



V378L



F0274



VPB4520

OSA	DEXTA	SUPER DEXTA	MAJOR 52-3/57	POWER MAJOR 4/57-2/61	SUPER MAJOR 2/61-
1. Täydellinen sylinteriputkisarja 1-syl.	F0669		F0666 (g)	F0667 (g)	F0668 (g)
2. Putki	V371L 81803819	V371L (i) 81803819 V374L (h)	V377L 81710301	V377L (b) 81710301	V378L (c) 81710303
3. Mäntä ilman renkaita	V370X 81803864	V374X 81803866	F0273 (d) 81710337	F0274 (e) 81710338	F0274 (e) 81710338
4. Männänrenkassarja yhteen mäntään	V370R 81717647	V362RD 81803918 V374R (h) 81803866	VPB4520 81814624	VPB4520 81814624	VPB4520 81814624
5. Kiertokanki	MF0343 81803971	MF0343 81803971			
6. Mutteri	V3847N 83956276	V3847N 83956276	V3847N 83956276	V3847N 83956276	V3847N 83956276
7. Pultti	MF0349 81803991	MF0349 81803991			
8. Pusla KK-ylä	V1962 81803978	V1962 81803978		F0112 81710453	F0112 81710453
9. Syl.putken O-rengas ylempi					F0283 81716220
alempi			F0281	F0281	F0282 81716221
Sylinteriputken sovitelevy					
0.003" 0.0762 mm			VPB7300	VPB7300	
0.004" 0.1016 mm			VPB7301	VPB7301	
0.005" 0.127 mm			VPB7302	VPB7302	

b - huomioi putken alapään ulkohalkaisija 108,61 mm

c - huomioi putken alapään ulkohalkaisija 111,76 mm

d - männäntappi 32 mm

e - männäntappi 35 mm

g - sisältää putken o-renkaat

h - kromiputkelle valurautarenkaat

i - voidaan sovittaa **F0272** tai **F0272A** (ulkopuolinen ylisuuri +0,25 mm) olakkeelliset putket

k - koko moottori

26.10.2007

Huom.

Kaikki Ford-männät ovat teräsvahvisteisia



V3712LS



V3713X



V3712R

TRAKTORI-MALLI	1. PUTKI PUOLIVALMIS	2. MÄNTÄ STD	3. MR-SARJA STD
2000	V3711LS 81815327		V3711R 83917464
3000	V3711LS 81815327	V3711X 83910850	V3711R 83917464
4000, 550, 555	V3712LS (a) 83912946	V3712X (b) 81877563	V3712R 83917468
5000 (1965-3/1968) 3,8 l	V3711LS 81815327	V3711X 83910850	V3711R 83917464
5000 (4/1968→) 4,2 l	V3712LS (a) 83912946	V3713X 83937063	V3712R 83917468
7000	V3712LS (a) 83912946	V3714X 83912026	V3714R 83905823
8000, 8200, 1968-9/1972	V3712LS (a) 83912946	V3712X (b) 81877563	V3712R 83917468
COUNTY 764, 774, →1980	V3712LS (a) 83912946	V3713X 83937063	V3712R 83917468
COUNTY 764, 774, 1980-1982	V3712LS (a) 83912946	V3712X (b) 81877563	V3712R 83917468
COUNTY 964, 974, →1980	V3712LS (a) 83912946	V3714X 83912026	V3714R 83905823
COUNTY 1164, 1971-9/1972	V3712LS (a) 83912946	V3712X (b) 81877563	V3712R 83917468
COUNTY 1164, 10/1972-1975	V3712LS (a) 83912946	VPB2570 83905772	V3714R 83905823
3600	V3711LS 81815327	V3711X 83910850	V3711R 83917464
4100	V3711LS 81815327		V3711R 83917464
4600, 4630	V3712LS (a) 83912946	V3712X (b) 81877563	V3712R 83917468
5600	V3711LS 81815327	V3711X 83910850	V3711R 83917464
6600, 6700, 75-80	V3712LS (a) 83912946	V3713X 83937063	V3712R 83917468
7600, 7700	V3712LS (a) 83912946	V3714X 83912026	V3714R 83905823
7810, 7910, 8210 1982-1986, 8700, 8000, TW 10	V3712LS (a) 83912946	VPB2570 83905772	V3714R 83905823
TW 5 1982-3/1986, 8600 10/1972→	V3712LS (a) 83912946	VPB2570 83905772	V3714R 83905823
3910	V3712LS (a) 83912946		V3712R 83917468
4110	V3712LS (a) 83912946		V3712R 83917468
4610, 6600 10/1980→	V3712LS (a) 83912946	V3712X (b) 81877563	V3712R 83917468

Katso huomautukset seuraavalta sivulta.

B1.04

26.10.2007

Huom.

Kaikki Ford-männät ovat teräsvahvisteisia



V3712LS



V3713X



V3712R

TRAKTORI-MALLI	1. PUTKI PUOLIVALMIS	2. MÄNTÄ STD	3. MR-SARJA STD
3930, 4130, 4630, 4610	V3712LS (a) 83912946	V3712X (b) 81877563	V3712R 83917468
5610	V3712LS (a) 83912946	V3713X	V3712R 83917468
6410, 6610, 6710 1981-7/1987	V3712LS (a) 83912946	V3712X (b) 81877563	V3712R 83917468
7610, 7710, TW 15, 20, 25, 30, 35 8630, 8730, 8830	V3712LS (a) 83912946	VPB2580 83913727	V3714R 83905823
7810, 7910, 8210, TW5 4/1986→	V3712LS (a) 83912946	V3712X (b) 81877563	V3712R 83917468
8530	V3712LS (a) 83912946	V3712X (b) 81877563	V3712R 83917468
5640, 7840	F0570 83998292		F0574 87801095
6640, 8240	F0570 83998292	F0572 87801071	F0574 87801095
7740, 8340	F0570 83998292	F0573 87801072	F0575 87801086

a - saatavana erikoisvahva **V3712LHD** lohkon korjausputki

b - ei Headland

26.09.2011

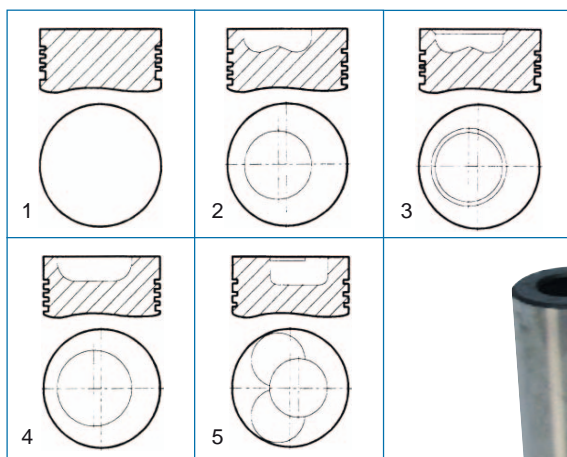



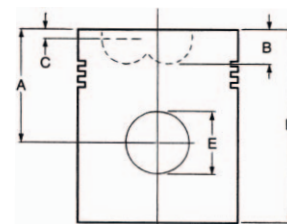









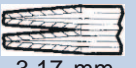
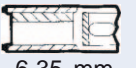
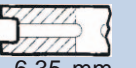
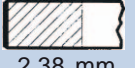
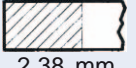
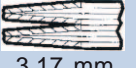

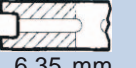
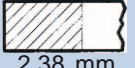
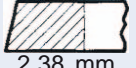

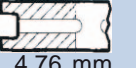
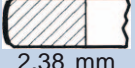
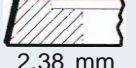
V3713X

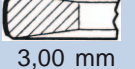
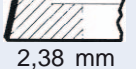

- A männän keskiökorkeus mm
- B palotilan syvyys mm
- C venttiilitilan syvyys mm
- D kokonaiskorkeus mm
- E männäntapin halkaisija mm

TUOTE- NUMERO	MALLI	Ø mm	MÄNNÄN- RENKAITA KPL	TERÄS- VAHVIS- TEINEN	A mm	B mm	C mm	D mm	E mm
V370X	1	88,92	5	ei	57,30			108,10	31,75
V374X	1	91,49	5	ei	56,92			107,70	31,75
F0274	5	100,00	5	ei	70,99	24,61	1,65	118,10	34,92
	4	106,68	4	kyllä	75,20	13,20		134,20	38,10
	4	106,68	4	kyllä	75,20	13,20		134,20	38,10
	4	106,68	4	kyllä	70,18	17,28		129,18	38,10
	4	106,68	4	ei	67,64	18,11		126,47	38,10
V3711X	4	106,68	4	ei	70,18	17,28		129,18	38,10
	2	111,76	4	kyllä	68,12	22,00		127,12	38,10
V3712X	4	111,76	4	kyllä	68,12	19,82		127,12	38,10
V3713X	4	111,76	4	kyllä	70,55	18,50		129,55	38,10
V3714X	4	111,76	4	kyllä	70,38	22,17		129,26	41,27
VPB2570	4	111,76	4	kyllä	68,12	19,80		126,50	38,10
VPB2580	4	111,76	4	kyllä	67,80	19,00		126,80	41,27
		111,76	4	kyllä		19,00			
	3	111,76	4	kyllä	68,12	19,00		127,00	38,10
	4	111,76	4	kyllä	67,87	18,92		126,75	41,27
	3	111,76	4	kyllä	67,90	18,00		126,70	41,27

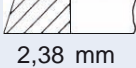
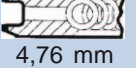

TUOTE- NUMERO	ø mm					
V370R	88,92	 2,38 mm	 2,38 mm	 3,17 mm	 6,35 mm	 6,35 mm
V362RD	91,49	 2,38 mm	 2,38 mm	 3,17 mm	 6,35 mm	 6,35 mm
VPB4520	100,00	 2,38 mm	 2,38 mm	 2,38 mm	 4,76 mm	 4,76 mm
V3711R	106,68	 2,38 mm	 2,38 mm	 2,38 mm	 4,76 mm	
V3712R	111,76	 2,38 mm	 2,38 mm	 2,38 mm	 4,76 mm	
V3714R	111,76	 3,00 mm	 2,38 mm	 2,38 mm	 4,76 mm	
	111,76	 2,38 mm	 2,38 mm	 4,76 mm		

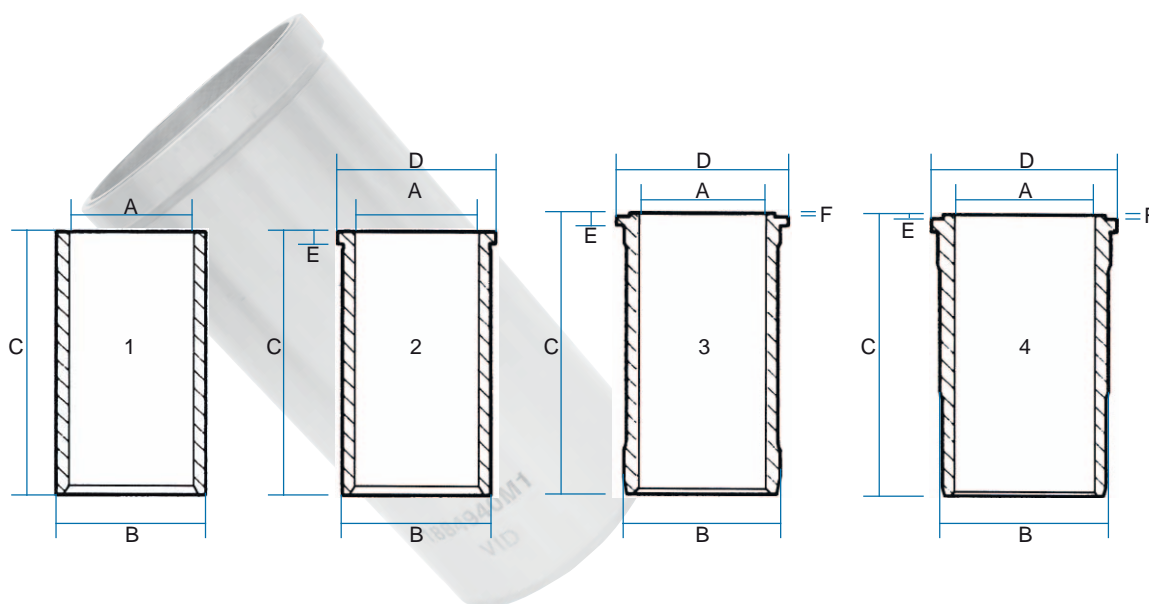

VALMIIT PUTKET

A nimellinen halkaisija mm
B ulkohalkaisija mm
C kokonaispituus mm

D laipan halkaisija mm
E laipan vahvuus mm
F laipan ylitys mm

TUOTE- NUMERO	MALLI	A mm	B mm	C mm	D mm	E mm	F mm
V374L	2	91,49	93,68	215,90	96,77	1,14	
V377L	4	100,00	108,61	223,01	117,40	11,18	0,64
V378L	3	100,00	111,76	222,89	119,63	11,18	0,66

PUOLIVALMIIT PUTKET

TUOTE- NUMERO	MALLI	A mm	B mm	C mm	D mm	E mm	F mm
V371L	1	88,92	93,74	216,15			
V3711LS	1	106,68	110,78	209,55			
V3712LS	2	111,76	114,43	208,53	120,35	2,57	
	1	111,76	116,97	208,53			
	2	111,76	116,97	208,53	120,35	2,57	
	1	111,76	114,40	205,60			

08.05.2009



OSA	DEXTA	SUPER DEXTA	MAJOR	POWER MAJOR	SUPER MAJOR
1. Kampiakseli laakereineen	V390K 81815395	V390K 81815395			
2. Kk-laakerisarja	STD	V382/3 81717671	V382/3 81717671	F0454 81854542	F0454 81854542
	010"	V382/3A 81803985	V382/3A 81803985	F0454A 81854543	F0454A 81854543
	020"	V382/3B 81803986	V382/3B 81803986	F0454B 81854544	F0454B 81854544
	030"			F0454C 81854545	F0454C 81854545
3. Rk-laakerisarja	STD	V383	V383	F0455 81823481	F0455 81823481
	010"	V383A	V383A	F0455A 81823483	F0455A 81823483
	020"	V383B	V383B	F0455B 81823484	F0455B 81823484
	030"	V383C	V383C	F0455C 81823487	F0455C 81823487
4. Etustefa	F0127 81717731	F0127 81717731	F0025 81710683	F0025 81710683	F0025 81710683
5. Takatiiviste	V399 81717827	V399 81717827	F0108 81854827	F0108 81854827	F0108 81854827
6. Päätislaakeri- sarja	STD	MF0700	MF0700	F0785 E159Z9	F0785 E159Z9
	+0.007"	MF0700A	MF0700A		
7. Kampiakselin eturatas	MF0130 81804043	MF0130 81804043			

TASAPAINOKONEISTO HAMMASPYÖRÄT

- moottorityytit 8/1986 saakka
BS0442, BSD444, BSD444T
- hampaan leveys 12,6 mm
- 39 hammasta

F0565

83924289
D9NN6B303AB
- 5000, 5100, 5110, 5190, 5200, 5340, 550, 555, 5600,
650, 655, 755



TASAPAINOKONEISTO HAMMASPYÖRÄT

- moottorityytit 9/1986 eteenpäin
BSD442, BSD444, BSD444T
- hampaan leveys 15,4 mm
- 38 hammasta
- 4830, 5030, 5110, 555, 5600, 5610, 5700, 575,
5900, 6410, 650, 655, 6600, 6610, 6700, 6710,
675, 6810, 7600, 7610, 7700, 7710

F0568

81873999
83955922, 83903994
F1NN6B302AA, E5NN6B302AA

F0569

81874001, 83937055
83955920, 81839600
F1NN6B303AA, E5NN6B303AA

26.09.2011

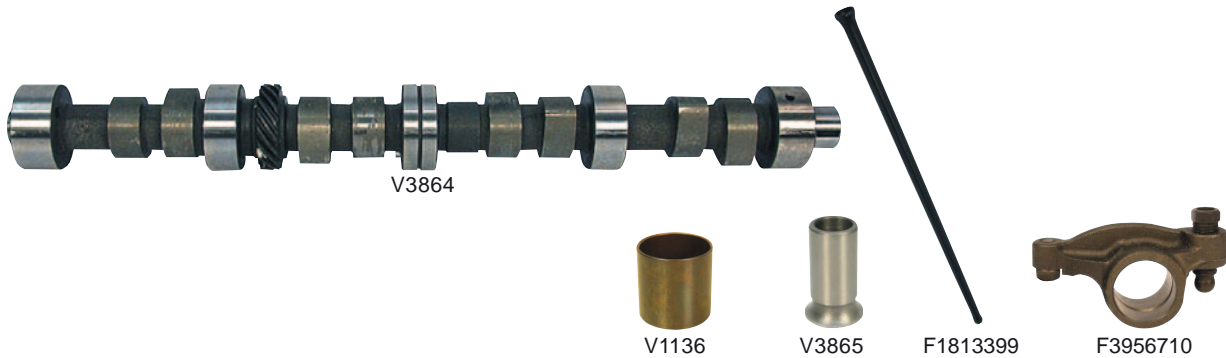

TRAKTORI-MALLI	2000, 2310, 2600, 2610, 2810, 2910, 3000, 3600, 3610, 3910, 4000, 4100, 4110, 4600, 4610	5000 5110 5600 5610 6410 6600 6610 6700 6710 6810	7000 7600 7700 7610 7710	7810 7910 8000 8200 8210 8530 8600 8700 TW 5 TW 10	3230 3430 3930 4130 4630	5640 6640 TS80 TS90	7740 TS100 TS110	
1. Kampiakseli			F3918890 (d) 83918890	F3918890 (d) 83918890				
2. Runkolaakeri-sarja	STD	V3760	V3761	V3761	2 x V3760	V3760 (f)	F0578	F0578
	010"	V3760A	V3761A	V3761A	2 x V3760A	V3760A		
	020"		V3761B	V3761B				
	030"		V3761C	V3761C				
3. Kiertokangens laakerisarja	STD	V3750	V3751	V3752 (e)	2 x V3750	V3750 (a)	F0576	F0577
	010"	V3750A	V3751A	V3752A	2 x V3750A	V3750A (a)		
	020"	V3750B	V3751B		2 x V3750B	V3750B (a)		
4. Pusla	V1136 81803972	V1136 81803972	F0244 81819460	V1136 81803972				
5. Pultti	V3847B 83990584	V3847B 83990584	V3847B 83990584	V3847B 83990584	V3847B (a) 83990584			
6. Mutteri	V3847N 83956276	V3847N 83956276	V3847N 83956276	V3847N 83956276	V3847N (a) 83956276			
7. Nokka-askeli	V3863 87800323	V3864 87800353	V3864 87800353		V3863 87800323			
8. Nostajan malja	V3865 83957729	V3865 83957729	V3865 83957729	V3865 83957729	V3865 83957729			
9. Nokka-askelin laakeri	V1137 87800499	V1137 87800499	V1137 87800499	V1137 87800499	V1137 87800499			
10. Nostajan tanko	F1813399 81813399	F1813399 81813399	F1813399 81813399	F1813399 81813399	F1813399 81813399			
11. Keinuvipu	F3956710 83956710	F3956710 83956710	F3956710 83956710	F3956710 83956710	F3956710 83956710			

a - 3/90 - 8/90

d - kampiakseli 4,4 l koneisiin 81-10/91, tasapainopyörästön käyttörattaan hammasluku 76, myös hyvä valikoima takuuvaihtokampiakseleita

e - 7610, 7710→31/03 -91

f - →8/92

08.05.2009

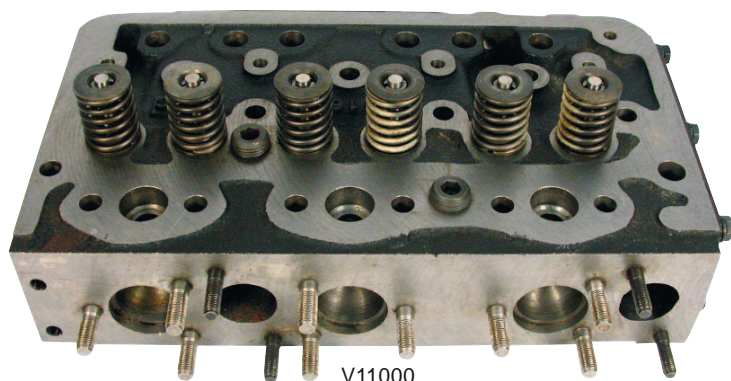

TRAKTORI-MALLI	SYLINTERINKANSI	IMU-VENTTIILI	PAKO-VENTTIILI	OHJURI IMU/PAKO	JOUSI	LUKKOPALAT
DEXTA	V11000	V10009 81717767	V10008 81717764	V596 81804289	V10019 81804295	VPA2302 81876796
SUPER DEXTA	V11000	V10009 81717767	V10008 81717764	V596 81804289	V10019 81804295	VPA2302 81876796
MAJOR		F0115 81710772	F0116 81702234	F0118		
POWER MAJOR		F0115 81710772	F0116 81702234	F0118		
SUPER MAJOR		F0115 81710772	F0116 81702234	F0118	F0270	

Huom.

Tiedustele myös takuuvaihtokansia



TRAKTORI-MALLI	SYLINTERIPUTKI	IMU-VENTTIILI	PAKO-VENTTIILI	VENTTIILIOHJURI	KKHELA
FORDSON E27N Perkins P6 moottorilla 3245104 1945 -	V370L 0530002	V10009 0910001	V10008 0910002	V596 81804289	V1962 0050119

ETUKAMMION KANSI Dexta

F1800075
37416511



OHJAINHOLKKI KANTEEN

F3960218
83960218

- 10, 100, 1000, 30 ja 40-sarjat



08.05.2009

Huom.

Venttiilikorjaussarjat sivulla B1.2.
Tiedustele myös
takuuvaihtosyinterikansia.

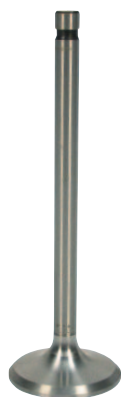

1. V10041



2. V10040



3. V10050



4. F0238



5. F0239



6. VPA2302

OSA		2000, 3000, 3600, 3910, 4000, 4100, 4110, 4600, 4610, 5000, 5600	5610, 6600, 6610, 6700, 6710, 6810, 7810, 7910, 8210	7000, 7600, 7610, 7700, 7710	8000, 8200, 8600, COUNTY 654, 754, 764, 774, 1164, TW 5, TW 10	TW 15, 20, 25, 30, 35, 8630, 8730 8830	3930, 4130, 4630, 8530
1. Imuventtiili	STD	V10041 81823823	V10041 81823823	F0237 87800386	V10041 81823823	F0237 87800386	V10041 81823823
	003"	V10041A 81823824	V10041A 81823824	F0237A 81865612	V10041A 81823824	F0237A 81865612	V10041A 81823824
	015"	V10041B 81823825	V10041B 81823825		V10041B 81823825		V10041B 81823825
2. Pakovennttiili	STD	V10040 81818709	F0236 87800340	F0236 87800340	V10040 81818709	F0236 87800340	V10040 81818709
	003"	V10040A 87800339	F0236A 83912599	F0236A 83912599	V10040A 87800339	F0236A 83912599	V10040A 87800339
	015"	V10040B 81818708			V10040B 81818708		V10040B 81818708
3. Jousi		V10050 83911693	V10050 83911693	V10050 83911693	V10050 83911693	V10050 83911693	V10050 83911693
4. Tiiviste imu		F0238 81804329	F0238 81804329	F0238 81804329	F0238 81804329	F0238 81804329	F0238 81804329
5. Tiiviste pako		F0239 81804330	F0239 81804330	F0239 81804330	F0239 81804330	F0239 81804330	F0239 81804330
6. Lukkopalat (2)		VPA2302 81876796	VPA2302 81876796	VPA2302 81876796	VPA2302 81876796	VPA2302 81876796	VPA2302 81876796

OSA		5640, 6640, 7840, 8240, 8340	7740, TS100, TS110 8340, 8360, 8560, 8670, 8770, 8870			
1. Imuventtiili		F0581 81865092	F0588 8285530			
2. Pakovennttiili		F0582 81865085	F0589 82850523			

21.09.2009

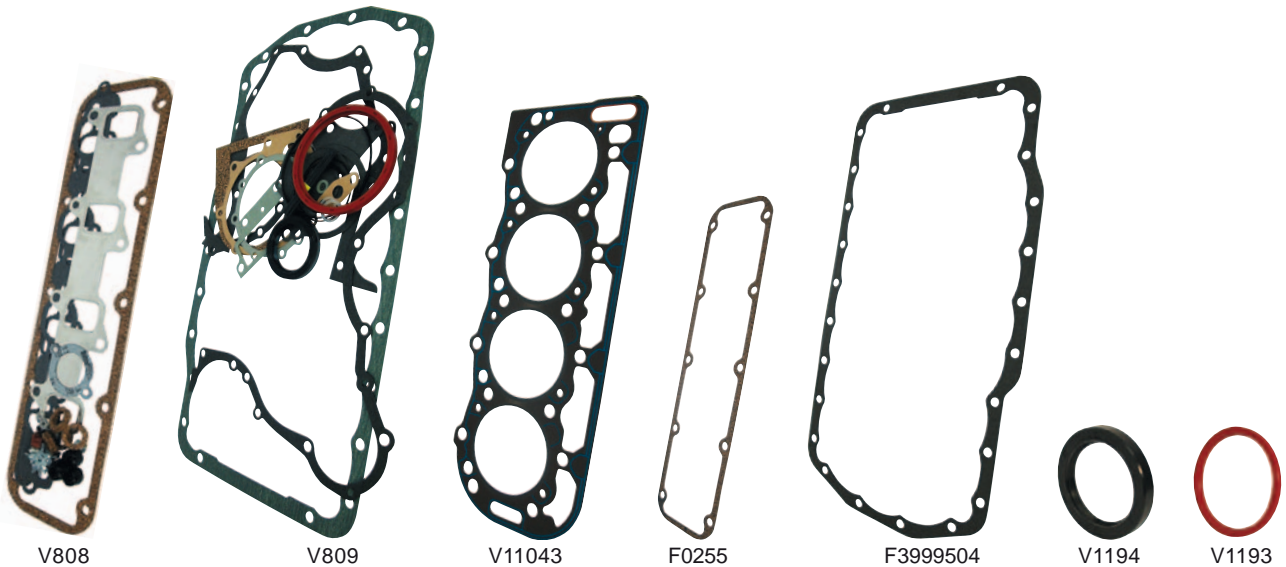

TRAKTORI-MALLI		YLÄPÄÄN TIIVISTE-SARJA	ALAPÄÄN TIIVISTE-SARJA	KANNEN TIIVISTE	VENTTIILI-KANNEN TIIVISTE	ÖLJY-POHJAN TIIVISTE	ETU-STEFA	TAKA-STEFA
2000, 3000		V807 (e) 82845204	V806 82845207	V11040 82845222	F0254 81817048	F3990594 83990594	V1194 87800696	V1193 83955247
3600, 4100		V807 (e) 82845204	V806 82845207	F0251 83961551	F0254 81817048	F3990594 83990594	V1194 87800696	V1193 83955247
4000 (g), 4600, 4110, 4610		V807 (e) 82845204	V806 82845207	F0252 (g) 83977022 F0651 (g) 81819541	F0254 81817048	F3990594 83990594	V1194 87800696	V1193 83955247
COUNTY 654, 5000 (6/1965-3/1968) 5600 (1975-9/1980)	3,8 L	V808 (e) 82845206	V809 81813951	V11042 81844763	F0255 81817049	F3999504 83999504	V1194 87800696	V1193 83955247
5000, 7000 (4/1968→)	4,2 L	V808 (e) 82845206	V809 81813951	V11043 (a) 87800517 F0253 (b) 81819542	F0255 81817049	F3999504 83999504	V1194 87800696	V1193 83955247
5600 (10/1980→) 6600, 6700, 7600, 7700 5610, 6610, 6710, 7610, 7710	4,2 L	V808 (e) 82845206	V809 81813951	V11043 (a) 87800517	F0255 81817049	F3999504 83999504	V1194 87800696	V1193 83955247
8600, 8700		VPA4109 (e) 81820788	VPC6104 82845239	F0587 (c) 87801752 VPA4328 (d) 82855144	VPA4522 83912957		V1194 87800696	V1193 83955247
9600, 9700			VPC6104 82845239	F0587 (c) 87801752 VPA4328 (d) 82855144	VPA4522 83912957		V1194 87800696	V1193 83955247
7810, 7910, 8210, 8401, TW5, TW10, TW15, TW20, TW25, TW30, TW35		VPA4110 (e) 83933430	VPC6103 82845239	VPA4328 82855144	VPA4522 83912957	F3999506 83999506	V1194 87800696	V1193 83955247
8530		VPA4110 (e) 83933430	VPC6103 82845239	VPA4328 82855144		F3999506 83999506	V1194 87800696	V1193 83955247
8630, 8730, 8830			VPC6103 82845239	VPA4328 82855144		F3999506 83999506	V1194 87800696	V1193 83955247
COUNTY 1164		VPA4109 (e) 81820788	VPC6104 82845239	F0587 87801752	VPA4522 83912957		V1194 87800696	V1193 83955247
COUNTY 1164 TW, 1184 TW		VPA4110 (e) 83933430	VPC6103 82845239	VPA4328 82855144	VPA4522 83912957	F3999506 83999506	V1194 87800696	V1193 83955247
COUNTY 754, 764, 774, 944, 964, 974 4830 (7/1990→)				V11043 (a) 87800517				
5640, 6640, 7740, TS80, 90, 100, 110		F0583 81878059	F0584 81878060	V11043 (a) 87800517			V1194 87800696	V1193 83955247
7840, 8240, 8340		F0585 81878060		F0587 87801752			V1194 87800696	V1193 83955247

a - vahvuus 1,43 mm
alkuperäispakkauksessa **F1873577**
b - **F0253** vahvuus 0,889 mm

c - 1968→7/1976
d - 8/1976→

e - ei sisällä kansitiivistettä
g - **F0252** 6/1969→
F0651 →5/1969

B1.13

Alkuperäisnumerot ovat ainoastaan vertailua varten, eivätkä tarkoita, että tuotteet ovat alkuperäisiä.
Taulukoissa esiintyvät kuvat ovat viitteellisiä.

05.02.2010

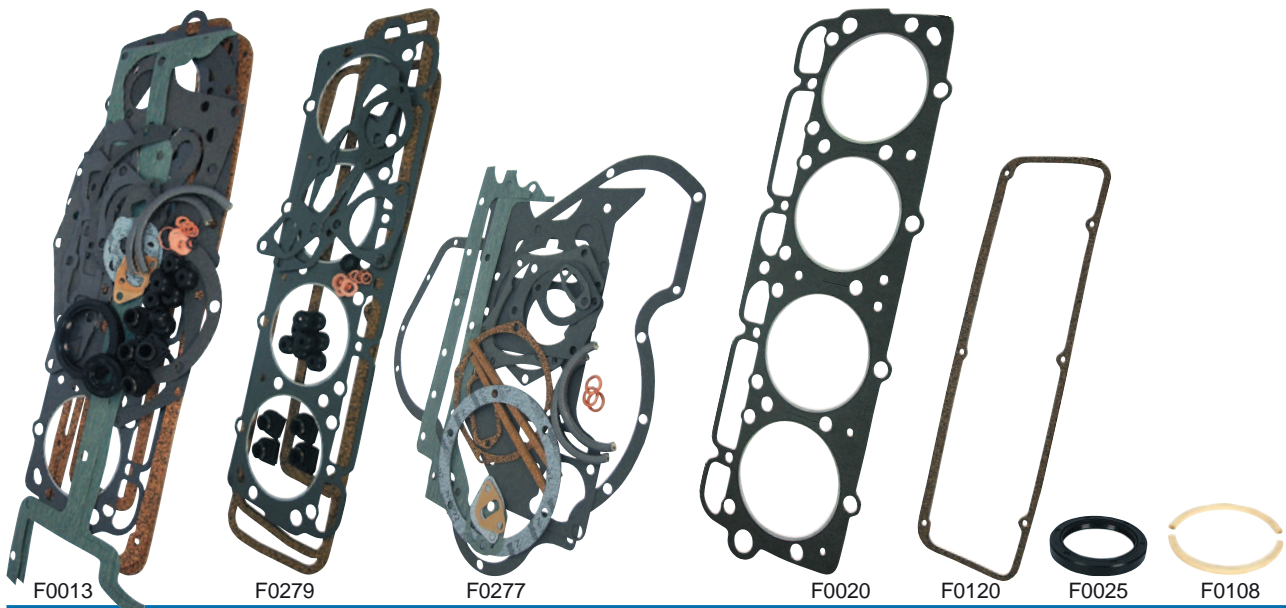

TRAKTORI-MALLI	TÄYDELLINEN TIIVISTE-SARJA	YLÄPÄÄN TIIVISTE-SARJA	ALAPÄÄN TIIVISTE-SARJA	KANNEN-TIIVISTE	VENTTIILI-KANNEN-TIIVISTE	KAMPI-AKSELIN ETU-STEFA	KAMPI-AKSELIN TAKA-TIIVISTE
DEXTA/SUPER DEXTA		F0275	F0277	MF0377 81803798	MF0263 81717801	F0127 81717731	V399 81717827
MAJOR	F0012 (c) 81743588			F0020 (b) 81710281	F1710842 81710842	F0025 81710683	F0108 81854827
POWER MAJOR	F0013 (c) 81743593	F0279 81743746		F0020 (b) 81710281	F1710842 81710842	F0025 81710683	F0108 81854827
SUPER MAJOR	F0013 (c) 81743593	F0279 81743746		F0020 (b) 81710281	F0120 (a) 81745491	F0025 81710683	F0108 81854827
COUNTY, TRADER 6-syl. 510 E	F1780567 81780567	F1780567A 81780567		F0478		F0025 81710683	F0108 81854827

Sylinteriputken O-renkaat sivulla B1.03

a - reiällinen malli 4/57-

b - lisäksi tarvitaan O-rengas F1710297

c - ei sisällä putken tiivisteitä, kampiakselin tiivisteet on mukana

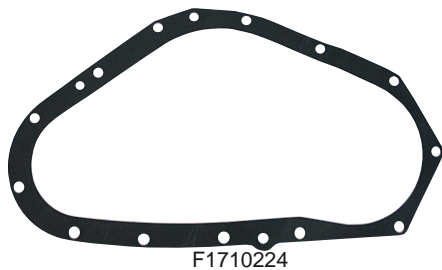

F1710224



F1780591



F1717825

TRAKTORI-MALLI	JAKOPÄÄN KOPAN TIIVISTE	ÖLJY-POHJAN TIIVISTE	ETUPÄÄN KORKKI-TIIVISTE
MAJOR	F1710224 82845242	F1780591 82845240	F1710903 81710903
2000, 2600, 3000, 3600, 3900, 3910, 4000, 4100, 4110, 4600, 4610, 5000, 5110, 5600, 5610, 5700, 6410, 6610, 6700, 6710, 6810, 7000, 7600, 7610, 7700, 7710, 7810, 7910, 8000, 8210, 8600, 8700, 9000, 9200, 9600	F1803753 81803753		

26.09.2011

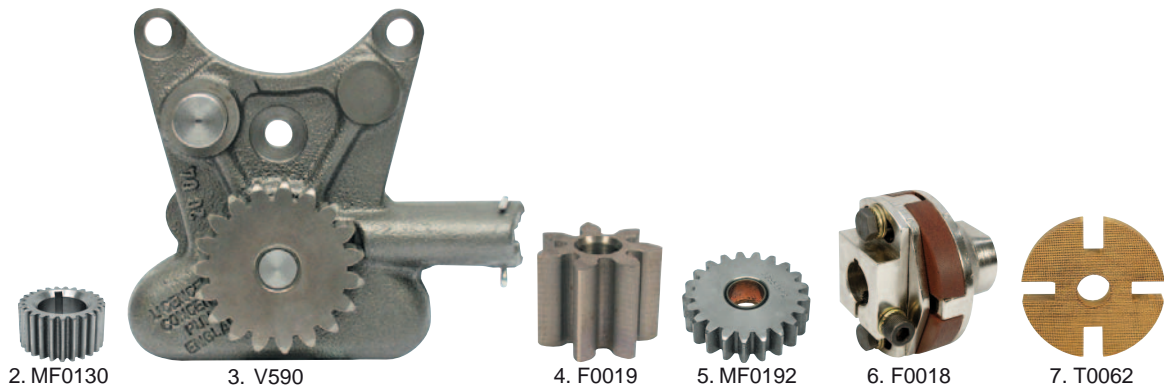

OSA	DEXTA	SUPER DEXTA	MAJOR	POWER MAJOR	SUPER MAJOR	COUNTY 6-syl. TRADER 508E, 510E
2. Kampiakselin ratas	MF0130 81804043	MF0130 81804043				
3. Öljypumppu	V590 (a) 81804347	V590 (a) 81804347	F0014 81745498	F0014 81745498	F0014 81745498	F0015 508E6600
4. Öljypumpun ratas			F0019 81710864	F0019 81710864	F0019 81710864	
5. Öljypumpun väliratas	MF0192 81804383	MF0192 81804383				
6. Syöttöpumpun kumikytkin			F0018	F0018	F0018	
7. Fiber-levy			T0062 81714537	T0062 81714537	T0062 81714537	

a - vaatii sovitusta

22.10.2010

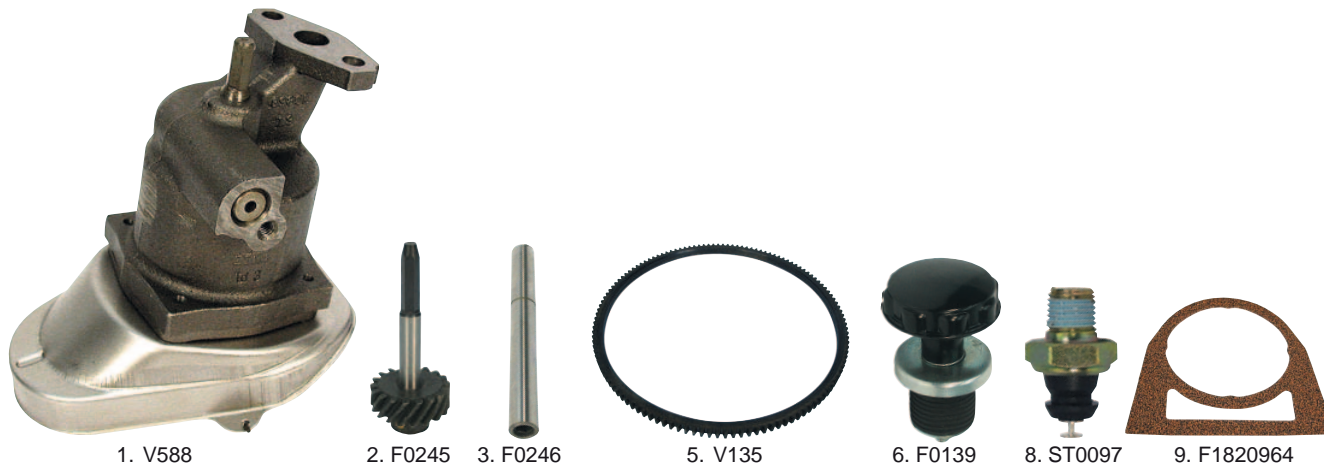

1. V588

2. F0245

3. F0246

5. V135

6. F0139

8. ST0097

9. F1820964

TRAKTORI-MALLI	2000 3000 4000 5000	7000	COUNTY 654, 754, 764, 774, 3600, 4100, 4600, 5600, 6600, 6700, 550, 555	7600 7700	3910 4110 4610 5610	6610, 6710, 7610, 7710, COUNTY 944 COUNTY 964 COUNTY 974	8000, 8200, 9600, 9700, 7910, 7810, 8210, TW5, TW10, TW15, TW25, TW35, 8530, 8630, 8830, 8730
1. Öljypumppu	V589 81873261	V588 83956421	V589 81873261	V588 83956421	V589 81873261	V588 83956421	
2. Käyttöratas	F0245 83984954	F0245 83984954	F0245 83984954	F0245 83984954	F0245 83984954	F0245 83984954	F0245 (a) 83984954
3. Käyttöakseli	F0246 81817395	F0246 81817395	F0246 81817395	F0246 81817395	F0246 81817395	F0246 81817395	F0246 (a) 81817395
4. Öljytikku			F0248 83982499	F0248 83982499	F0248 83982499	F0248 83982499	
5. Starttikehä	V135 83949153	V135 83949153	V135 83949153	V135 83949153	V135 83949153	V135 83949153	V135 83949153
6. Öljyntäyttökorkki	F0249 81823295	F0249 81823295	F0139 83907851	F0139 83907851	F0139 83907851	F0139 83907851	F0139 83907851
7. Öljypohjan tulppa	F0250 81822147	F0250 81822147	F0250 81822147	F0250 81822147	F0250 81822147	F0250 81822147	F0250 81822147
8. Moottorin öljykello	ST0097 81873524	ST0097 81873524	ST0097 81873524	ST0097 81873524	ST0097 (c) 81873524	ST0097 81873524	ST0097 81873524
9. Takakannen tiiviste	F1820964 81820964	F1820964 81820964	F1820964 81820964	F1820964 81820964	F1820964 81820964 F1864478 (b) 81864478	F1820964 81820964 F1864478 (b) 81864478	F1820964 81820964 F1864478 (b) 81864478

a - ainoastaan 7810 2/88 →

b - 4/87 →

c - ei sovi malliin 4610

26.09.2011

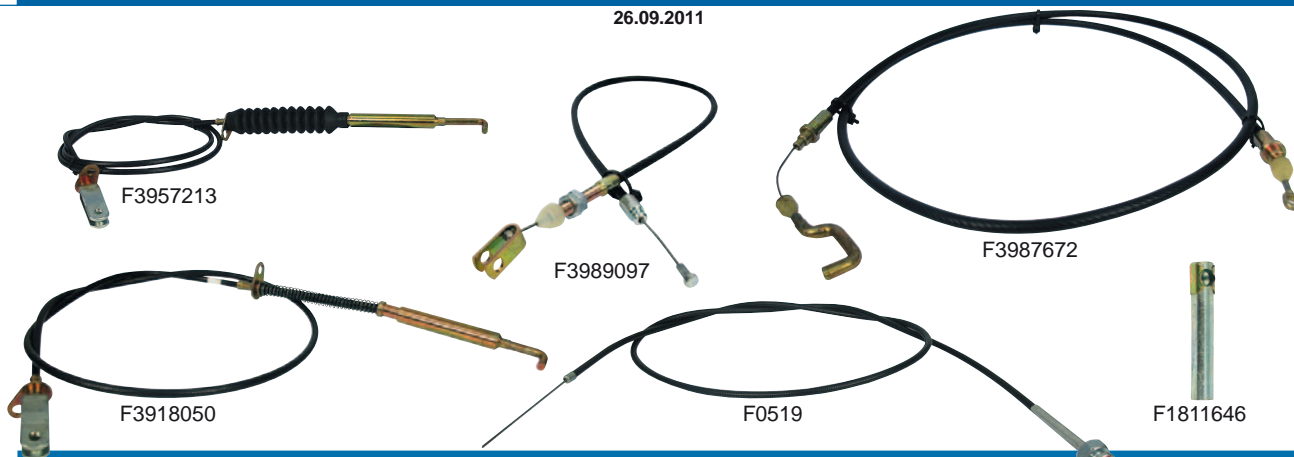

TRAKTORI-MALLI	KAASU-VAIJERI L-610 mm	KAASU-VAIJERI L-1470 mm	KAASU-VAIJERI L-1230 mm	KAASU-VIVUSTON NIVEL
3610, 4610, 3910, 4110, 4100, 4600	F3989097 83989097			F1811646 81811646
5610, 6610, 7610 10/1985→		F3957213 83957213		F1811646 81811646
6710, 7710 1981-9/1985		F3957213 83957213		F1811646 81811646
8210, 7810		F3957213 83957213		F1811646 81811646
5700, 6700, 7700 8/1976→			F3918050 83918050	F1811646 81811646
4830		F3987672 83987672		
2600, 3600, 5600, 6600 2310, 2610, 5110, →9/1985 5610, 6410, 6610, 6710, 6810, 7410, 7610, 7710,	F3989097 83989097			
7910, 8530, 8630, 8730, 8830, TW5, TW15, TW25, TW35		F3957213		

TRAKTORI-MALLI	SUUTINPUTKET 2-syl.
5600, 5610, 6600, 6610, 6700, 7700, 7600, 7610, rivipumpulla	Sarja kaikki neljä putkea F0567
3000 65→ jakaja-pumpulla	F1814572 81814572

TÄYDELLINEN POLTTOAINESUODATIN

- max. PA-virtaus 45 l/min.
- liitännät 1/2" x 20 UNF
- eri tulo- ja menoliitännävaihtoehtoja, katso kuva
- sopiva suodatin **MPCAV296, DFP556245**

MP5836B710

(kuvassa)

- 2000, 2310, 2600, 2610, 3000, 3600, 3610, 3910, 4000, 4100, 4110, 4600, 4610, 5000, 5600, 5610, 6600, 6610, 6700, 6710, 6810, 7000, 7410, 7600, 7610, 7700, 7710

F0560

81862754, 81866599, 2656818

- 1164, 2000, 2100, 2110, 2120, 230 A, 230 B, 231, 2310, 233, 250 C, 260 C, 2600, 2610, 2810, 2910, 3000, 3100, 3120, 3230, 333, 334, 335, 3400, 3430, 3500, 3550, 3600, 3610, 3900, 3910, 3930, 3930 N, 4000, 4100, 4110, 4130, 4200, 4400, 4410, 4600, 4610, 4630, 5000, 5030, 5100, 5110, 515, 5200, 530 A, 530 B, 531, 532, 535, 540, 540 A, 540 B, 550, 5500, 555, 555 A, 555 B, 5600, 5610, 5700, 5900, 6410, 650, 6500, 6600, 6610, 6700, 754, 764, 774, 8000, 8200, 8400, 8600, 8700, 9000, 944, 964, 9700, 974



F0566

883786M91
2656615
- lasipohja

TÄYDELLINEN VEDENEROTIN

F1711842

81711842

- sopii Major ja Super Major
- kierre 1/2" x 20 UNF
- lasikuppi **V48/2**, tiiviste **V750** (44 x 54 mm)
- liitin 7,5 mm letkulle **F1805866**, liitin 9,5 mm letkulle **MP717686**



POLTTOAINEPUTKI

F3917461

83917461

- 5000, 6600, rivipumpulla
- hanalta suodattimelle



B1.17

26.10.2007



7 hyvää syytä vaihtaa uudet suutinkärjet:

1. säästät polttoainetta
2. pidempi moottorin käyttöikä
3. puhtaammat päästöt
4. lisää tehoa
5. enemmän vääntöä
6. parempi käynnistyvyys
7. tasaisempi käynti



SD70085



T0402



T0400

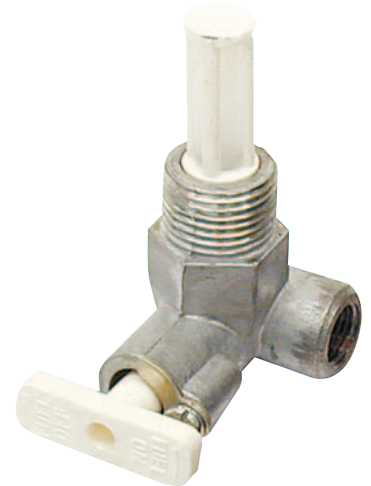

V8284

TRAKTORI-MALLI	SUUTTIMEN KÄRKI	VERTAILU-NUMERO	ALUS-LEVY	YLIVUOTO-PUTKEN ALUSLEVY	HANA
DEXTA	SD49133 81718678	BDL110S6133	T0401 81716268	T0400 81821105	
MAJOR POWER, SUPER	SD70028 81714498	BDLL150S6222	T0401 81716268	T0400 81821105	V8284 83935915
2000 3000	1964-1969 1965-1975	SD70075 81806140	BDLL150S6443	T0402 81806142	V8284 83935915
2000, 3000 5000 5000 jakajapumppu 5600	1964-1975 1965-1968 1972-1975 1979-1981	SD70109 81825598	BDLL150S6571	T0402 81806142	V8284 83935915
2000, 3000, 5000	4/1968→	SD70068 81834304	BDLL140S6422	T0402 81806142	V8284 83935915
3000, 4000 5000 rivipumppu 5500, 8000, 8600	1964-1975 4/1968-1975	SD70085 81813344	BDLL150S6476	T0402 81806142	V8284 83935915
3600, 5600 4100	1975-1980	SD70149 83900058	BDLL150S6665	T0402 81806142	V8284 83935915
3610, 5610 3600	10/1980→ 1980-1981	SD70181 83919131	BDLL150S6780	T0402 81806142	V8284 83935915
4600 6600, 6700 8600, 9700 8700	1975-1979 1975-1980 1975-1978 1976-1978	SD70150 83900061	BDLL150S6666	T0402 81806142	V8284 83935915
5900 4610, 6600, 6700 4600	1990→ 1979→ 1979-1981	SD70180 83917472	BDLL150S6774	T0402 81806142	V8284 83935915
3610 6610, 6710 8600 TW5, TW10, TW15	1983-1985 1980→ 1980-1981	SD70184 83919132	BDLL150S6790	T0402 81806142	V8284 83935915
7600, 7700	1975-1981	SD70151 83900064	BDLL150S6667	T0402 81806142	V8284 83935915
7610, 7710 TW25, TW35	1981→	SD70182 83919155	BDLL150S6781	T0402 81806142	V8284 83935915
7000 9000, 9600 9700 TW20, TW30	1965-1975 1969-1981 1977-1980 1978-1982	SD70101 81821327	BDLL150S6552	T0402 81806142	V8284 83935915
4130, 4630	1/1991→			T0402 81806142	V8284 83935915

22.10.2010



SIIRTOPUMPPU

F6038718

5020244

- 2700 sarja 254, 380
- 2715 E moot. 6-syl. 135HP
- D-K moot. diesel
- 2700E teollisuusmoottorit esim. New Holland puumurit
- County 6-syl.



SIIRTO-PUMPPU

F82006984

82006984

- sähköinen
- sopii: 8160, 8260, 8360, 8560, M100, M115, M135, M160

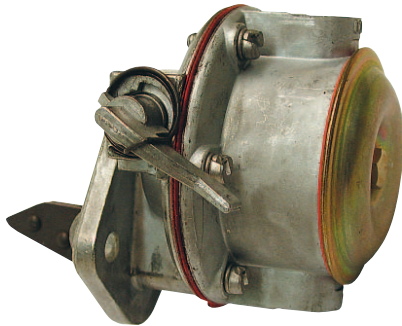

SIIRTOPUMPPU

V550

83991467

- 655, 754, 764, 774, 944, 964, 974, 1164, 3000, 3600, 5000, 5110, 5610, 5900, 6410, 6600, 6610, 6700, 6710, 6810, 7000, 7100, 7200, 7410, 7600, 7610, 7700, 7710, 7810, 7910, 8000, 8200, 8210, 8530, 8600, 8630, 8700, 8730, 8830, 9000, 9200, 9600, 9700, TW5, 10, 15, 20, 25, 30, 35



TANKIN KORKKI

V711

83961128

- 550, 555, 655, 2000, 2100, 2110, 2120, 2300, 2310, 2600, 2610, 2810, 2910, 3000, 3055, 3100, 3120, 3150, 3230, 3300, 3310, 3330, 3400, 3430, 3600, 3610, 3900, 3910, 3930, 4000, 4100, 4110, 4130, 4140, 4200, 4330, 4340, 4400, 4410, 4500, 4600, 4610, 4630, 4830, 5000, 5030, 5100, 5110, 5200, 5340, 5600, 5610, 5700, 5900, 6410, 6600, 6610, 6700, 6710, 6810, 7000, 7100, 7200, 7410, 7600, 7610, 7700, 7710, 7810, 7910, 8210, 8530, 8600, 8630, 8700, 8730, 8830, 9600, 9700, TW5, 10, 15, 20, 25, 30, 35



LASIKUPIT

V48/2

- Super Major
- korkeus 60 mm, ø 53 mm, tiiviste V750 (44 x 54 mm)



SIIRTO-PUMPPU

V551

81711943

- Major, Power Major 1952-8/1961

KORJAUSSARJA V551A

- sisältää sihdin, tiivsteen ja lasikupin

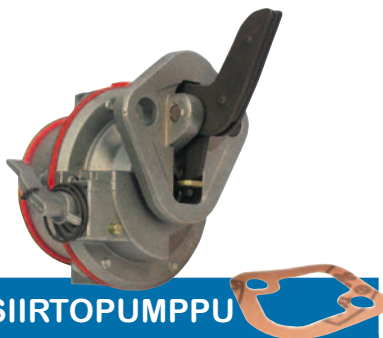

SIIRTOPUMPPU

V552

81711941

- Super Major 8/1961→



SIIRTOPUMPPU

V553

81718195

- Dexta, Super Dexta

01.12.2009

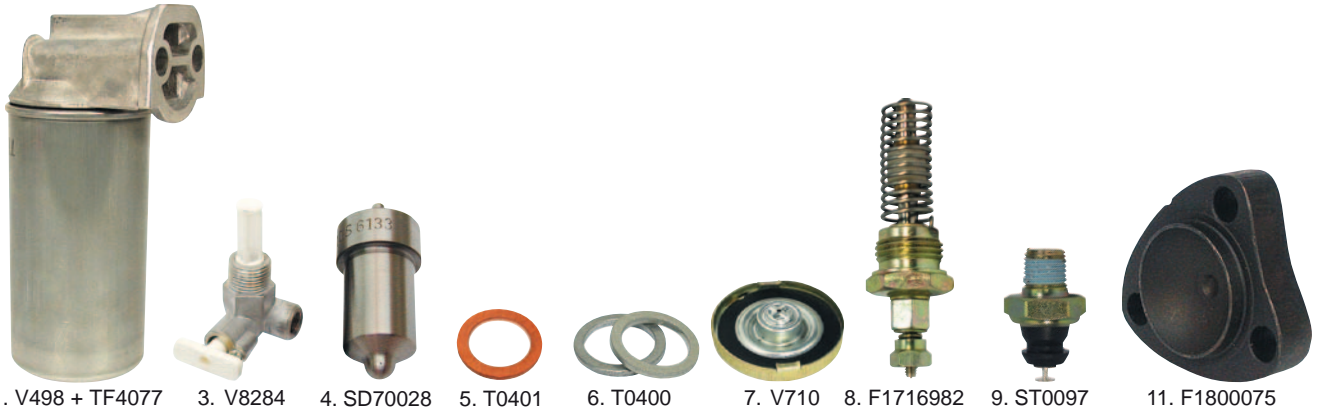

1. V498 + TF4077 3. V8284 4. SD70028 5. T0401 6. T0400 7. V710 8. F1716982 9. ST0097 11. F1800075

OSA	DEXTA	SUPER DEXTA	MAJOR	POWER MAJOR	SUPER MAJOR
1. Täyd. öljynsuodatin	V498 + TF4077/DFP554408 81718968	V498 + TF4077/DFP554408 81718968			
2. Tankin korkki	V710 81718153	V710 81718153	V710 81718153	V710 81718153	V710 81718153
3. Polttoainehana			V8284	V8284	V8284
4. Suuttimen kärki	SD49133 81718687	SD49133 81718687	SD70028 81714498	SD70028 81714498	SD70028 81714498
5. Suuttimen aluslevy	T0401 81716268	T0401 81716268	T0402 81806142	T0402 81806142	T0402 81806142
6. Ylivuotoputken aluslevy	T0400 81821105	T0400 81821105	T0400 81821105	T0400 81821105	T0400 81821105
7. Moottoriöljykorkki	V710	V710	V710	V710	V710
8. Hehkutulppa	F1716982 81716982	F1716982 81716982			
9. Öljykello	ST0097 81873524	ST0097 81873524		ST0097 81873524	ST0097 81873524
10. Puolipuristimen stefa			F1707264 81707264	F1707264 81707264	F1707264 81707264
11. Etukammio	F1800075 81800075	F1800075 81800075			
12. Alipainekalvo	F1716957 81716957		F1714474 81714474	F1714474 81714474	F1714474 (c) 81714474

c - osittain, vain malleihin joissa on alipainesäädin

26.09.2011



V273

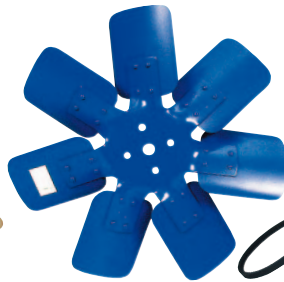

F1829494



F3910825



F0259



V495



F1820903



T4522



F1805624

Katso tuulettimen hihnojen vertailutaulukko Tarvikeluettelon sivulta T6.16c.

TRAKTORI-MALLI	KORJAUS-SARJA	TUULET-TIMEN HIHNA	LATURIN HIHNA	TUULET-TAJAN SIIVET	HANA	TERMOS-TAATTI	TERMOS-TAATTI-KOTELON KANSI	TIIVISTE KOTE-LOON
2000, 3000, 4000, 5000, 7000	V273 (a) 83914014 V8269 (b) 83926011	AVX13-1400 (e) 81827336			V495 81465471	V8283 83913835	F1820903 81820903	F1805624 81805624
8000, 9000		AVX13-1500 83910825	AVX13-1400 (e) 81827336		V495 81465471	T4522 87800842		
2600, 3600, 4100, 4600	V8269 83926011	AVX13-1400 (e) 87800127			V495 81465471	V8283 83913835	F1820903 81820903	F1805624 81805624
5600, 5700, 6600, 6700, 7600, 7700	V8269 (c) 83926011 F0258 (d) 83926012	AVX13-1400 (e) 87800127		F1829494 (f) 81829494 F3918898 83918898	V495 81465471	V8283 83913835	F1820903 81820903	F1805624 81805624
8200, 8600		AVX13-1400 (e) 81827336			V495 81465471	T4522 87800842		
8700, 9700		AVX13-1500 83910825	AVX13-1400 83949803		V495 81465471	T4522 87800842		
3910, 4110, 4610	V8269 83926011	AVX13-1400 (e) 87800127			V495 81465471	V8283 83913835	F1820903 81820903	F1805624 81805624
5610, 6610, 6710	F1864001 (g) 81864001 V8269 (c) 83926011 F0258 (d) 83926012	AVX13-1400 (e) 87800127		F1829494 (f) 81829494 F3918898 83918898	V495 81465471	V8283 83913835	F1820903 81820903	F1805624 81805624
6410, 6810, 7610, 7710	F1864001 (g) 81864001	AVX13-1150 83963768	AVX13-0775 86514616		V495 81465471	V8283 83913835	F1820903 81820903	F1805624 81805624
7810, 7910, 8210	F1864001 (g) 81864001	AVX13-1500 83910825	AVX13-0800 (g) 83949803		V495 81465471	T4522 87800842		
3230, 3430, 3930, 4130, 4630, 4830, 5030		AVX13-1400 (e) 87800127			V495 81465471		F1820903 81820903	F1805624 81805624
8530, 8630, 8730, 8830		AVX13-1500 83910825	AVX13-1400 83949803		V495 81465471	T4522 87800842		
5640, 6640, 7740		F82850751 82850751 F82850752 (h) 83910825			V495 81465471	T4522 87800842		
7840, 8240, 8340		F82850750 82850750 F82850752 (h) 83910825			V495 81465471	T4522 87800842		
TW5, TW10, TW15, TW20, TW25, TW30, TW35		AVX13-1500 83910825	AVX13-1400 83949803		V495 81465471	T4522 87800842		
COUNTY 654, 754	V273 83914014	AVX13-1400 (e) 81827336			V495 81465471	V8283 83913835	F1820903 81820903	F1805624 81805624
COUNTY 764, 774, 964, 974, 550, 555	V273 83914014	AVX13-1400 (e) 87800127			V495 81465471	V8283 83913835	F1820903 81820903	F1805624 81805624
COUNTY 1164, COUNTY 1184		AVX13-1500 83910825	AVX13-1400 83949803		V495 81465471	T4522 87800842		
1720, 4830, 7610, 7710, 7740, 7810, 7840, 8160, 8210, 8240, 8260, 8340, 8360, 8530, 8560, 8630, 8670, 8730, 8770, 8830, TW5, 10, 15, 20, 25, 30, 35						VPE3405 87800842		
TS80, TS90, TS100, TS110, TS115		F82850751 82850751 F82850752 (h) 83910825					T4522 87800842	

a - vesipyörän Ø 89 mm vuosimallit 65-75
b - vesipyörän Ø 104 mm vuosimallit 75→
c - yksiurainen siivapyörä
d - kaksipurainen siivapyörä

e - pyörittää sekä tuuletinta että laturia
f - F1829494 7-lapainen n. 41 cm
F3918898 6-lapainen n. 41 cm

g - viskoosikytkimellä oleva pumppu 11/88- 2-urainen siivapyörä
h - ilmastointilaitteella
k - F0707 4-lapainen n. 40 cm (5600, 6600)

VESIPUMPPU

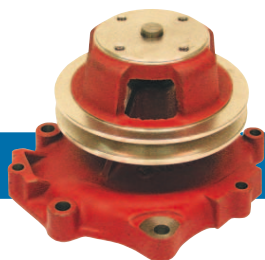

V8268

EAPN8A513F, 83926002

- 2000, 2100, 2110, 2120, 2150, 2300, 2310, 3000, 3055, 3100, 3120, 3150, 3190, 3300, 3310, 3400, 3500, 3550, 4000, 4100, 4110, 4140, 4190, 4200, 4400, 4410, 4500, 4600, 5000, 5100, 5190, 5200, 7000, 7110, 7200, 2600, 3600, 3900, 4100, 4600, 5600, 5700, 6600, 6700, 7600, 7700, 2310, 2610, 2810, 2910, 3610, 3910, 4110, 4610, 5610, 5900, 6610, 6710, 7610, 7710
- pultin reiät 4x10,9 mm, 4x8,9 mm
- V8268A Economic-malli

VESIPUMPPU

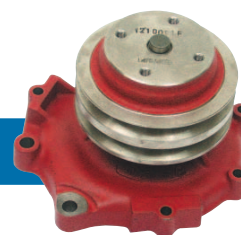

F0547

EJPN8A513BA, 81863835, 83961310

- TW5, TW10, TW15, TW20, TW25, TW30, TW35, 7810
- pultin reiät 4x11,8 mm, 4x8,9 mm

VESIPUMPPU

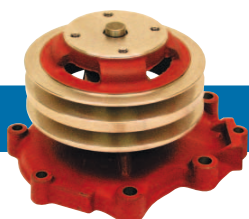

F0257

EAPN8A513E, 83926001

- 2310, 2400, 2610, 2810, 2910, 3600, 3610, 3900, 3910, 4100, 4110, 4600, 4610, 5600, 5700, 6600, 6700, 7600, 7700, 5110, 5610, 5900, 6610, 6710, 7610, 7710
- pultin reiät 4x10,9 mm, 4x8,9 mm

VESIPUMPPU



F0548

E6NN8A513DC, 81863898

- 2310, 2610, 2810, 2910, 3610, 3910, 4110, 4610, 5610, 5900, 6610, 6710, 7610, 7710, 3230, 3430, 3930, 4130, 4630, 5030
- pultin reiät 4x11,8 mm, 4x8,9 mm (3/1990→)

VESIPUMPPU



F0491

EAPN8A513G, 81863921

- 7910, 8210, 8530, 8630, 8730, 8830, 8700, 9700, TW5, TW10, TW15, TW20, TW25, TW30, TW35
- pultin reiät 4x10,9 mm, 4x8,9 mm

VESIPUMPPU

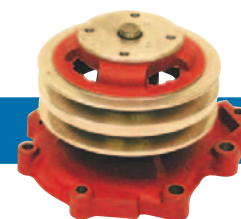

F0549

EGPN8A513CA, 81863837

- 2310, 2610, 2810, 2910, 3610, 3910, 4110, 4610, 5610, 5900, 6610, 6710, 6810, 7610, 7710
- pultin reiät 4x11,8 mm, 4x8,9 mm (3/1990→)

VESIPUMPPU

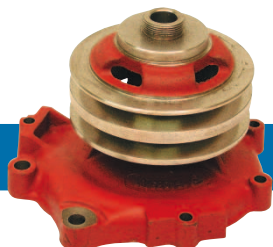

F0540

E7NN8A513CE, 81863830

- 5110, 5610, 6410, 6610, 6810, 7610, 7710, 7810
- pultin reiät 4x11,8 mm, 4x8,9 mm

VESIPUMPPU



T3756

99454833

- TN65F, TN75F, TN95F, L60, L65, L75, L85, L95, TL70, TL80, TL90, TL100, TN55, TN65, TN75, TN90
- 1/1996→

VESIPUMPPU



F0542

81869617, 81869616

- 5640, 6640, 7740, 7840, 8240, 8340, TS80, TS90, TS100, TS110, TS115

VESIPUMPPU

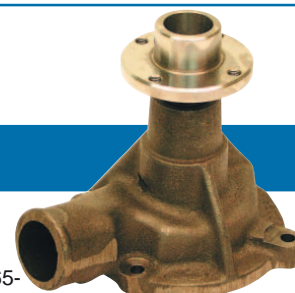

F5004985

85004985, 1529114, EPW-28

- teollisuusmoottorit 2714, 1965-metsäkoneet, puimurit, kuorma-autot
- "kello 17"

22.10.2010



OSA	DEXTA	SUPER DEXTA	MAJOR	POWER MAJOR	SUPER MAJOR
1. Vesipumppu	V268 81718104	V268 81718104	V274 82847510	V274 82847510	V274 82847510
2. Vesipumpun korjaussarja	V270 81844417	V270 81844417	V269 81711772	V269 81711772	V269 81711772
3. Ylävesiletku	V486 81718085	V485 81805632	V480 (c) 81718084	V480 (c) 81718084	V480 (c) 81718084
4. Alavesiletku	V487 81718088	V487 81718088	V481 (c) 81718086	V481 (c) 81718086	V481 (c) 81718086
5. Täyttöletku	V489 81718101	V489 81718101	V482 (c) 81718097	V482 (c) 81718097	V482 (c) 81718097
6. Vesiletku pumpulta lohkon	V815 81716946	V815 81716946			
7. Termostaatti	V8283 83913835	V8283 83913835	V8283 83913835	V8283 83913835	V8283 83913835
8. Tuulettimen hihna	AVX13-1150 81718146	AVX13-1150 81718146	AVX13-1150 81718146	AVX13-1150 81718146	AVX13-1150 81718146
9. Korkki	V570 81711548	V570 81711548	V570 81711548	V570 81711548	V570 81711548
10. Hana	V495 81465471	V495 81465471	V495 81465471	V495 81465471	V495 81465471
11. Ilmanpuhdistajan letku	F1807640 81807640	F1807640 81807640		F1718544 81718544	F1718544 81718544
12. Tuulettajan siipi			V10502	V10502	V10502
13. Lohkon pakkastulppa			F3416689	F3416689	F3416689

c - sopiva letkunside LSCX960

HIHNAKIRISTIN

F1015

87800708, 87801689, F1NN6B209AA
- 5640, 6640, 7740, 7840, 8240, 8340

B1.23

Alkuperäisnumerot ovat ainoastaan vertailua varten, eivätkä tarkoita, että tuotteet ovat alkuperäisiä. Taulukoissa esiintyvät kuvat ovat viitteellisiä.

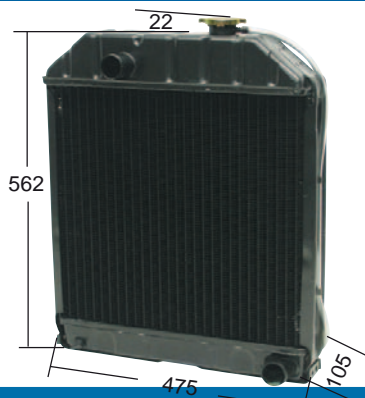

JÄÄHDYTIN

F0099

83990194

- sopivuus: Ford 2000, 3000, 3600, 3910, 4000, 4100, 4110, 4600, 4610
- kokonaiskorkeus 584 mm

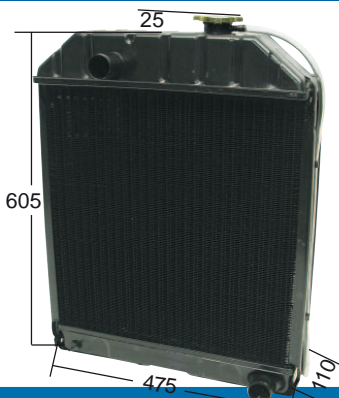

JÄÄHDYTIN

F0100

C7NN8005L, 81817280

- sopivuus: Ford 5000, 5600, 6600
- kokonaiskorkeus 630 mm



JÄÄHDYTIN

F0661

957E8005

- sopivuus: Dexta

JÄÄHDYTIN

F0498

 83993346,
E0NN8005GC15M

- sopivuus: Ford 5110, 5610, 6410, 6610, 6710, 6810, 7410, 7610, 7710
- kokonaiskorkeus 643 mm
- varustettu öljyn lauhduttimella



JÄÄHDYTIN

F0098

E1ADDN8005

- sopivuus: Power Major, Super Major



a - 2 kpl/traktori



V491



V492



F0256



V495

TRAKTORI-MALLI	YLÄ-VESILETKU	ALA-VESILETKU	KORKKI	HANA
2000, 3000, 3600, 4000, 4100, 4600 3910, 4110, 4610	V491 83907414	V493 81805637	F0256 80076896	V495 81465471
5000, 5600, 6600, 6700, 7000, 7600 6410, 5610, 6610, 7410, 7610	V491 83907414	V492 81805638	F0256 80076896	V495 81465471
7710, 7700 7810	F0260 83905554 VPE4140 83961073	F0261 83909073		V495 81465471
231, 2310, 233, 2600, 2610, 2810, 2910, 2N, 3230, 333, 334, 3430, 3435, 3610, 3900, 3930, 3935, 4130, 4135, 4630, 4830, 4835, 5100, 5110, 550, 555, 5635, 5700, 5900, 655, 8N, 9N				V495 81465471

JÄÄHDYTINVEDEN SUODATIN

F3987767

- 2310, 2910, 3230, 3430, 3610, 3910, 3930, 4130, 4610, 4630, 4830, 5030, 5110, 5610, 6410, 6610, 6710, 6810, 7410, 7610, 7710

F89672301

- 7810, 7910, 8210, 8530, 8630, 8730, 8830, TW15, TW25, TW35, TW5

F83971970

- 8160, 8260, 8360, 8560

JÄÄHDYTIN-NESTEEN LISÄAINE

F3958745

83958745

- syöpymisen estoon

PAKKASTULPAT

F3934899	83934899	16,2 mm
F0264	81821893	22,27 mm
F3957021	83957021	29 mm
MF0370		32,2 mm
MF0371		35,4 mm
F0266	83957023	38,5 mm
F0265	83957024	39,95 mm
F3416689		41,27 mm
F0267	83957025	44,75 mm

21.09.2009

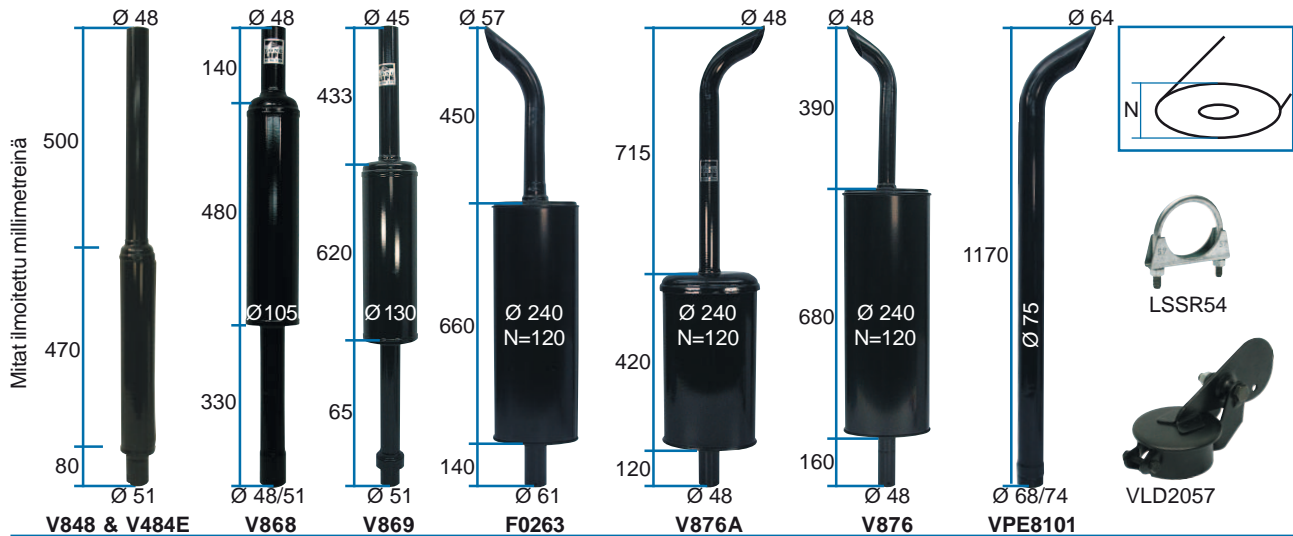

TRAKTORIMALLI	PAKOPUTKI	KIRISTIN	HATTU
DEXTA, SUPER DEXTA	V848, V848E (a) 81717576	LSSR54	VLD2054 83946847
MAJOR, POWER MAJOR, SUPER MAJOR	V868 81717571		VLD2054 83946847
2000, 3000, 4000, 5000, COUNTY 654, 754	V869 81817063		VLD2054 83946847
7000, 7710, 7600, 7700, COUNTY 944, 964	F0263 83949814	LSSR65	VLD2057 83946846
3600, 4100, 4600	V876A 83949817	LSSR54	
5600, 5610, 6600, 6700	V876 83958580	LSSR54	
3610, 3910, 4110, 4610, 3430, 3930, 4630	V876A 83949817	LSSR54	
5610, 6610, 7610, 7710, 6410, 6810, 6710	F0263 83949814	LSSR65	VLD2057 83946846
7810, 8210 (-82-9/85), 7910	F0263 83949814	LSSR65	VLD2057 83946846
40-sarja pystyputki	VPE8101 82004294		

a - maalattu



V842



F1712052



F1712045

TRAKTORI-MALLI	MUTKA	PAKO-SARJA	PAKO-PUTKEN TIIVISTE	IMU-JA PAKOSARJAN TIIVISTE
DEXTA	voidaan korvata yhdistelmällä	V005 MF0001 V848, V848E LSSR54		
SUPER DEXTA		pakosarjan mutka pakosarja pakoputki kiristin		
MAJOR 52-4/57	V842 81796352		F1712052 81712052	F1712044 (a) 81712044
POWER MAJOR 5/57→	V842 81796352		F1712052 81712052	F1712045 (a) 81712044
SUPER MAJOR	V842 81796352		F1712052 81712052	F1712045 (a) 81712044

a - tarvitaan 2 kpl / moottori

B1.25

Alkuperäisnumerot ovat ainoastaan vertailua varten, eivätkä tarkoita, että tuotteet ovat alkuperäisiä. Taulukoissa esiintyvät kuvat ovat viitteellisiä.

04.03.2011

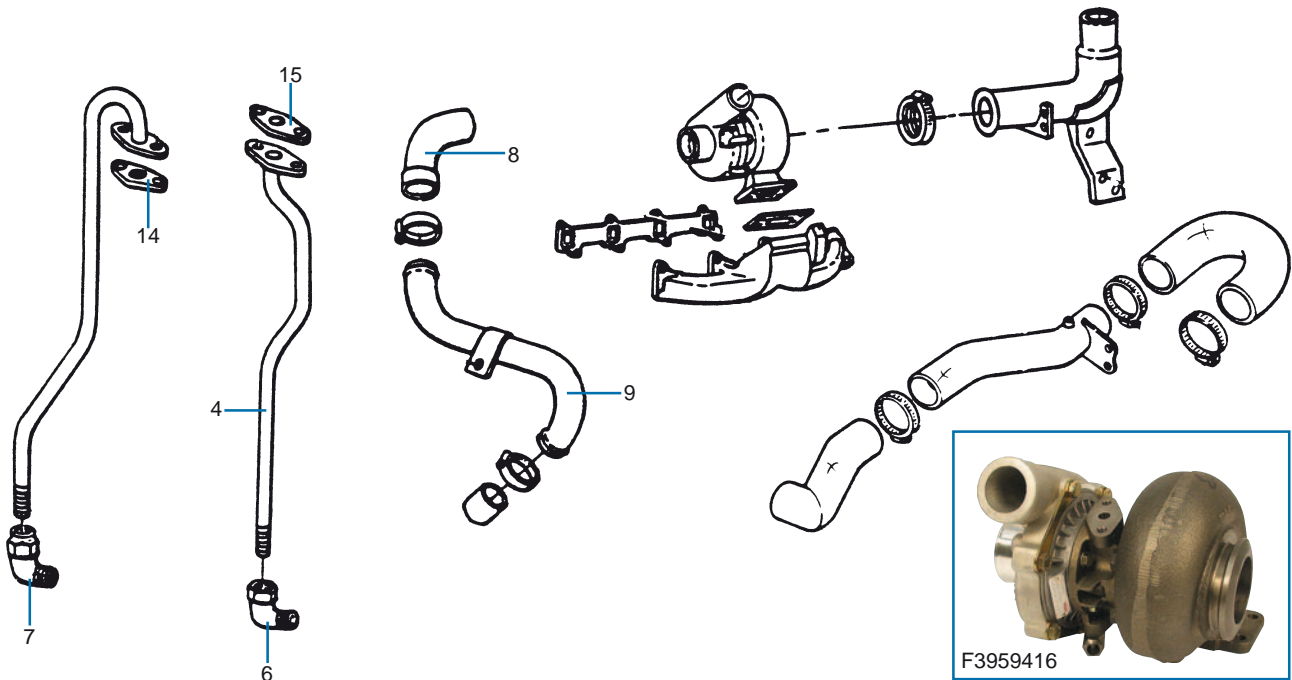

OSA	FORD 5610 1980-6/1987	FORD 5610 7/1987→	FORD 6610 1980-6/1987	FORD 6610 7/1987→	FORD 6410 1991→
4. Öljyputk. paine	F3924077 83924077	F3924077 83924077	F3924077 83924077	F3924077 83924077	F3924077 83924077
6. Kulmaliit. paine	F3924076 83924076	F3924076 83924076	F3924076 83924076	F3924076 83924076	F3924076 83924076
7. Kulmaliit. paluu	F3924082 83924082	F3924082 83924082	F3924082 83924082	F3924082 83924082	F3924082 83924082
8. Kumiputki 90°	F1834256 81834256	F1834256 81834256	F1834256 81834256	F1834256 81834256	F1834256 81834256
9. Ahtoputki	F3919531 83919531	F3959432 83959432	F3919531 83919531	F3959432 83959432	F3959432 83959432
14. Tiiviste paluup.	F3953341 83953341	F3953341 83953341	F3953341 83953341	F3953341 83953341	F3953341 83953341
15. Tiiviste paine	F3959841 83959841	F3959841 83959841	F3959841 83959841	F3959841 83959841	F3959841 83959841

04.03.2011

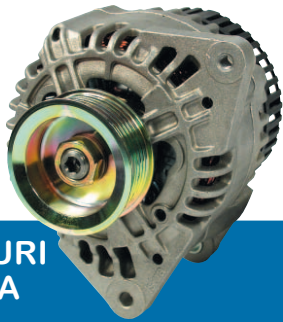

LATURI 100 A

ST0236

82010242, 63321346
- 6-urainen siivapyörä
- 5640, 6640, 7740, 7840, 8240, 8340,
TS80, TS90, TS100, TS110, TS115,
TS120

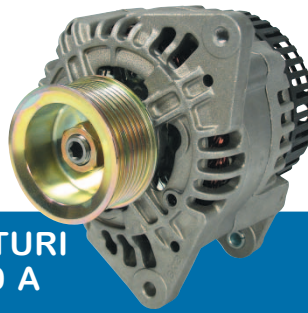

LATURI 100 A

ST0237

82010243, 63321347
- 8-urainen siivapyörä
- 5640, 6640, 7740, 7840, 8240, 8340,
8160, 8260, 8360, 8560, M100, M115,
M135, M160, TM115, TM125, TM135,
TM150, TM165, TS80, TS90, TS100,
TS110, TS115, TS120

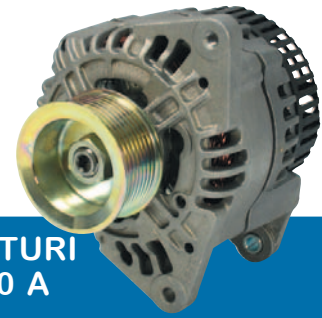

LATURI 120 A

ST0238

82014508, 63321753
- 8-urainen siivapyörä
- TM115, TM120, TM125, TM130,
TM135, TM140, TM150, TM155,
TM165, TM175, TM190

ST0001



LATURI TASAVIRTA

ST0001

81806433
- 22 A
- tyyppi "Pikkulucas C40"
- teho 300 W
- LRD100
- Majorit ja
Dextat

ST0003

81806433
- suljettu
- 11 A
- LRD101
- Majorit ja
Dextat

ST0002

81816845
- Ford malli
- 22 A
- tyyppi "Pikkulucas C40T"
- teho 300 W
- LRD103
- 2000, 2110, 2120, 2150, 2300, 2310,
3000, 3055, 3100, 3110, 3120, 3150,
3310, 3330, 3400, 3500, 3550, 4000,
4100, 4110, 4140, 4200, 4330, 4340,
4400, 4410, 4500, 5000, 5100, 5200,
5340, 5500, 7000, 7100, 7200, 8200,
9200

LATURI VAIHTOVIRTA 45 A

ST0005

83961474
- 18 ACR
- teho 630W
- 2600, 2610, 2910, 3600, 3610, 3900, 3910, 4100, 4110,
4600, 4610, 5110, 5600, 5610, 6410, 6600, 6610, 6700,
6710, 6810, 7410, 7600, 7610, 7700, 7710, 7810, 7910,
8210
- jännitteen säädin **ST0005-10** (VR9001A)

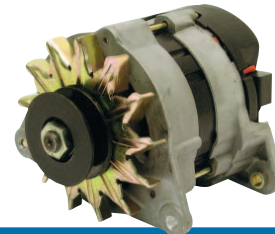

LATURI VAIHTO- VIRTA 70 A

ST0215

81868798
- Ford 100 ja 10 -sarja
- w-liitin
- teho 910 W
- sisältää säätimen, siivan ja tuulettimen
- akselin koko \varnothing 15 mm, hihnaura 12,5 mm
- 3430, 3930, 4130, 4630, 4830, 5030, 5110, 5610, 5900,
6410, 6610, 6710, 6810, 7610, 7710, 7810, 8210
- jännitteen säädin **ST0215-10** (AL1751)



LATURI VAIHTO- VIRTA 65 A

ST0210

81868798
- Lucas Plus PAC NAP 900
- yleismalli useampien 12 V järjestelmien 28-65 A tehoisten latureiden
tilalle hlö- ja tavara-autoihin, traktoreihin ja jopa teollisuuskäyttöön
- teho 910 W
- 5-napainen
- hihnaura 13,5 mm
- sisältää säätimen, siivan ja tuulettimen
- liitäntä digitaaliselle ja w-liittimellä sähköiselle kierroslukumittarille
- 3430, 3930, 4130, 4630, 4830, 5030, 5110, 5610, 5900, 6410, 6610,
6710, 6810, 7610, 7710, 7810, 8210
- jännitteen säädin **ST0215-10** (AL1751)

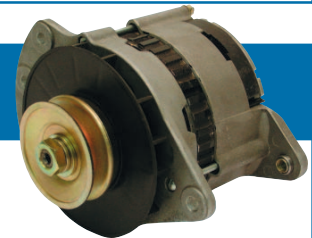

04.03.2011



STARTTIMOOTTORI

ST0034A

81712422

- Majorit

HUOM! Alkuperäistä starttia tehokkaampi malli varustettu solenoidilla kuten kuvassa. Käytä painonappikatkaisinta til:no **ST0205**.

ST0038

- Dextat

STARTTI-MOOTTORI

ST0235

82005342

- 5640, 6640, 7740, 7840, 8160, 8240, 8260, 8340, 8360, 8560, TS80, 90,100, 110

STARTTIMOOTTORI

ST0035A

83981923

- 550, 555, 655, 2000, 2100, 2110, 2120,2150, 2300, 2310, 2600, 2610, 2810, 2910, 3000, 3055, 3100, 3120, 3150, 3230, 3300, 3310, 3330, 3400, 3430, 3500, 3550, 3600, 3610, 3900, 3910, 3930, 4000, 4100, 4110, 4130, 4140, 4200, 4330, 4340, 4400, 4410, 4600, 4610, 4630, 4830, 5000, 5030, 5100, 5110, 5200, 5340, 5600, 5610, 5700, 5900, 6410, 6600, 6610, 6700, 6710, 6810, 7000, 7100, 7200, 7410, 7600, 7610, 7700, 7710, 7810, 7910, 8000, 8200, 8210, 8530, 8600, 8630, 8700, 8730, 8830, 9000, 9200, 9600, 9700, TW5, 10, 15, 20, 25, 30, 35, Major, Power Major, Super Major



STARTTIMOOTTORI

ST35220

83981923

-Ford 2000, 2100, 2110, 2120, 2150, 2300, 2310, 2600, 2610, 2810, 2910, 3000, 3055, 3100, 3120, 3150, 3230, 3300, 3310, 3330, 3400, 3430, 3500, 3550, 3600, 3610, 3900, 3910, 3930, 4000, 4100, 4110, 4130, 4140, 4200, 4330, 4340, 4400, 4410, 4600, 4610, 4630, 4830, 5000, 5030, 5100, 5110, 5200, 5340, 550, 555, 5600, 5610, 5700, 5900, 6410, 655, 6600, 6610, 6700, 6710, 6810, 7000, 7100, 7200, 7410, 7600, 7610, 7700, 7710, 7810, 7910, 8000, 8200, 8210, 8530, 8600, 8630, 8700, 8730, 8830, 9000, 9200, 9600, 9700, Major, Power Major, Super Major, TW10, TW15, TW20, TW25, TW30, TW35, TW5
-LRS212
-Lucas MG50G
-oikea puoli



STARTTIMOOTTORI

ST0172

NH L65, L75, L85, L95, TL100, TL65, TL70, TL80, TL90

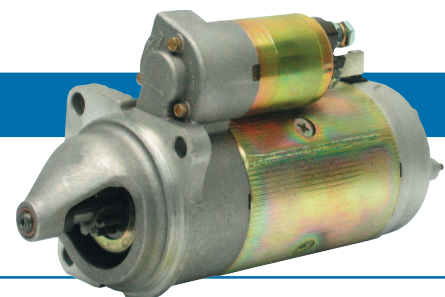

12.01.2009



ST0054



F3960406



ST0048

TRAKTORI-MALLI	SOLENOIDI	HIILI-SARJA
2000, 3000, 4000, 5000, 7000	ST0054 (d) 83912208	ST0047 (a) 81812553 ST0048 (f)
3600, 4100, 4600, 5600,	ST0054 (d) 83912208	ST0047 (a) 81812553
6600, 6700, 7600, 7700	ST0054 (d) 83912208	ST0048 (f)
3910, 4110, 4610, 5610,	ST0054 (d) 83912208	ST0047 (a) 81812553
6610, 7610, 7710	F3960406 (d) 83960406	ST0048 (f)



ST0062



TRAKTORI-MALLI	BENDIX-RATAS	HELA-SARJA	VIRTA-LUKKO	HEHKU-TULPPA
2000, 3000, 4000, 5000, 7000	ST0062 (d) 81826195	ST0051 83949368	ST0088 81871583	MF0441 81806046
3600, 4100, 4600, 5600, 6600, 6700, 7600, 7700	ST0062 (d) 81826195	ST0051 83949368	ST0088 81871583	MF0441 81806046
3910, 4110, 4610, 5610,	ST0229 (c,d)	ST0051 83949368	ST0088 81871583	MF0441 81806046
6610, 7610, 7710	ST0062 (d) 81826195		ST0088 81871583	MF0441 (e) 81806046

LUCAS 18 ACR VAIHTOVIRTALATURIN OSAT

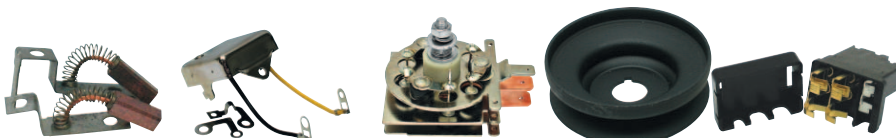

HIILI-SARJA	SÄÄDIN	DIODI-SARJA	SIIVA-PYÖRÄ	LIITIN-SARJA
ST0024 81845965	ST0020 81846029	ST0021	ST0022 9,5 x 63 mm	ST0025

TRAKTORI-MALLI	PÄÄ-JOHTOSARJA
5000 (1965-1/1968)	F1811306 81811306
5000, 7000	F1830068 81830069
3600, 4100, 4600 4/1976→	F3924406 83924406
5600, 6600, 7600, 5610, 6610, 7610	F3924402 83924402

VIRTA-LUKKO/ VALOKATKAISIN

ST0089
- Dexta, Major

- a - koko 8 x 19 mm
- c - jyrkkäurainen
- d - katso myös Tarvikeluettelon välikko 2
- e - →10/1982
- f - koko 9 x 20 mm
- g - 2 liitäntäjohdolla



08.05.2009

PIKKULUCAS TASAVIRTALATURIN VARAOSAT

DEXTAT JA MAJORIT

HIILI-SARJA

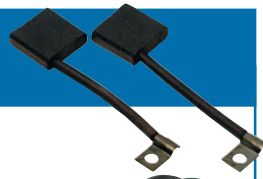

ST0013
81819321

VETOPÄÄN LAAKERI



L6302-2RS

HIILIPÄÄN PUSLA



ST0016

SIIVAPYÖRÄ



ST0009
81712328

- 2000, 2110, 2120, 2150, 2300, 2310, 3000, 3055, 3100, 3120, 3150, 3310, 3330, 3400, 3500, 3550, 4000, 4100, 4110, 4140, 4200, 4330, 4340, 4400, 4410, 4500, 5000, 5100, 5200, 5340, 5500, 7000, 7100, 7200, 8200, 9200, Dexta, Major, Power Major, Super Dexta, Super Major

RELE PELTIKUORINEN



ST0083

81718301
- Major, Power Major, Super Major

STARTTIMOOTTORIN SUOJAKUMI



ST0167

- Dexta, Major, Super Dexta, Super Major

PIKKULUCAS FORD TASAVIRTALATURIN OSAT

SIIVA-PYÖRÄ



ST0009
81712328

- 2000, 2110, 2120, 2150, 2300, 2310, 3000, 3055, 3100, 3120, 3150, 3310, 3330, 3400, 3500, 3550, 4000, 4100, 4110, 4140, 4200, 4330, 4340, 4400, 4410, 4500, 5000, 5100, 5200, 5340, 5500, 7000, 7100, 7200, 8200, 9200, Dexta, Major, Power Major, Super Dexta, Super Major

HIILI-SARJA

ST0014
81818231

- 2000, 2110, 2120, 2150, 2300, 2310, 3000, 3055, 3100, 3120, 3150, 3310, 3330, 3400, 3500, 3550, 4000, 4100, 4110, 4140, 4200, 4330, 4340, 4400, 4410, 4500, 5000, 5100, 5200, 5340, 5500, 7000, 7100, 7200, 8200, 9200, Dexta, Major, Power Major, Super Dexta, Super Major

RELE



ST0084
81824174

- 2000, 2100, 2120, 2150, 2300, 2310, 3000, 3055, 3100, 3110, 3120, 3150, 3300, 3310, 3330, 3400, 3500, 3550, 4000, 4100, 4110, 4140, 4200, 4330, 4340, 4400, 4410, 4500, 5000, 5100, 5200, 5340, 7000, 7100, 7200

TUNTIMITTARIN FIIBERRATAS



ST0019
81812583

- 2000, 2110, 2120, 2150, 2300, 2310, 3000, 3055, 3100, 3120, 3150, 3310, 3330, 3400, 3500, 3550, 4000, 4100, 4110, 4140, 4200, 4330, 4340, 4400, 4410, 4500, 5000, 5100, 5200, 5340, 5500, 7000, 7100, 7200, 8200, 9200, Dexta, Major, Power Major, Super Dexta, Super Major

KIERROSLUKUMITTARIN KULMAYHDE

F1812582

- 2000, 2110, 2120, 2300, 2310, 3000, 3055, 3100, 3120, 3150, 3300, 3310, 3330, 3400, 3500, 3550, 4000, 4100, 4110, 4140, 4200, 4330, 4340, 4400, 4410, 4500, 5000, 5100

LUCAS M45 PAKKOBENDIX VARAOSAT

DEXTAT JA MAJORIT



HIILI-SARJA

ST0047
81829254



KENTTÄ-KÄÄMIT

ST0045
81712454



PUSLASARJA

ST0049
12,7 mm



SOLENOIDI KAAPELIN VÄLIIN

ST0050
14 mm

ST0053
76766

B1.29

26.09.2011



TRAKTORI-MALLI	ÖLJYN-SUODATIN	POLTO-AINE-SUODATIN	ILMANSUODATIN ULOMPI	ILMANSUODATIN SISEMPI	HYDRAULIIKKA-SUODATIN	OHJAUKSEN SUODATIN	OHJAAMON SUODATIN
DEXTA benssiini	TF5002 1715758						
DEXTA SUPER DEXTA	TF5007 DFP550184 1718968	TF7021 (a) 1715762			F1800792 1800792		
MAJOR -52-1/-56	TF5002 (k) 1715758	TF7021 (a) 1715762			F1802003 1802003		
POWER MAJOR 1/-56-12/-58	TF5038 (k) 1715761	TF7021 (a) 1715762			F1802003 1802003		
SUPER MAJOR 12/-58-64	TF5007 (k) DFP550184 1718968	TF7021 (a) 1715762			F1802003 1802003		
2000, 3000, 4000	TF5014 F81837145 81837145 TF4504 (b) DFP550882 F87800068 87800068	MPCAV296 (x2) DFP556245 (x2) 83937061			F1802002 (c) 1802002	TF5173 (i) 83936985	
2600, 3600, 3900, 4100, 4600	TF4504 DFP550882 F87800068 87800068	MPCAV296 DFP556245 83937061	TF2242 DFP771546 81866927 TF2331 (l) DFP526500 83908364	TF2242-2 DFP181208 83957161 TF2331-2 (l) 83908367	TF4102 DFP551323 F83912256 83912256	TF5173 83936985	TF21063 (f) 83913701
2610, 3610, 3910, 4110, 4610	TF4504 DFP550882 F87800068 87800068	MPCAV296 DFP556245 83937061	TF2231 DFP526505 83908365	TF2231-2 DFP526504 83908360	TF4102 DFP551323 83912256 F83912256 F83912298 (d) 83912298	TF5173 83936985	TF21063 (f) 83913701 TF21237 (g) 83932017
3230, 3430, 3930, 4130, 4630, 4830, 5030	TF4504 DFP550882 F87800068 87800068	MPCAV296 DFP556245 83937061 DFP556287 83917626	TF2231 DFP526505 83908365	TF2231-2 DFP526504 83908360	TF4102 DFP551323 83912256 F83912256 F83912298 (d) 83912298	TF5173 83936985	TF21161 (2) 83990257
4635	TF4085 DFP554407 1909101	TF6206 DFP550588 1930010 FT1930581 (e) 1930581	TF2593 1930587	DFP775300 1930588	FT1930986 1930986	VPJ4509 1909143	TF21182 (2) 82012057
4835, 5635	TF4076 DFP553411 1909102	TF6206 DFP550588 1930010 FT1930581 (e) 1930581	TF2701 DFP828889 1930589	TF2677-2 DFP829333 1930590	FT1930986 (x3) 1930986	VPJ4509 1909143	TF21182 (2) 82012057 F83994694 (m) 83994694
5000	TF5014 F81837145 81837145 TF4504 (b) DFP550882 F87800068 87800068	MPCAV296 (x2) DFP556245 (x2) 83937061			F1802003 (c) 1802003 F86546610 86546610	TF5173 (i) 83936985	

Ks. huomautukset sivulta B1.34

B1.30

Alkuperäisnumerot ovat ainoastaan vertailua varten, eivätkä tarkoita, että tuotteet ovat alkuperäisiä. Taulukoissa esiintyvät kuvat ovat viitteellisiä.

26.09.2011



TRAKTORI-MALLI	ÖLJYN-SUODATIN	POLTO-AINE-SUODATIN	ILMANSUODATIN ULOMPI	ILMANSUODATIN SISEMPI	HYDRAULIIKKA-SUODATIN	OHJAUKSEN SUODATIN	OHJAAMON SUODATIN
5600, 5700, 6600 6700	TF4504 DFP550882 87800068	MPCAV296 DFP556245 83937061	TF2231 (n) DFP526505 83908365 TF2242 (o, v) DFP771546 81866927	TF2231-2 (n) DFP526504 83908360 TF2242-2 (o) DFP181208 81823932	TF4102 DFP551323 F83912256 83912256	TF5173 83936985	TF21063 (f) 83913701
5610	TF4504 DFP550882 87800068	MPCAV296 DFP556245 83937061 DFP556287 83917626 11/88 eteenp.	TF2231 DFP526505 83908365	TF2231-2 DFP526504 83908360	TF4102 (x2) DFP551323 F83912256 83912256	TF5173 83936985	TF21063 (f) 83913701 TF21201 (h) 81863349 TF21237 (g) 83932017
5640, 6640	TF4015 F81879134 81879134	TF6206 DFP550588 87800220	TF2567 82008600 ei turbo 11/91 - 8/94 TF2701 DFP828889 82008596 turbo ja 11/95 eteenpäin	VPD7112 82008601 ei turbo 11/91 - 8/94 TF2677-2 DFP829333 82008597 turbo ja 11/95 eteenpäin	DFP502224 (q) 82005016 F81869132 (r) 81869132 DFP164378 (s) 81863799 F1863229 (t) 81863229 F82003166 (u) 82003166		TF21182 (x2) 82012057 F83994694 (m) 83994694
6410	TF4504 DFP550882 87800068	DFP556287 83917626	TF2242 (v) DFP771546 81866927	TF2242-2 DFP181208 81823932	TF4102 (x2) DFP551323 F83912256 83912256	TF5173 83936985	TF21201 (h) 81863349
6610, 6710	TF4504 DFP550882 87800068	MPCAV296 DFP556245 83937061 DFP556287 83917626 11/88 eteenp.	TF2242 (v) DFP771546 81866927	TF2242-2 DFP181208 81823932	TF4102 (x2) DFP551323 F83912256 83912256	TF5173 83936985	TF21063 (f) 83913701 TF21201 (h) 81863349 TF21237 (g) 83932017
6635, 7635	TF4076 DFP553411 1909102	TF6206 DFP550588 1930010 FT1930581 1930581	TF2701 DFP828889 1930589	TF2677-2 DFP829333 1930590	FT1930986 (x2) 1930986	VPJ4509 1909143	TF21182 (x2) 82012057 F83994694 (m) 83994694
6810	TF4500 DFP554403 F87800083 87800083	DFP556287 83917626	TF2242 (v) DFP771546 81866927	TF2242-2 DFP181208 81823932	TF4102 (x2) DFP551323 F83912256 83912256	TF5173 83936985	TF21201 (h) 81863349
7000	TF5014 F81837145 81837145 TF4500 (b) DFP554403 F87800083 87800083	MPCAV296 DFP556245 83937061	TF2242 (v) DFP771546 81866927	TF2242-2 DFP181208 81823932	F86546610 86546610	TF5173 83936985	
7600, 7700	TF4500 DFP554403 F87800083 87800083	MPCAV296 DFP556245 83937061	TF2242 (v) DFP771546 81866927	TF2242-2 DFP181208 81823932	TF4102 DFP551323 F83912256 83912256	TF5173 83936985	TF21063 (f) 83913701

Ks. huomautukset sivulta B1.34

B1.31

Alkuperäisnumerot ovat ainoastaan vertailua varten, eivätkä tarkoita, että tuotteet ovat alkuperäisiä. Taulukoissa esiintyvät kuvat ovat viitteellisiä.

26.09.2011

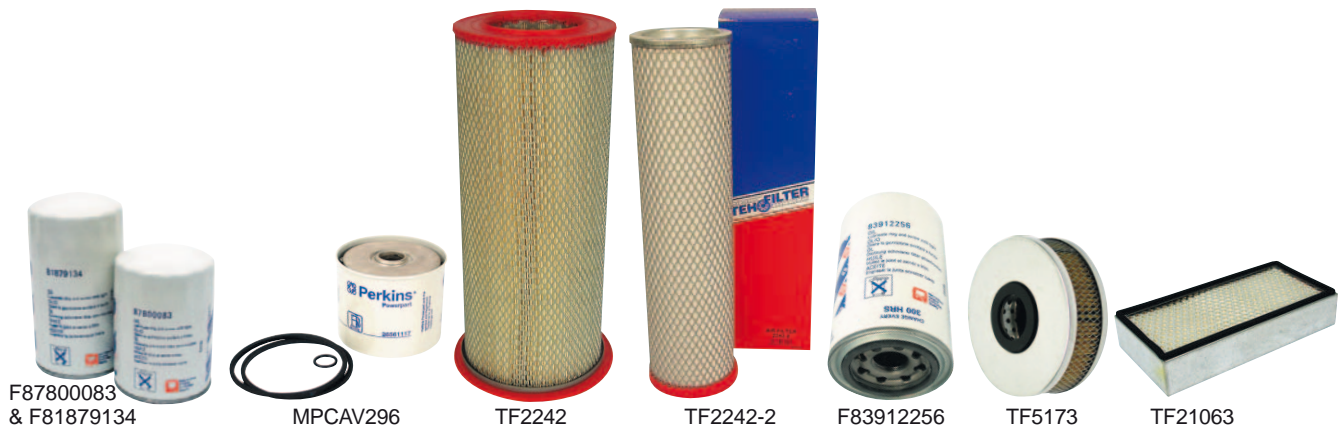

TRAKTORI-MALLI	ÖLJYN-SUODATIN	POLTTO-AINE-SUODATIN	ILMANSUODATIN ULOMPI	ILMANSUODATIN SISEMPI	HYDRAULIILIKKA-SUODATIN	OHJAUKSEN SUODATIN	OHJAAMON SUODATIN
7610, 7710	TF4500 DFP554403 F87800083 87800083	MPCAV296 DFP556245 83937061 DFP556287 83917626 11/88 eteenp.	TF2242 (v) DFP771546 81866927	TF2242-2 DFP181208 81823932	TF4102 DFP551323 F83912256 83912256 F83912298 (d) 3912298	TF5173 83936985	TF21063 (f) 83913701 TF21201 (h) 81863349
7740, 7840, 8240, 8340	TF4015 F81879134 81879134	TF6206 DFP550588 87800220	TF2567 82008600 ei turbo 11/91 - 8/94 F82008596 82008596 turbo ja 11/95 eteenpäin	VPD7112 82008601 ei turbo 11/91 - 8/94	DFP502224 (q) 82005016 F81869132 (r) 81869132 DFP164378 (s) 81863799 F1863229 (t) 81863229 F82003166 (u) 82003166		TF21182 (x2) 82012057 F83994694 (m) 83994694
7810	TF4500 DFP554403 F87800083 87800083 F83986170 83986170 1/90 eteenp.	DFP556287 83917626	TF2242 (v) DFP771546 81866927	TF2242-2 DFP181208 81823932	TF4102 (x2) DFP551323 F83912256 83912256	TF5173 83936985	TF21201 (h) 81863349
7910	F83986170 83986170	DFP556287 83917626	TF2242 (v) DFP771546 81866927	TF2242-2 DFP181208 81823932	TF4102 (x2) DFP551323 F83912256 83912256	TF5173 83936985	TF21063 (f) 83913701 TF21201 (h) 81863349
8000	TF5014 F81837145 81837145	MPCAV296 DFP556245 83937061	TF2242 (v) DFP771546 81866927	TF2242-2 DFP181208 81823932		TF5173 83936985	
8160, 8260	TF4015 F81879134 81879134	F87840591 87840591 F87801341 (j) 87801341 F87840590 (e, aa) 87840590	TF2567 82008600 F82008606 82008606	VPD7112 82008601	DFP502224 (q) 82005016 DFP164378 (s) 81863799		TF21182 (x2) 82012057 F83994694 (m) 83994694
8210	F83986170 83986170	DFP556287 83917626	TF2242 (v) DFP771546 81866927	TF2242-2 DFP181208 81823932	TF4102 (x2) DFP551323 F83912256 83912256	TF5173 83936985	TF21063 (f) 83913701 TF21201 (h) 81863349
8360, 8560	TF4015 F81879134 81879134	F87840591 87840591 F87801341 (j) 87801341 F87840590 (e, aa) 87840590	TF2567 82008600 F82008606 82008606	F82008607 82008607	DFP502224 (q) 82005016 DFP164378 (s) 81863799		TF21182 (x2) 82012057 F83994694 (m) 83994694
8200, 8400 8600,8700					F1017 83913971 86539970 D8NNM9030AA		

Ks. huomautukset sivulta B1.34



FORD, NEW HOLLAND SUODATTIMET



26.09.2011

TRAKTORI-MALLI	ÖLJYN-SUODATIN	POLTTO-AINE-SUODATIN	ILMANSUODATIN ULOMPI	SISEMPI	HYDRAULIIKKA-SUODATIN	OHJAUKSEN SUODATIN	OHJAAMON SUODATIN
8530, TW5	F83986170 83986170	DFP556287 83917626	TF2242 (v) DFP771546 81866927	TF2242-2 DFP181208 81823932	F86546610 86546610 TF4102 DFP551323 F83912256 83912256 F83912298 (d) 83912298	TF5173 83936985	TF21063 (f) 83913701 TF21201 (h) 81863349
8600, 8700	TF5014 F81837145 81837145	MPCAV296 DFP556245 83937061	TF2242 (v) DFP771546 81866927	TF2242-2 DFP181208 81823932		TF5173 83936985	TF21063 (f) 83913701
8630, TW15 8730, TW 25	F83986170 83986170	DFP556287 83917626			F86546610 86546610 TF4102 DFP551323 F83912256 83912256 F83912298 (d) 83912298	TF5173 83936985	TF21063 (f) 83913701 TF21201 (h) 81863349
8670, 8770, 8870, 8970	TF4015 F81879134 81879134						
8830, TW35 TW30	F86546616 86546616	DFP556287 83917626			F86546610 86546610 TF4102 DFP551323 F83912256 83912256 F83912298 (d) 83912298	TF5173 83936985	TF21063 (f) 83913701 TF21201 (h) 81863349
9000, TW20	TF5014 (p) F81837145 81837145 F83986170 83986170	MPCAV296 DFP556245 83937061 DFP556287 83917626				TF5173 83936985	TF21063 (f) 83913701
9600, 9700	TF5014 F81837145 81837145	MPCAV296 DFP556245 83937061				TF5173 83936985	TF21063 (f) 83913701
TW10	TF5014 (p) F81837145 81837145 F83986170 83986170	DFP556287 83917626	TF2242 (v) DFP771546 81866927	TF2242-2 DFP181208 81823932		TF5173 83936985	TF21063 (f) 83913701
TS80, TS90 TS100, TS110	TF4015 F81879134 81879134	F87801285 87801285	F82011402 82011402	VPD7112 82008601	DFP502224 (q) 82005016 DFP164378 (s) 81863799 F81869132 (r) 81869132 F82003166 (u) 82003166		TF21182 (z) 82012057 F83994694 (m) 83994694
TS115	TF4015 F81879134 81879134	TF6206 DFP550588 87800220 F87801285 (y)	F82011402 82011402	VPD7112 82008601	DFP502224 (q) 82005016 DFP164378 (s) 81863799 F81869132 (r) 81869132 F82003166 (u) 82003166		TF21182 (z) 82012057 F83994694 (m) 83994694
TL70A, TL80A, TL90A, TL100A	F87803205 (bb) 87803205	F87803187 (bb) 87803187					
TS100A, TS110A, TS115A, TS125A, TS130A, TS135A	F87803205 (bb) 87803205	F87803187 (x, bb) 87803187					
M100, M115, M135, M160	F81879134 81879134						
TM115, TM120, TM125, TM130, TM135, TM140, TM150, TM155, TM165, TM175, TM190		F87840590 (e) 87840590					
TM120, TM130, TM140, TM155, TM175, TM190		F87803444 (z) 87803444 F87803441 (o) 87803441					
TS110A, TS125A, TS135A		F87803180 (ä) 87803180 F87803197 (ä) 87803197					

Ks. huomautukset sivulta B1.34

**DUAL POWER
SUODATIN**

DFP164381
82003166
- TS90, TS100, TS110, TS115

B1.33

Alkuperäisnumerot ovat ainoastaan vertailua varten, eivätkä tarkoita, että tuotteet ovat alkuperäisiä.
Taulukoissa esiintyvät kuvat ovat viitteellisiä.

SUODATTIMEN MITAT

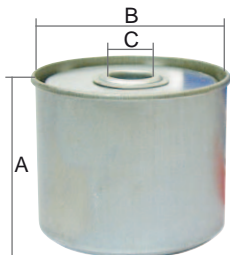

A mm	B mm	C mm	
155	72	33	TF5002
140	72	21	TF5038
114	72	21	TF5007
87	72	33	TF7015
87	72	21	TF7021
85	73	21	TF8017

VAIHTOEHTO ALKUPERÄISPAKKAUKSESSA

TF4500	=	F87800083	(kuvassa)
TF4015	=	F81879134	(kuvassa)
DFP553411	=	FT1909102	
TF4102	=	F83912256	
TF4504	=	F87800068	
TF6206	=	FT1930010	
DFP502224	=	F82005016	
DFP164378	=	F81863799	



Huomautukset sivuille B1.30 - B1.33

- a - hienosuodatin, karkeasuodattimen numero **TF8017**
- b - täysvaihto
- c - hydrauliiikan paluusuodatin nostolaitteikannen alla
- d - lisäpumpun suodatin
- e - vedenerotinsuodatin
- f - Q-ohjaamo 3 kpl 9/1985 asti
- g - Lp-ohjaamo 2 kpl
- h - Ford-ohjaamo 2 kpl 10/1985 eteenpäin
- i - säiliö ja suodatin pumpun yhteydessä
- j - uudempi malli, pa-pumppu suodattimen jalassa
- k - tarkista mitat
- l - 4/1976 eteenpäin
- m - ohut esisuodatin
- n - 4/1976 - 9/1980
- o - 1/1975 - 3/1976 ja 10/1980 eteenpäin
- p - 6/1979 asti

- q - hydraulioöljyn suodatin
- r - hydraulioöljyn suodatin ohjaus / Dual Power SLE mallit
- s - hydraulioöljyn painesuodatin (SLE mallit)
- t - hydraulioöljyn lisäpumpun suodatin SL mallit
- u - Dual Power, vaihteisto 3/1994 eteenpäin
- v - **TF2636** kok.pituus 395 mm, **TF2636** kok.pituus 390 mm
- x - ei sovi malleihin TS125A ja TS135A
- y - sähköinen siirtopumppu
- z - 30 micron suodatin,
malleihin joissa PA-pumppu suodatinrungossa
- å - suodatin, jossa vesisensori, vaihda myös **F87803197**
- ä - vaihda myös **F87803180**
- ö - 5 micron, 8/2005 eteenpäin
- aa- moottorinumeroon FA097480 saakka
- bb- malleihin, joissa yksi suodatin

SYKLONI ESIPUHDISTIN

Esipuhdistin säästää koneen varsinaista ilmapuhdistinta. Syklonissa ilma joutuu pyörivään liikkeeseen ja epäpuhtaudet jäävät syklonin pohjalle. Puhdistettava ajoittain.

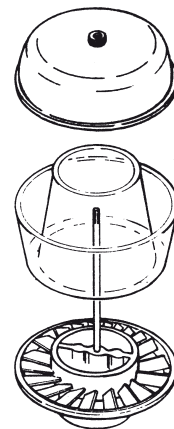

DFH001249

- putkikoko 3"/76 mm
- varalasi **DFP020227**

DFH000820

- putkikoko 3"/76 mm
- varalasi **DFP016330**

DFH000822

- putkikoko 4"/101 mm
- varalasi **DFP016330**

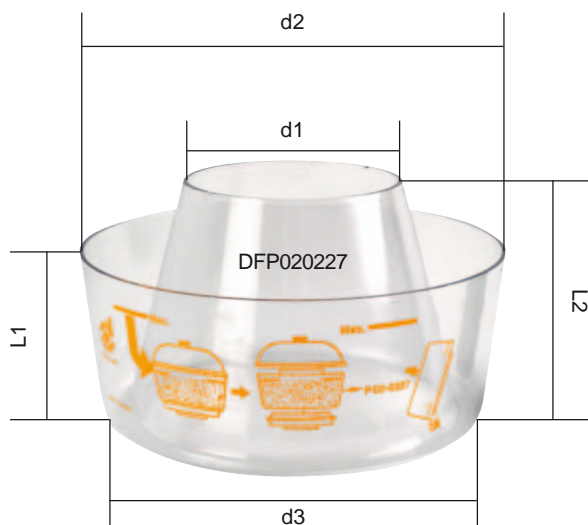

VARALASIT MITTATAULUKKO

MITAT	DFP020227	DFP016330
d1 mm	90	141
d2 mm	183,5	266
d3 mm	140	217,5
L1 mm	77	75,5
L2 mm	106	101,5



FORDSON-TRAKTOREIDEN TÄYDELLINEN VARAOSAKIRJA

KVH134

- koko A5, 40 sivua
- suomenkielinen nide piirroskuvin
- rei'itys mappisäilytystä varten
- tilattavissa erikseen myyntiin