



Kaikkien sylinterien halkaisija 100 mm

TRAKTORI-MALLI	SYLINTERI-LUKU	MOOTTORI-TYYPI
770 Selectamatic	3	AD3/49A
780 Selectamatic	3	AD3/55 355011
880 Selectamatic	3	AD3/55A
885 Synchronomatic	3	AD3/55 355011
990 Selectamatic	4	AD4/47
990 Synchronomatic	4	AD4/49 449001
995 Synchronomatic	4	AD4/55 455051
996 Synchronomatic	4	AD4/55 455071
1190, 1194 DB-Case	3	AD3/55 165004
1200 Selectamatic	4	AD4/55 A4155A
1210 Synchronomatic	4	AD4/55 455009
1212 Synchronomatic	4	AD4/55 455031

TRAKTORI-MALLI	SYLINTERI-LUKU	MOOTTORI-TYYPI
1290 DB-Case	4	AD4/55 2200004
1294 DB-Case	4	AD4/55 220008
1390 DB-Case	4	AD4/55 2200002
1394 DB-Case	4	AD4/55 220103 AD4/55T
1394 T DB-Case	4	AD4/55T
1410, 1412 Synchronomatic	4	AD4/55T 455011
1490 DB-Case	4	AD4/55T 220101
1494 DB-Case	4	AD4/55T 220105
1594 DB-Case	6	AD6/55 330002
1690 DB-Case	6	AD6/55 330001
1690 Turbo DB-Case	6	AD6/55T 330101
1694 DB-Case	6	AD6/55T 330102

20.05.2011



VANHAT MALLIT

TRAKTORI-MALLI	MÄNTÄ	MÄNNÄN RENGASSARJA (yhteen sylinteriin)	PUTKI	PUTKEN O-RENGAS
30, 880 4-syl., 900, 950		T4052 K261069		T4057 062400
990 vm. 61-68 (märillä putkilla)	92,075 mm AD4/47	T4048 K902667	T4055 K906859	T4057 062400



TRAKTORI-MALLI	RUNKOLAAKERISARJA STD	MÄNNÄNTAPIN HELÄ
25D, 30, 880 4-syl., 900, 950		T4064 K31669
990 vm. 61-68	T4062 K928541	T4062A K928554

MOOTTORINKORJAUS

880, 885

- ylikoon mäntä

T4049A	Mäntä 020, sis. renkaat	3 kpl
T4072	Ylätiivistesarja	1 kpl
T4075	Alatiivistesarja	1 kpl
T0016	Kampiakselin etustefa	1 kpl
T4188	Kampiaks. narutiivistepari	1 kpl
T4060	KK-laakerisarja STD	1 kpl
T4063	RK-laakerisarja STD	1 kpl

995,996,1200,1210,1212,1290,1294,1390

- ylikoon mäntä

T4049A	Mäntä 020, sis. renkaat	4 kpl
T4074	Ylätiivistesarja	1 kpl
T4076	Alatiivistesarja	1 kpl
T4041	KK-laakerisarja STD	1 kpl
T4062	RK-laakerisarja STD	1 kpl

880, 885

T4049	Mäntä, sis. renkaat	3 kpl
T4056	Sylinteriputki	3 kpl
T4072	Ylätiivistesarja	1 kpl
T4075	Alatiivistesarja	1 kpl
T0016	Kampiakselin etustefa	1 kpl
T4188	Kampiaks. narutiivistepari	1 kpl
T4060	KK-laakerisarja STD	1 kpl
T4063	RK-laakerisarja STD	1 kpl

995,996,1200,1210,1212,1290,1294,1390

T4049	Mäntä 020, sis. renkaat	4 kpl
T4053	Männänrenkassarja	4 kpl
T4056	Sylinteriputki	4 kpl
T4094	Tiivistesarja täydellinen	1 kpl
T4041	KK-laakerisarja STD	1 kpl
T4062	RK-laakerisarja STD	1 kpl

08.05.2009

TRAKTORI-MALLI	MOOTTORI-TYYPPI	SYLINTERI-PUTKI	MÄNTÄ STD	RENGAS-SARJA STD	MÄNTÄ 0,020"	RENGAS-SARJA 0,020"
Selectamatic 770	AD3/49A	T4056 K964857		T4053 K261069		T4053A K261070
780, 880	AD3/55A	T4056 K964857	T4049 (a) K949474	T4053 K261069	T4049A (a) K949472	T4053A K261070
Selectamatic 990	449001	T4056 K964857		T4053 K261069		T4053A K261070
1200	A4155A	T4056 K964857	T4049 (a) K949474	T4053 K261069	T4049A (a) K949472	T4053A K261070
Synchromatic 885	355011	T4056 K964857	T4049 (a) K949474	T4053 K261069	T4049A (a) K949472	T4053A K261070
Synchromatic 990	449001	T4056 K964857		T4053 K261069		T4053A K261070
995 996 1210 1212	455051 455071 455009 455031	T4056 K964857	T4049 (a) K949474	T4053 K261069	T4049A (a) K949472	T4053A K261070
1410, 1412	455011	T4056 K964857	T4051 (a) K944573	T4053 K261069	T4051A K946354	T4053A K261070
1190 1194	165004 165004	T4056 K964857	T4049 (a) K949474	T4053 K261069	T4049A (a) K949472	T4053A K261070
1290	2200004	T4056 K964857	T4049 (a, b) K949474	T4053 K261069	T4049A (a, b) K949472	T4053A K261070
1294 1390	220008 2200002	T4056 K964857	T4049 (a) K949474	T4053 K261069	T4049A (a) K949472	T4053A K261070
1394 1490 1494	220103 220101 220105	T4056 K964857	T4051 (a) K944573	T4053 K261069	T4051A K946354	T4053A K261070
1594 1690 1694 1690 Turbo	330002 330001 330102 330101	T4056 K964857	T4051 (a) K944573	T4053 K261069	T4051A K946354	T4053A K261070

a - sisältää männänrenkaat
b - 11052361 →

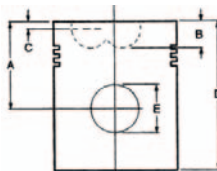
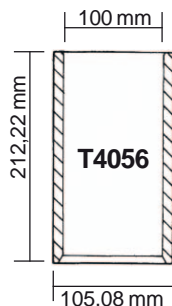

A Männän keskiökorkeus mm
B Palotilan syvyys mm
D Kokonaiskorkeus mm
E Männäntapin halkaisija mm
F Männäntapin pituus mm

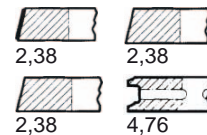

T4053

- sopii: AD3/49, AD4/49,
AD3/55, AD4/55, AD4/55T,
AD6/55, AD6/55T
- 100 mm

TUOTE- NUMERO	NIMIKE	MOOTTORI- TYYPPI	Ø mm	KPL	TERÄS- VAHVIST.	A mm	B mm	C mm	D mm	E mm
T4049 K949474	mäntä	AD3/55, AD4/55	100	4		60,30	20,20	5,50	105,50	31,75
T4051 K944573	mäntä	AD5/55T, AD6/55T	100	4	kyllä	60,30	20,20	5,50	105,60	31,75

28.02.2006



TRAKTORI-MALLI	MOOTTORI-TYYPPI	KIERTOKANGEN LAAKERISARJA			KIERTO-KANGEN HELA
		STD	0.010"	0.020"	
Selectamatic 880	AD3/55A	T4060 K207436	T4060A K207497		T4064 K31669
990 1200	449001 A4155A	T4041 K207436	T4041A K207497	T4041B K207498	T4064 K31669
Synchro 885	355011	T4060 K207436	T4060A K207497		T4064 K31669
995 996 1210 1212	455051 455071 455009 455031	T4041 K207436	T4041A K207497	T4041B K207498	T4064 K31669
1410, 1412	455011	T4173 K929148			T4064 K31669
1190, 1194	165004	T4060 K207436	T4060A K207497		T4064 K31669
1290 1294 1390 1394	2200004 220008 2200002 220103	T4041 K207436	T4041A K207497	T4041B K207498	T4064 K31669
1490 1494	220101 220105	T4173 K929148			T4064 K31669
1594 1690 1694 1690 Turbo	330002 330001 330102 330101	2 x T4060 K207436	2 x T4060A K207497		T4064 K31669



T4041



T4062



T4175

TRAKTORI-MALLI	MOOTTORI-TYYPPI	ISKU mm	Ø mm kk	Ø mm rk	KIERTO-KANGEN LAAKERI-SARJA	RUNKO-LAAKERI-SARJA	PÄITÄIS-LAAKERI-SARJA
990 vm. -68→ kuivaputkikone	AD4-49	101.6	60.27	63.47	T4041 K207436	T4062 K928541	T4175 K928543 + K928542
995, 996, 1200, 1210, 1212, 1290 -83→, 1294, 1390, 1394	AD4-55	114.3	60.27	63.47	T4041 K207436	T4062 K928541	T4175 K928543 + K928542
1410, 1412, 1490, 1494		114.3	63.45	66.65	T4173 K929148	T4174 K928997	

D1.04

26.09.2011



T4062



T4175



T0016



T4188

TRAKTORI- MALLI	MOOTTORI- TYYPPI	RUNKOLAAKERISARJA		PÄITTÄIS- LAAKERI- SARJA STD	KAMPI- AKSELIN ETU- STEFA	KAMPI- AKSELIN TAKA- STEFA
		STD	0.010"			
Selectamatic 880	AD3/55A	T4063 K928540	T4063A K928557	T4175 K928543+ K928542	T0016 K628127	T4188 K921611
990 990 1200	449001 AD4/47 A4155A	T4062 K928541	T4062A K928554	T4175 K928543+ K928542	T0016 K628127	T4188 K921611
Syncromatic 885	355011	T4063 K928540	T4063A K928557	T4175 K928543+ K928542	T0016 K628127	T4188 K921611
Synchromatic 990 995 996 1210 1212	449001 455051 455071 455009 455031	T4062 K928541	T4062A K928554	T4175 K928543+ K928542	T0016 K628127	T4188 K921611
1410 1412	455011 455011	T4174 K928997			T0016 K628127	T4189 K262784
1190 1194	165004 165004	T4063 K928540	T4063A K928557	T4175 K928543+ K928542	T0016 K628127	T4188 K921611
1290 1294 1390	2200004 220008 2200002	T4062 K928541	T4062A K928554	T4175 K928543+ K928542	T0016 K628127	T4188 K921611
1394	220103	T4062 K928541	T4062A K928554	T4175 K928543+ K928542	T0016 K628127	T4188 K921611
1490 1494	220101 220105	T4174 K928997			T0016 K628127	T4189 K262784
1594 1690 1694 1690 Turbo	330002 330001 330102 330101	T4194 K917637+ K917639			T0016 K628127	T4190 K306765

02.03.2007



MF0312

TRAKTORI-MALLI	MOOTTORI-TYYPPI	IMU-VENTTIILI	PAKO-VENTTIILI	LUKKO-PALA (pari)
Selectamatic 780 880	355011 AD3/55A	T4165 K928622	T4165 K928622	MF0312 K943439
Selectamatic 990 1200	449001 A4155A	T4165 K928622	T4165 K928622	MF0312 K943439
Syncromatic 885 Syncromatic 990 995 996 1210 1212 1410 1412	355011 449001 455051 455071 455009 455031 455011 455011	T4165 K928622 T4165 K928622	T4165 K928622 T4165 K928622	MF0312 K943439 MF0312 K943439
1190 1194	165004 165004	T4165 K928622	T4165 K928622	MF0312 K943439
1290 1294 1390	2200004 220008 2200002	T4165 K928622	T4165 K928622	MF0312 K943439
1394 1490 1494	220103 220101 220105	T4165 K928622	T4196 K950100	MF0312 K943439
1594	330002	T4165 K928622	T4196 K950100	MF0312 K943439
1690	330001	T4165 K928622	T4165 K928622	MF0312 K943439
1690 Turbo 1694	330101 330102	T4165 K928622	T4196 K950100	MF0312 K943439

TRAKTORI-MALLI	IMUVENTTIILI STD
990 vm 61-68	T4165

12.01.2009

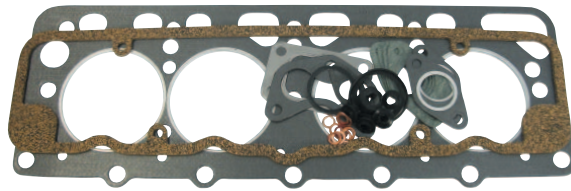

T4074

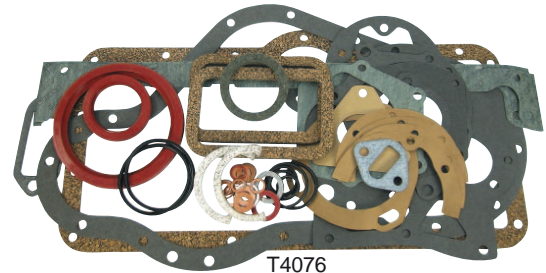

T4076

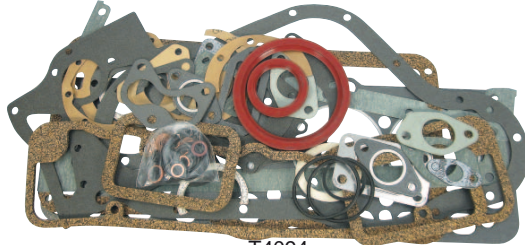

T4094



T4208

TRAKTORI-MALLI	MOOTTORI-TYYPPI	YLÄ-TIIVISTE-SARJA	KANNEN-TIIVISTE	ALA-TIIVISTE-SARJA	VENTTIILI-KANNEN-TIIVISTE	TÄYD. TIIVISTE-SARJA
Selectamatic 880	AD3/55A	T4072 K262754	T4078 K956672	T4075 (c, d) K262764	T4209 K907338	
990 1200	449001 A4155A	T4074 K961001	T4079 K262750	T4076 K260282	T4208 K905229	T4094 K964883+K965803
Syncromatic 885	355011	T4072 K262754	T4078 K956672	T4075 (c, d) K262764	T4209 K907338	
990 995 996 1210 1212 1410, 1412	449001 455051 455071 455009 455031 455011	T4074 K961001	T4079 K262750	T4076 K260282	T4208 K905229	T4094 K964883+K965803
1190 1194	165004 165004		T4078 K956672	T4075 (c, d) K262764	T4209 K907338	
1290 1294 1390 1394 1490 1494	2200004 220008 2200002 220103 220101 220105	T4074 K961001	T4079 K262750	T4076 K260282	T4208 K905229	T4094 K964883+K965803
1594 1690 1694 1690 Turbo	330002 330001 330102 330101	T4191 K965964	T4193 K952527	T4192 K965963		

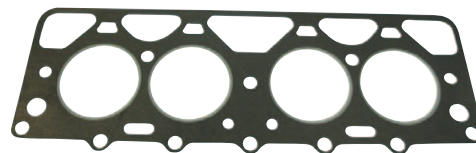

T0012



T0016

VANHAT MALLIT

TRAKTORI-MALLI	YLÄ-TIIVISTE-SARJA	ALA-TIIVISTE-SARJA	KANSI-TIIVISTE	KAMPI-AKSELIN ETUSTEFAA
30, 880 4-syl., 900, 950		T4088 (a)	T0012	
990 vm. -61-68	T0013 K961001	T0014 (c, d) K262765	T0015 K262750	T0016 K628127
		T4089 (a)		

- a - täydellinen tiivistesarja, ei sisällä venttiilivarren kumia
c - sarja ei sisällä kampiakselin etustefaa
d - sarja ei sisällä kampiakselin takastefaa

D1.07

KUVIA SEURAAVAN SIVUN TAULUKKON

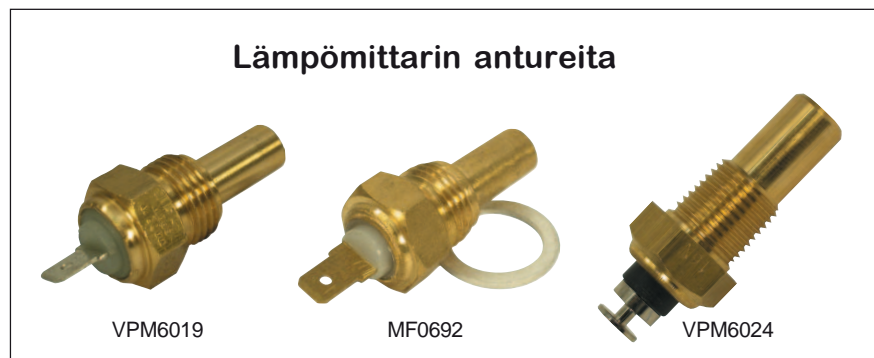
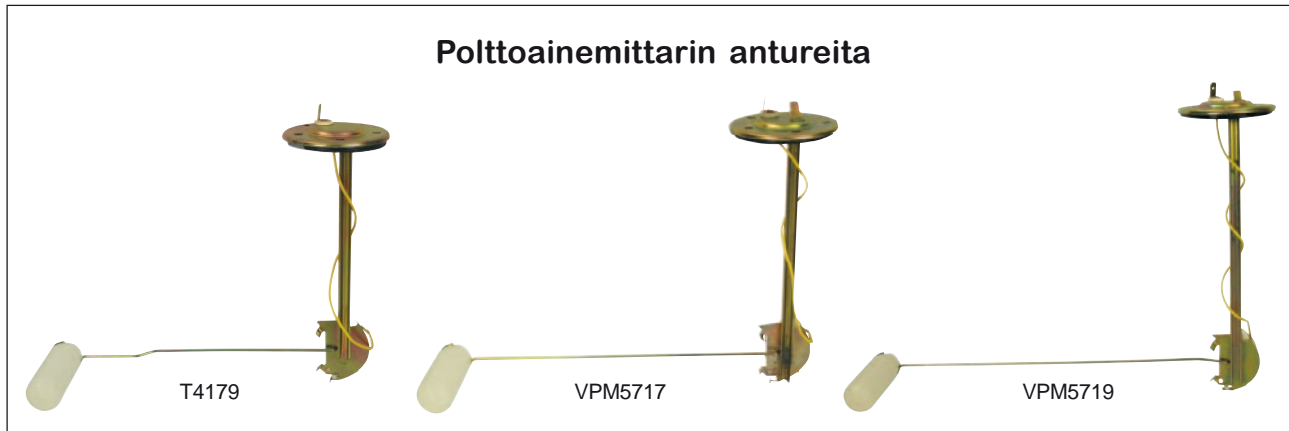

21.09.2009

Huom.

Katso muut kuvat sivulta D1.08



TRAKTORI-MALLI	POLTTO-AINE-MITTARIN ANTURI	ÖLJY-KELLO	HYDRAULI-PAINE-KELLO	JARRU-VALO-KATKAISIN	LÄMPÖ-MITTARIN ANTURI	TUNTI-MITTARIN VAJERI
Selectamatic 770		VPM6001 K311686	VPM6006 K921317		MF0692 K952332	
780, 880, 990, 1200		VPM6001 K311686	VPM6006 K921317		MF0692 K952332	T4178 (m) K311487
Synchromatic 885		VPM6001 K311686	VPM6006 K921317	VPM6013 K929737	MF0692 (l) K952332	VPM5232 (m) K948533
990, 995, 996	T4179 (a) K946158	VPM6001 K311686	VPM6006 K921317	VPM6013 K929737	MF0692 (e) K952332	VPM5232 (m) K948533 VPM5233 (b, p) K954957
1210, 1212		VPM6001 K311686	VPM6006 (d) K921317	VPM6013 (d) K929737	MF0692 (d) K952332	VPM5232 (m) K948533
1410, 1412		VPM6001 K311686	VPM6006 K921317	VPM6013 K929737	MF0692 K952332	VPM5234 (b,q) K954959
1190	VPM5717 (b) K309297	VPM6001 K311686	VPM6006 K921317	VPM6013 (c) K929737		VPM5233 (b,p) K954957
1194	VPM5717 K309297	VPM6001 K311686	VPM6006 K921317	VPM6013 K929737	VPM6024 K311943	VPM5232 (m) K957487
1290	VPM5717 (b) K309297	VPM6001 K311686	VPM6006 K921317	VPM6013 K929737		VPM5233 (b,f,p) K954957 VPM5239 (b,g,r) K957379
1294, 1394	VPM5717 (b) K309297	VPM6001 K311686	VPM6006 K921317	VPM6013 K929737	VPM6024 (b) K311943	VPM5239 (b,r) K957379
1390	VPM5717 (b) K309297	VPM6001 K311686	VPM6006 K921317	VPM6013 K929737		VPM5233 (b,p) K954957 VPM5239 (b,r) K957379
1490	VPM5719 (b) K309299	VPM6001 K311686		VPM6013 (c) K929737	VPM6024 K311943	VPM5233 (b,p) K954957 VPM5239 (b,r) K957379
1494	VPM5719 (b) K309299	VPM6001 K311686		VPM6013 (h) K929737	VPM6024 K311943	VPM5239 (b,r) K957379
1594	VPM5719 (b) K309299	VPM6001 K311686		VPM6013 (j) K929737	VPM6024 K311943	VPM5234 (b,q) K954979
1690, 1690 turbo	VPM5719 (b) K309299	VPM6001 K311686			VPM6024 K311943	VPM5234 (b,q) K954959

a - kiinnitys yläpuolelta
b - hytillä
c - ilman hyttiä
d - →1150001
e - 11070001→
f - →11053998

g - 11053998→
h - 11519051→
j - 11526319→
k - →11070001
l - →1000001

m - kuoren pit. 1235 mm, päät 5/8" / 3/4"
o - kuoren pit. 1260 mm, päät 5/8" / 7/8"
p - kuoren pit. 1400 mm, päät 5/8" / 7/8"
q - kuoren pit. 1590 mm, päät 5/8" / 7/8"
r - kuoren pit. 1400 mm, päät 5/8" / laippa

26.09.2011

Huom.

Tarkista korjaussarja ja pumppu seuraavan sivun kuvista



VPE2600



T2041



V153

TRAKTORI-MALLI	MOOTTORI-TYYPPI	VESI-PUMPPU (a)	VESI-PUMPUN KORJAUS-SARJA (a)	VESI-PUMPUN VESI-PYÖRÄ	TERMOSTAATTI	MOOTTORIN VESI-HANA
770, 780, 880, 885, 990, 770 A/B Sel, 880 A/B Sel, 885 vanhempi	165004, 35501, 355011, 165004, AD349/A, AD355/A, AD447	T4248 K911964	T4033 K961770		T4032 K200831	V153 K622060
990 1200	449001 A4/55A	T4182 K262749 T4250 K201750	T4035 K964489		T4032 K200831	V153 K622060
990	AD4/47	T4182 K262749	T4034 K961004		T4032 K200831	V153 K622060
990	449001	T4182 K262749 T4250 K201750	T4035 K964489 T4036 K965848	VPE2600 K200687	T4032 K200831	V153 K622060
995 996 1210 1212 1410, 1412	455051 455071 455009 455031 455031	T4182 K262749	T4035 K964489 T4036 K965848	VPE2600 K200687	T4032 K200831	V153 K622060
1190	165004	T4247 K200807	T4038 K965888		T2041 K208039	V153 K622060
1194	165004	T4247 K200807	T4038 K965888		T2041 K208039	V153 K622060
1290 1390	2200004 2200002	T4250 K201750	T4038 K965888	VPE2600 K200687	T2041 K208039	V153 K622060
1294, 1394	220008	T4102 K200679	T4038 K965888	VPE2600 K200687	T2041 K208039	V153 K622060
1490	220101	T4249 K201815 T4250 K201750	T4038 K965888	VPE2600 K200687	T2041 K208039	V153 K622060
1494	220105	T4102 K200679 T4246 K207578	T4038 K965888	VPE2600 K200687	T2041 K208039	V153 K622060
1594 1690 Turbo 1694	330002 330101 330102	T4245 K200759	T4038 K965888		T2041 K208039	V153 K622060

VPE2600 - halkaisija 76 mm, reikä 16 mm, korkeus 23 mm

T4182 - vesipyörä pumpun rungon sisäpuolella

T4102 - vesipyörä pumpun rungon ulkopuolella

a - katso mallit sivulta D1.11

26.09.2011

A-mitta = siivapyörän korkeus

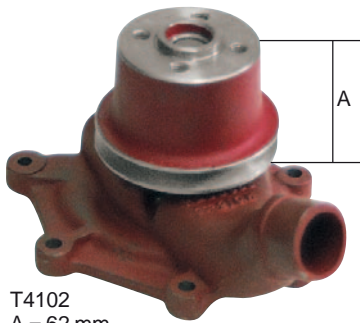

T4102
A = 62 mm



T4182
A = 62 mm

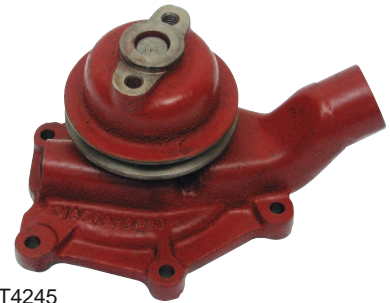

T4245
A = 57 mm

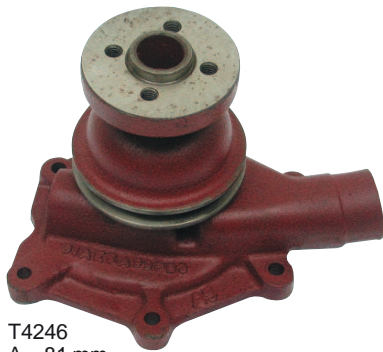

T4246
A = 81 mm

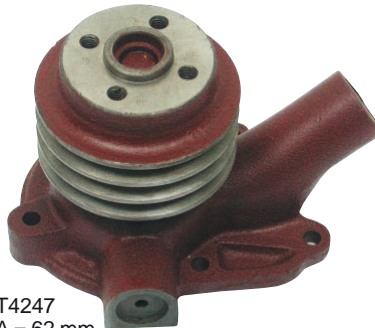

T4247
A = 62 mm

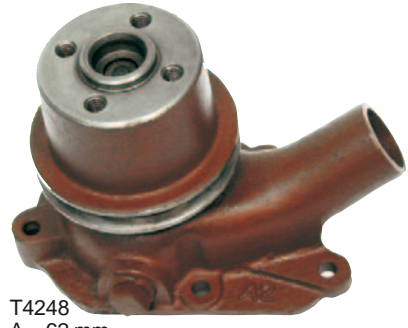

T4248
A = 62 mm



T4249
A = 81 mm



T4250
A = 62 mm

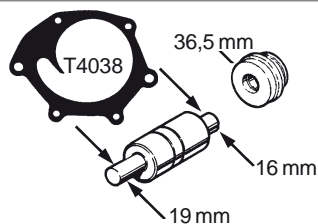
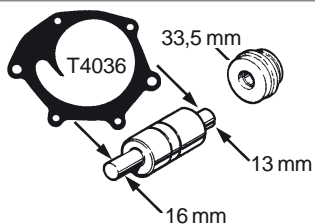
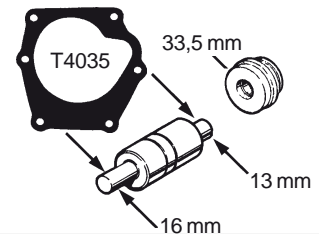
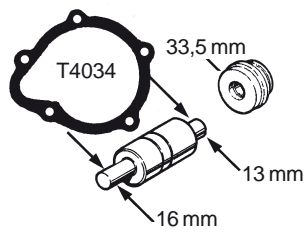
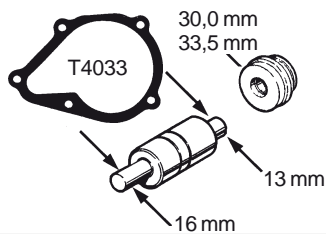

25.07.2008

Katso tuulettimen hihnojen
vertailutaulukko
Tarvikeluettelon sivulta T6.16c.



T4029



F0256



T4013



T4020

V153

TRAKTORI- MALLI	TUULETTIMEN HIHNA	JÄÄHDYTTIMEN KORKKI	YLÄVESI- LETKU	ALAVESI- LETKU	JÄÄHDYTTIMEN VESIHANA
Selectamatic 770 880, 780	T4023 K912196	T4030 (c) K906195 T4031 K945363	T4013 K37575	T4019 (l) K912039 T4018 (k) K915206	V153 K622060
Selectamatic 990	AVX10-1175 K68073	T4031 K945363	T4014 K921972	T4020 K926603	V153 K622060
1200	AVX10-1175 K68073	T4030 (g) K906195	T4014 (m) K921972	T4020 K926603	V153 K622060
Syncromatic 885	T4023 (a) K912196 T4027 K942053	T4031 (d) K945363 F0256 (e) K902092	T4013 K37575	T4018 K915206	V153
Syncromatic 990	T4023 (a) K912196 T4029 K903050	T4031 (d) K945363 F0256 (e) K902092	T4014 K921972	T4020 K926603	V153 K622060
995, 996	AVX10-1175 (a) K68073 T4029 K903050	T4031 (d) K945363 F0256 (e) K902092	T4014 K921972	T4021 K948453	V153 K622060
1210, 1212	AVX10-1175 (a) K68073 T4029 K903050	T4031 (d) K945363 F0256 (e) K902092	T4014 K921972	T4021 K948453	V153 K622060
1410, 1412	AVX10-1175 K68073	T4031 (d) K945363 F0256 (e) K902092	T4015 K946849		V153 K622060
1190, 1194	T4023 K912196	F0256 (e) K902092	T4013 K37575		V153 K622060
1290, 1390 1294, 1394	AVX10-1175 K68073	F0256 (e) K902092	T4016 K37575	T4025 K201976	V153 K622060
1490, 1494	AVX10-1175 K68073	F0256 (e) K902092	T4017 K201747		V153 K622060
1590, 1594, 1690, 1690 turbo, 1694	VPE6084 K311714	F0256 (e) K902092	VPE4133 K201718		V153 K622060

a - tasavirtalaturilla
c - →S550031
d - 4 lbs/in
e - 7 lbs/in

g - →S705364
k - S550032→neliveto malli
l - →S550031
m - S705365→

15.06.2007



7 hyvää syytä vaihtaa uudet suutinkärjet:

1. säästää polttoainetta
2. pidempi moottorin käyttöikä
3. puhtaammat päästöt
4. lisää tehoa
5. enemmän vääntöä
6. parempi käynnistyvyys
7. tasaisempi käynti

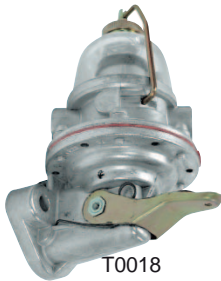
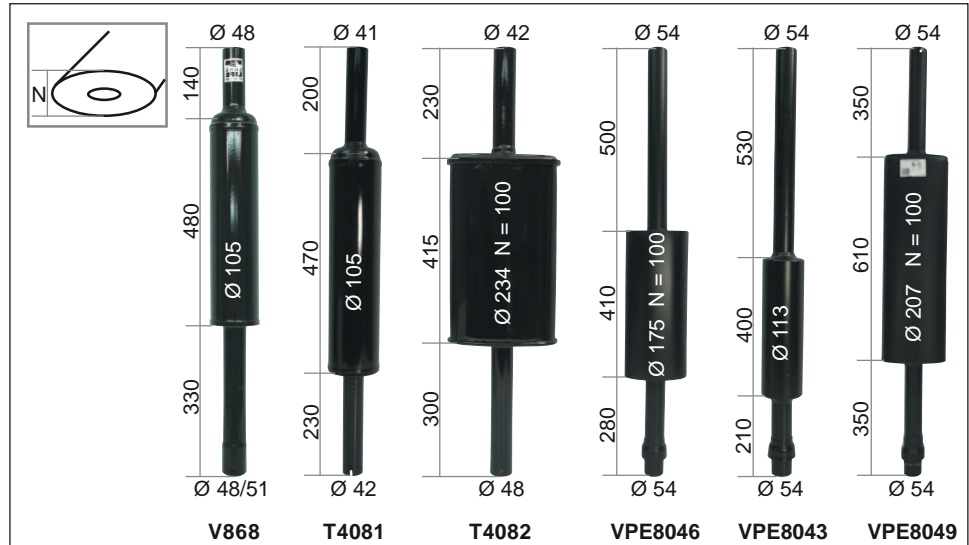

T0018



SD70119



T0402



T0400



MF0441



MF0392

TRAKTORI-MALLI	SIIRTO-PUMPPU	SUUTTIMEN KÄRKI	SUUTTIMEN ALUSLEVY	YLIVUOTO-PUTKEN ALUSLEVY	HEHKU-TULPPA	PAKO-PUTKI	POLTTOAINE-TANKIN KORKKI
30, 880 4-syl., 900, 950		SD70119 BDLL140S6592	T0402	T0400		V868 K914137	
880 3-syl., 885	T4080 K908819	SD70119 BDLL140S6592	T0402	T0400	MF0441 K928523	V868 K914137	MF0392 K304590
990	T0018 K944997	SD70119 BDLL140S6592	T0402	T0400	MF0441 K928523	T4081 K917634	MF0392 K304590
995, 996, 1200	T0018 K944997	SD70119 BDLL140S6592	T0402	T0400	MF0441 K928523	T4082 K928712	MF0392 K304590
1210, 1212	T0018 K944997	SD70119 BDLL140S6592 SD70067 BDLL140S6417	T0402	T0400	MF0441 K928523	T4082 K928712	MF0392 K304590
1190	T4080 K908819	SD70119 BDLL140S6592	T0402	T0400	MF0441 K928523	T4082 K928712	MF0392 K304590
1290, 1390, 1294, 1690	T0018 K944997	SD70119 BDLL140S6592	T0402	T0400	MF0441 K928523	VPE8046 K302952	MF0392 K304590
1410, 1412	T0018 K944997	SD70119 BDLL140S6592 SD70067 BDLL140S6417	T0402	T0400	MF0441 K928523		MF0392 K304590
1394, 1490, 1494, 1694, 1690 Turbo	T0018 K944997	SD70067 BDLL140S6417	T0402	T0400	MF0441 K928523	VPE8043 K306484	MF0392 K304590
1594, 1690	T0018 K944997	SD70067 BDLL140S6417	T0402	T0400	MF0441 K928523	VPE8049 K304708	MF0392 K304590

SAMMUTINVAIJERI

VLD1534

K9331K

- pituus 2,1 m



MOOTTORIN ÖLJYNTÄYTTÖKORKKI

VPC4504

K948427

- 885, 990, 995, 996, 1190, 1194, 1200, 1210, 1212, 1290, 1294, 1390, 1394, 1410, 1412, 1490, 1494, 1594, 1690, 1694



D1.13

25.07.2008

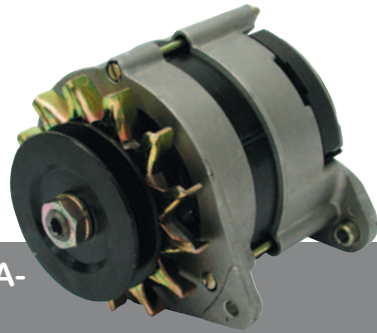

VAIHTOVIRTALATURI 70A

ST0215

K302424

- sisältää tuulettimen ja siivan
- 1194, 1294, 1394, 1494, 1594, 1694
- w-liittimellä

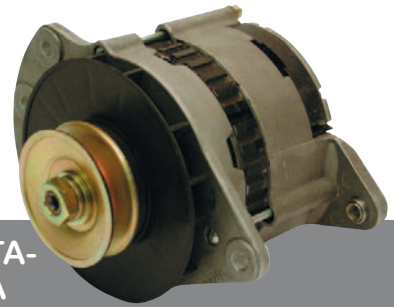

VAIHTOVIRTALATURI 65A

ST0210

3218544R91

- yleismalli, sisältää tuulettimen ja siivan
- soveltuu useimpien 12 V järjestelmien 28-65 A tehoisten latureiden tilalle
- w-liittimellä



ST0001

LUCAS TASA-VIRTALATURI

ST0001

K908882
- 22A

ST0003

K908882
- 11A, suljettu

ST0002

K928643
- 22A



LUCAS ACR 18 VAIHTOVIRTALATURI 45A

ST0005

835339303

- teho 630W
- jännitteen säädin ST0005-10

PIKKULUCAS TASAVIRTALATURI VARAOSAT

HIILI-SARJA



ST0013
USB104

VETO-PÄÄTY



ST0012

VETOPÄÄN LAAKERI

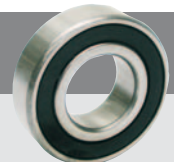

L6302-2RS
UTB107

HIILIPÄÄN PUSLA



ST0016
UTB110

SIIVAPYÖRÄ



ST0009
31141425

RELE

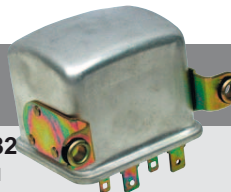

ST0082
K908901

RELE



ST0084
K900136

LUCAS 18 ACR VAIHTOVIRTALATURI 45A VARAOSAT



HIILISARJA

ST0024
836115425



SÄÄDIN

ST0020
836115797

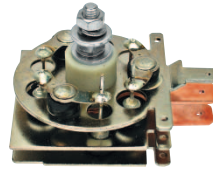

DIODISILTA

ST0021
836115798



SIIVAPYÖRÄ

ST0022 (a)
ST0022B (b)



LIITIN-SARJA

ST0025

a - halkaisija 63 mm, ura 9,5 mm

b - halkaisija 90 mm, ura 12,5 mm

D1.14

04.03.2011

Huom.

Starttimoottorin varaosien sopivuus alkuperäisiin varmistettava



TRAKTORI-MALLI	STARTTI-MOOTTORI	SOLENOIDI	KENTTÄ-KÄÄMI	HIILI-SARJA	HELASARJA	VIRTA-LUKKO	HEHKU-TULPPA
880-3, 885, 1190, 1194, Lucas M45G	ST0151 K957341	ST1067 K963825	ST0045 A48238	ST0047 K964218		ST0087 K203992	
850, 880-4, 950, 990, 996 Lucas M45G	ST0038 K262746	ST0052 K963825	ST0045 A48238	ST0047 K964218	ST0049 K963791		MF0441 (b) K928523
990, 995, 996, 1200, 1210, 1212, 1394, Lucas M127	ST0035A (oik.)(c) K957340 ST0034A (vas.) K957341	ST0054 K964215	ST0046A (a) K262024	ST0048 K962799	ST0051 K963791	ST0087 K203992	MF0441 (b) K928523
1290, 1390, 1410, 1412, 1490, 1494, 1594, 1690, 1694, Lucas M127	ST0035A (oik.) K957340 ST0034A (vas.) K957341	ST0054 K964215	ST0046A (a) K262024	ST0048 K962799	ST0051 K963791	ST0087 K203992	MF0441 (b) K928523
90, 94, 900, 990, 995, 996, 1200, 1210, 1290, 1390, 1400, 1410, 1412, 1490, 1494, 1594, 1690, 1694 LRS212, LRS115 Lucas M50G	ST35220 (oik.) K957340						

a - ST0046A kahdella johdolla

b - lattaliittimellä, ruuviliittimellä V565, kierre UNF718"-14

c - vaihtoehto ST0038 (M45G)

VALOKATKAISIN/ ÄÄNITORVI

T0241

K300657

- 1190, 1194, 1290, 1294, 1390, 1394, 1490, 1594, 1690, 1690 turbo, 1694



04.03.2011

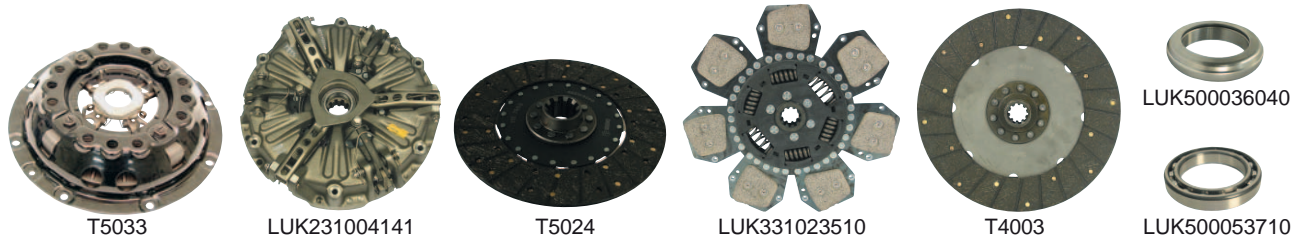

TRAKTORI-MALLI	KYTKIMEN KOKO	KYTKIN-ASETELMA	AJO-KYTKIN-LEVY	V.O.-KYTKIN-LEVY	AJO-PAINELAAKERI	V.O.-PAINELAAKERI
25, 30, 850, 880, 900, 950	10" yksöisk.		T4083 (a) K14014			
880, 885, 900, 950	10"/10" kaksoisk.		LUK325007750 T4084 (b) K89321	T4085 (c) K89322	LUK500036040 K620153	
950,990	11" yksöisk.	T5033 (3) K957252	T0019 (a) K957254			
990, 995	11" parikytkin	LUK128004550 (g, 3) K957252	LUK328009456 T5024 (h) K957254	LUK328024210 T4092 (c) K915827 LUK325007650 T4085 (f) K89322	LUK500036040	
996, 1200, 1210, 1212, 1290, 1294, 1390	11"/11" kaksoisk.	LUK228008710 (1) K957435	LUK328024310 K957254	LUK328024210 T4092 (c) K915827	LUK500036040	LUK500053710 K19177
1190, 1194	12"/12" kaksoisk.	LUK231004141 (1) K202291	T4002 K202625	LUK331012146 T4003 K947089	LUK500036040	LUK500053710 K19177
1210, 1294, 1394, 1410, 1412, 1490, 1494	12"/12" kaksoisk.	LUK231004141 (1) K202291 LUK231004240 (d,1) K956051	T4002 K202625 LUK330003511 K956052	LUK331012146 T4003 K947089	LUK500036040	LUK500053710 K19177
1594, 1690, 1694	12"/12" kaksoisk.	LUK231004340 (d,1) K202825	LUK330003610 (d) K202826	LUK331012246 T4009 K952378	LUK500036040	LUK500053710 K19177

Keskiöiden mitat: Pooriluku: Ø mm:

a - 10 Z 32
b - 10 Z 45
c - 10 Z 29

d - ajokytkinlevy kera-pintainen
f - vanhemmissa 10 "
g - ei sisällä kytkinlevyä

h - vaatii sovitusta
1 - ajolevy
3 - ei levyä

KESKIÖRASVA

LUK414001410

- erityisesti kytkinkeskiöihin ja -akselihin



VAUHTIPYÖRÄN SILMÄLAAKERI

LUK410002300

K19177

- 7/8" x 2" x 9/16"
- 990, 995, 996, 1190, 1194, 1200, 1210, 1212, 1290, 1294, 1390, 1394, 1410, 1412, 1490, 1494, 1594, 1690, 1694



KYTKINASETELMAN SILMÄLAAKERI

L6009-2RS

K19177

- 45 x 75 x 16 mm
- 990, 995, 1190, 1194, 1210, 1294, 1394, 1410, 1412, 1490, 1494, 1594, 1690, 1694



L6207-2RS

K620153

- 35 x 72 x 17 mm
- 996, 1200, 1210, 1212, 1290, 1294, 1390

25.07.2008



KYTKIMEN PÄÄSYLINTERI JA KORJAUSSARJA

- 885, 990, 995, 996, 1190, 1194, 1200, 1210, 1212, 1290, 1294, 1390, 1394, 1400, 1410, 1412, 1490, 1494, 1594, 1690, 1694

Pääsylinteri
T4157
K950544

Korjaussarja
T4158
K964572

KYTKIMEN TYÖSYLINTERIN KORJAUSSARJAT

Korjaussarja
VPJ7242

K964576
- 990, 995, 996, 1200,
1400, 1412, 1490

Korjaussarja
VPJ7241

K261633
- 1394, 1494, 1594, 1690,
1694

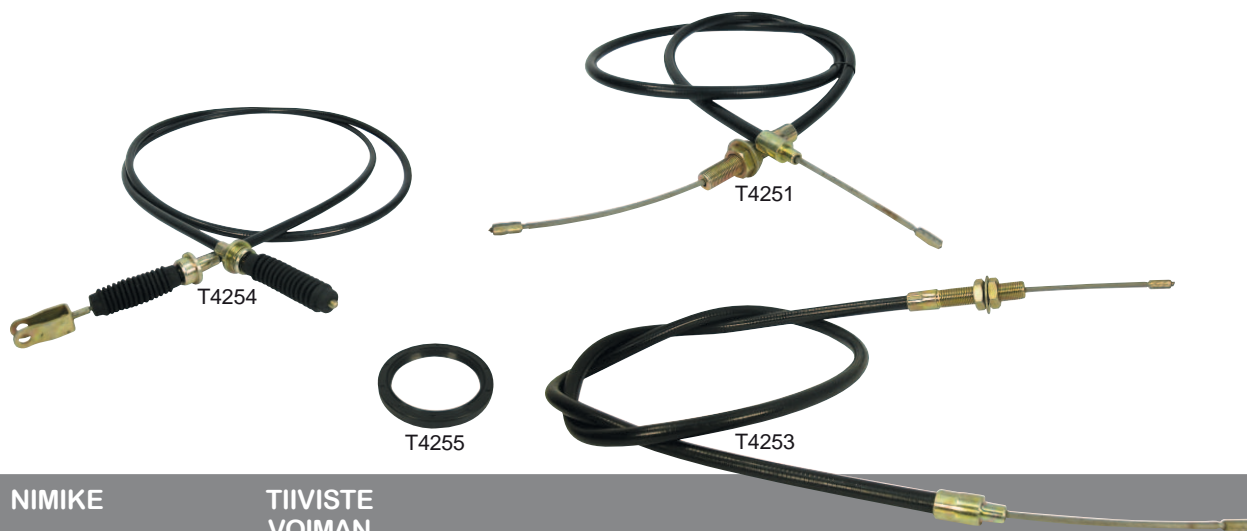

NIMIKE

TIIVISTE
VOIMAN
ULOSOTTO-
AKSELI

VOIMAN ULOSOTON
KYTKIMEN VAIJERI

Tuoteno.

T4255

55 x 70 x 8 mm

T4256

90 x 110 x 13 mm

T4251

K204857

kokonaispituus

1935 mm

T4252

K310598

kokonaispituus

2107 mm

T4253

K204859

kokonaispituus

1810 mm

T4254

K307920

kokonaispituus

2170 mm

Sopivuus

**1210, 1212, 1390,
1394, 1410, 1412,
1490, 1494, 1594,
1690, 1694**

**1190, 1290
1390**

**1194, 1294
1394, 1494**

**1490, 1690
1690 Turbo**

1594, 1694

02.01.2006



TRAKTORI-MALLI	RAIDE-TANGON PÄÄT	SIVU-TANGON PÄÄT (a)	OHJAUS-SYLINTERIN PÄÄ (b)	OHJAUS-SYLINTERIN PÄÄ (c)	ETUPYÖRÄN LAAKERI-SARJA (g)	ETUPYÖRÄN PULTTI	TEHOSTIMEN PUMPUN TIIVISTE-SARJA
Selectamatic 880	V1490 K908071	V1490 K908071			V7199 K962985 V7200 (e) K962986	T4039 K907400	
990	V1490 K908071	V1490 K908071	T4012 K929057	T4010 K207721	V7199 K962985 V7200 (e) K962986	T4039 K907400	
1200	V1490 K908071	T4011 K207722	T4010 K207721	T4010 K207721	V7200 K962986	T4040 K600875	
Syncromatic 885	V1490 K908071	V1490 K908071	T4012 K929057	T4010 K207721	V7199 K962985 VPJ2225 (f) K262214	T4039 K907400	T4087 K964935
990	V1490 K908071	V1490 K908071	T4012 K929057	T4010 K207721	V7199 K962985 V7200 (e) K962986 VPJ2225 (f) K262214	T4039 K907400	T4087 K964935
995, 996	V1490 K908071	V1490 K908071	T4012 K929057	T4010 K207721	V7199 K962985 V7200 (e) K962986 VPJ2225 (f) K262214	T4039 K907400	T4087 K964935
1210	V1490 K908071	T4011 K207722	T4011 (d) K207722 T4012 K929057	T4010 K207721	V7200 K962986	T4040 K600875	T4087 K964935
1212	V1490 K908071	T4011 K207722	T4011 (d) K207722 T4012 K929057	T4010 K207721	V7200 K962986	T4040 K600875	T4087 K964935
1410	T4010 K207721	T4011 K207722	T4011 (d) K207722 T4012 K929057	T4010 K207721	V7200 K962986	T4040 K600875	
1412	T4010 K207721	T4011 K207722	T4011 (d) K207722 T4012 K929057	T4010 K207721	V7200 K962986	T4040 K600875	
1190 1290	V1490 K908071		T4010 K207721	T4010 K207721	V7199 K962985 VPJ2225 (f) K262214	T4039 K907400	T4087 K964935
1390	V1490 K908071		T4010 K207721	T4010 K207721	V7199 K962985 VPJ2225 (f) K262214	T4039 K907400	T4087 K964935
1490	T4010 K207721				V7200 K962986 VPJ2225 (f) K262214	T4040 K600875	T4087 K964935

a - ilman tehostinta
b - etummainen tai ulompi
c - takimmainen tai sisempi
d - poikittaisella ohjaus-sylinterillä

e - vahvistetulla etuakselilla
f - **VPJ2225** sopii uudempiin malleihin, ks. viereinen taulukko

g -

NIMIKE	LAAKERI ULOMPI	LAAKERI SISEMPI
V7199	35 x 65	35 x 65
V7200	38 x 72	44 x 83
VPJ2225	35 x 65	38 x 65

D1.18

05.02.2010

TRAKTORI-MALLI	1	2
1190, 1194, 1210, 1212, 1290, 1294, 1390, 1394, 1410, 1412, 1490, 1690 Hydrostaattisella ohjausjärjestelmällä ja David Brown nelivetoakselilla	T4010 K923766 K207721	V1490 K908071
1494, 1594 Hydrostaattisella ohjausjärjestelmällä ja David Brown nelivetoakselilla		T4011 K915962 K207722

TRAKTORI-MALLI	3	4
1290, 1390, 1490 Carraro nelivetoakselilla	T4225 K965270 M22X1,5RH	T4226 K965269 M22x1,5LH
1294 Carraro nelivetoakselilla	T5136 M20x1,5RH	T5149 M20x1,5LH
1494, 1594, 1690 Carraro nelivetoakselilla	T5145 K260254 M24x1,5RH	T5144 K260250 M24x1,5LH

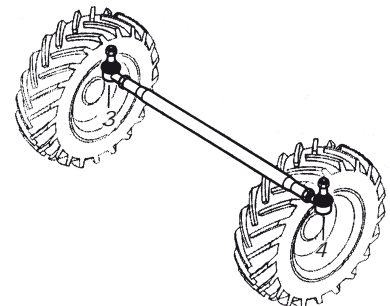
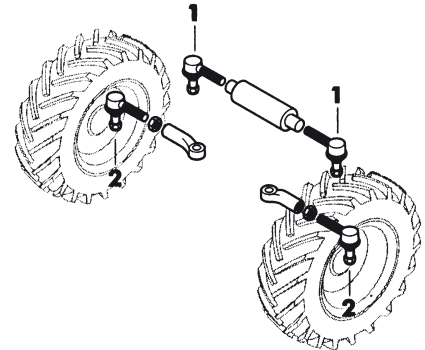

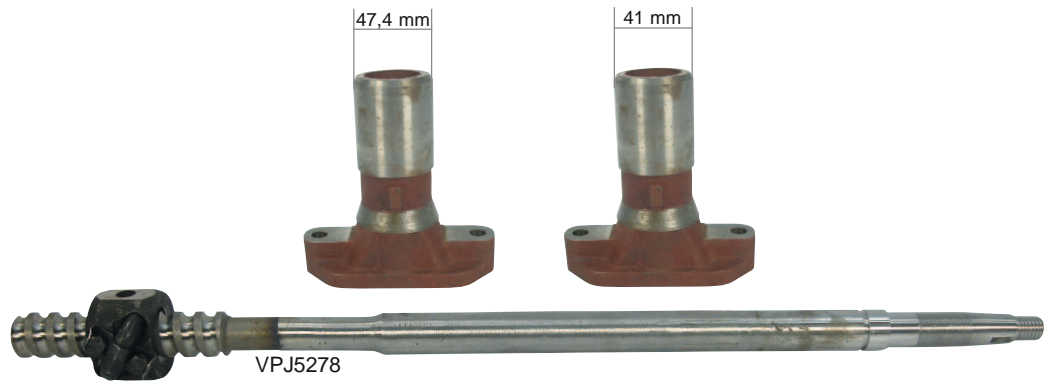

NIMIKE	TUNTIMITTARI	PAKOPUTKEN LÄHTÖ	PAKOPUTKEN LÄHTÖ	SIMPUKAN PYSTYAKSELI
Tuotenumero	T4177 K942227	T4129 K952969	T4130 K928275	VPJ5278 K912411
Sopivuus	880-990	990, 995, 996, 1200, 1210, 1212 47,4 mm Pakoputki tulee sisäpuolelle	990, 995, 996, 1200, 1210, 1212 41,0 mm Pakoputki tulee ulkopuolelle	880, 990 995, 996 L = 622 mm ei tehostin-malli

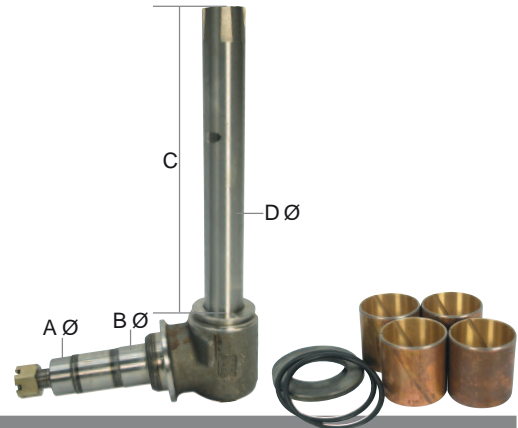

NIMIKE	OHJAUS-TEHOSTIMEN PUMPPU	OHJAUS-TEHOSTIMEN PUMPPU	OHJAUS-TEHOSTIMEN PUMPUN TIIVISTE-SARJA	OLKA-AKSELIT mitat mm A=35, B=38, C=254, D=35	OLKA-AKSELIN KORJAUS-SARJA
Tuotenumero	T4135 K957318	T4135 K957318	T4087 K964935	T4138 (c) K262209	T4222
Sopivuus	990, 995, 996, 1210, 1212	1290, 1390 1410, 1412, 1490	885-1694	880, 885, 990, 995, 996, 1190, 1290, 1390, 1490	880, 885, 990, 995, 996, 1190, 1194, 1290, 1294, 1390, 1394

c -vahvistettu malli, heikompi malli (mitta B 35 mm) korvataan tällä olka-akselilla + VPJ2225 laakerisarja

NAPA-AKSELIN TIIVISTEET

- 770, 780, 850, 880, 885, 950, 990, 995, 996,
1190, 1194, 1200, 1210, 1212, 1290, 1294,
1390, 1394, 1490, 1494

OAS9011012

K623452
- 90x110x12

T4264

K15550
- 82,55x107,95x15,87

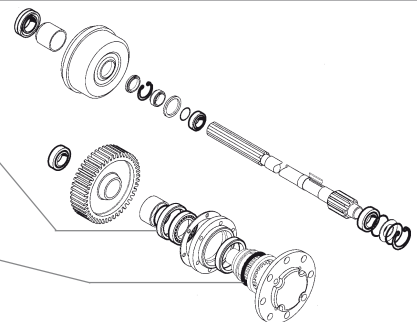

22.10.2010



TRAKTORI-MALLI	JARRU-HIHNA-SARJA	JARRU-PÄÄ-SYLINTERI	JARRUPÄÄ-SYLINTERIN KORJAUS-SARJA	JARRUNTYÖ-SYLINTERIN KORJAUS-SARJA	JARRU-AKSELIN TIIVISTE
30, 900, 950	T0020 (a) K960595				
850	T0020 (a) K960595			VPJ7239 K965723	T4267 (b) K13353
880	T0020 (a) K960595				T4267 (b) K13353
885, 990	T0020 (a) K960595	T4157 K950544	T4158 K964572	VPJ7238 K964573	T4267 (b) K13353
990, 995, 996	T4163 (a) K962266	T4157 K950544	T4158 K964572	VPJ7238 K964573	T4267 (b) K13353
1200, 1210, 1212	T4180 (a) K964542	T4157 K950544	T4158 K964572	VPJ7240 K965765	T4267 (b) K13353
1390, 1490	T4180 (a) K964542	T4157 K950544	T4158 K964572	VPJ7238 K964573	T4267 (b) K13353
1190, 1194, 1290, 1390	T4163 (a) K962266	T4157 K950544	T4158 K964572	VPJ7239 K965723	OAS558010 K262777
1410, 1412, 1494,		T4157 K950544	T4158 K964572	VPJ7239 K965723	T4267 (b) K13353
1494, 1594, 1690, 1694		T4157 K950544	T4158 K964572	VPJ7240 K965765	T4267 (b) K13353

a - hihnan leveys: **T0020** = 44 mm, **T4163** = 63 mm, **T4180** = 89 mm

b - 18,94 x 43,25 x 81,21 mm

MÄRÄT JARRUT

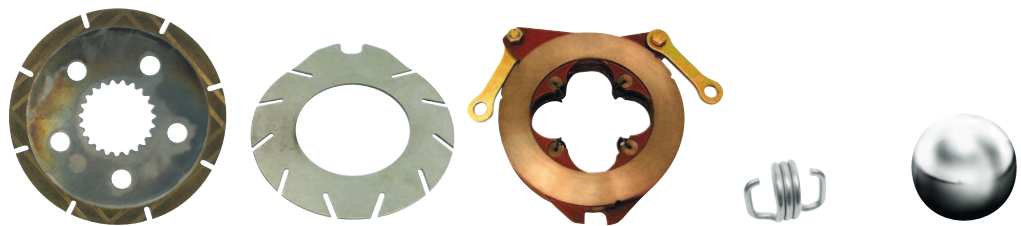

TRAKTORIMALLI	JARRULEVY	VÄLILEVY	TÄYD. PAISUTIN	JOUSI	PALLO
1410, 1412, 1494, 1594 1690, 1694, Ø 222 m	T4228 K945754	V922 K945755	MF0617 K945753	MF0616 K963644	MF0615 K963645



KÄSIJARRUVAIJERI

- ohjaamalla 885, 990, 995, 996, 1190, 1194, 1210, 1212, 1290, 1294, 1390, 1394
- ilman ohjaamoja 1490, 1494, 1594, 1694

Vasen

T4259

K311168

- pituus 1125 mm (kuvassa)

Oikea

T4260

K311167

- pituus 1420 mm

D1.21

NOSTOSYLINTERIN TIIVISTEET

- 990, 995, 996, 1200, 1210, 1212, 1290, 1294, 1390, 1394, 1490, 1494

3" MÄNTÄ:

(vanhoissa malleissa)

O-rengas

692-7

K623567



Tuki-rengas

692-8



3,5" MÄNTÄ:

O-rengas

T4263

238-6338



Tukirengas

T4262

K623567



NOSTOLAITEVENTTIILIN TIIVISTESARJA



T4261

K964568

- 780, 880 530001-, 885, 990, 995, 996, 1190, 1194, 1200, 1210 11154968-, 1212 11154968-, 1290, 1294, 1390, 1394, 1410, 1412, 1490, 1494, 1594, 1690, 1694



Ø 22,5 mm
16,0 puslalla

min. 420mm
isku 150 mm

50 mm
Ø 22,5 mm
haarukan väli 28 mm

SÄÄTÖKAMPI

T4215

K940508

- 800, 900, 1200 sarjat

PUSLA

T0776

- 25,4 / 19,0 mm

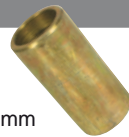

HYDRAULINEN SÄÄTÖKAMPI

T1701

- 800, 900, 1200 sarjat

- mäntä 63 mm

- varsi 35 mm

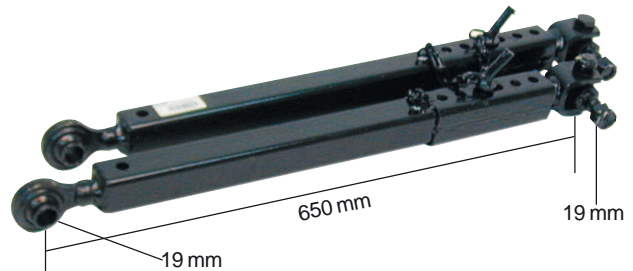
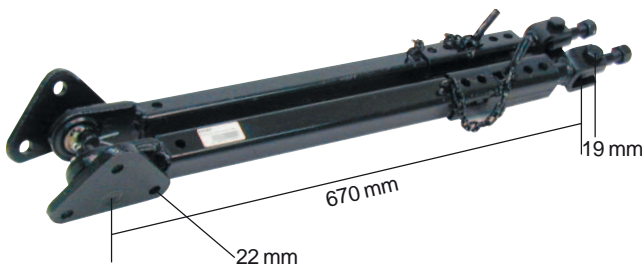

SIVURAJOITINPARI

T0170

- DB990, 995, 996, 1210-1490

- sisäosa 30x30

- sokkatappi 12 mm

SIVURAJOITINPARI

T0169

- DB30, 850, 880, 885, 900, 950

- sisäosa 30x30

- sokkatappi 12 mm

25.07.2008



HYDRAULIPUMPPU

T4113

K962635

- peräkoteloon
- sopii: 770, 780, 880, 885, 990, 995, 996, 1190, 1194, 1290, 1294, 1390
- ei vanhoihin punaisiin malleihin



HYDRAULIPUMPPU

T4118

K310386

- kaksoispumppu nokalle
- 19 cm³ + 14 cm³
- sopii: 1594, 1690, 1690 turbo, 1694



HYDRAULIPUMPPU

T3112

K919048

- yksöispumppu nokalle
- 11 cm³
- sopii: 1200, 1210, 1212



HYDRAULIPUMPPU

T3446

K307945

- yksöispumppu nokalle
- 16 cm³
- sopii: 1390, 1394, 1410, 1412, 1490, 1494



HYDRAULIPUMPPU

T3448

K949605

- yksöispumppu nokalle
- 19 cm³
- sopii: 1594, 1690, 1690 turbo, 1694

HYDRAULIPUMPUN KÄYTTÖAKSELI JA OSAT

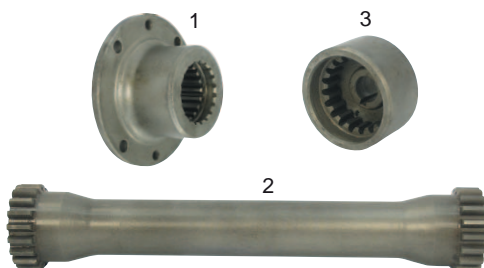

TRAKTORI-MALLI	1. LAIPPA moottorin-puoleinen	2. AKSELI	3. HOLKKI pumpun-puoleinen
1200	T4166 K910538 Ø 112 mm		
1210, 1212, 1294, 1394, 1410, 1412, 1490, 1494	T4166 K910538 Ø 112 mm	T4169 K944950 L = 235 mm	T4171 K944947 L = 46 mm
1594, 1690, 1690, 1694	T4167 K200465 Ø 107 mm	T4170 K200464 L = 120 mm	T4171 K944947 L = 46 mm

D1.23

08.01.2007

OHJAAMON KAASUSYLINTERIT



TRAKTORI-MALLI	OHJAAMON TYYPI	TAKALASIN KAASUSYLINTERI	KATTOLUUKUN KAASUSYLINTERI	OVEN KAASUSYLINTERI
1190, 1290 (- 11053380), 1390 (- 11125866), 1490, 1690 (- 236860)	Sekura	KS0118 K303743	T4185 KS0115 K303741	T4186 KS0116 K302896
1194, 1290 (11053380), 1390 (1125866 -), 1394, 1490 (236860 -), 1494, 1690 (236860 -), 1694	Sekura uudempi malli	KS0118 K303743	T4185 KS0115 K303741	T4187 KS0117 K303870 VPM1678 KS0141 K311288 L = 247 mm KS0141 K311288 L = 269 mm

LASINPYYHKIJÄN SULAT



TRAKTORIMALLI	TUULILASIN SULKA
David Brown Q ohjaamo 885, 990, 995, 996, 1210, 1212, 1410, 1412	VLC3225 K773406 460 mm
Q ohjaamo 990Q, 995Q, 996Q	VLC3225 K773406 460 mm
1190, 1194, 1290, 1294, 1390, 1394, 1490, 1494, 1590, 1594, 1690, 1690 turbo, 1694	VLC3228 K262711 510 mm

TUULILASILIIMASARJA

HK269

- annostellaan kylmänä, valumaton
- max. kiinnitymisaika 25 min
- ajovalmuisaika 2 h
- sisältö: puhdistusaine 20 ml, puhdistusliina, primer 10 ml, primer-levitin, liima 310 ml



D1.24

Sekura-ohjaamo

990, 995, 996, 1210, 1212, 1410, 1412

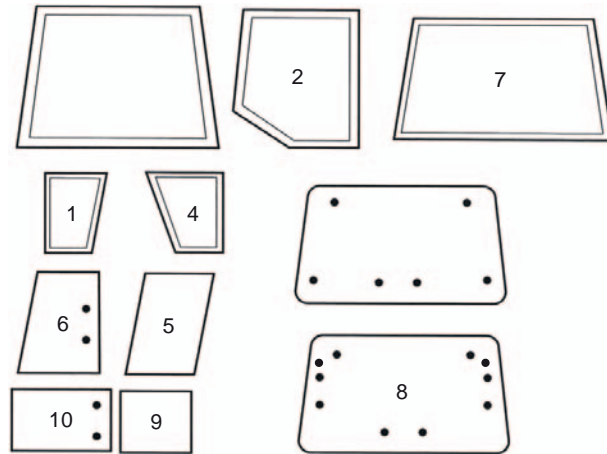

TUOTE-NRO	LASI	KUVAUS	ALKUPERÄIS-NUMERO	KOKO mm (k ork. x lev. x vahv.)	VÄRI	KIINNITYS
1	T20051	Alempi etu	oik., kehyksellä	K965470	630 x 280	kirkas K
1	T20052	Alempi etu	vas., kehyksellä	K965469	630 x 280	kirkas K
2	T20053	Ylempi oven	oik., kehyksellä	K965484	800 x 740	kirkas K
4	T20055	Alempi oven	vas., kehyksellä	K965485	635 x 490	kirkas K
4	T20056	Alempi oven	oik., kehyksellä	3125460R1	635 x 490	kirkas K
5	T20057	Sivulasi	kiinteä, ei avattava		675 x 460 x 5	kirkas K
6	T20058	Sivulasi	liuku, 2 reikää		670 x 385 x 5	kirkas K
7	T20059	Ylempi taka	kehyksellä	K965468	1150 x 675	kirkas K
8	T4213 (a)	Ylempi taka	10 reikää	K965668	1175 x 637 x 5	kirkas R/PK
9	T20060	Alempi taka	kiinteä, ei avattava		478 x 335 x 5	kirkas K
10	T20061	Alempi taka	liuku, 2 reikää		478 x 330 x 5	kirkas K

a - sopii super deluxe -ohjaamoon

Case/IH Deluxe -ohjaamo 90/94-sarja

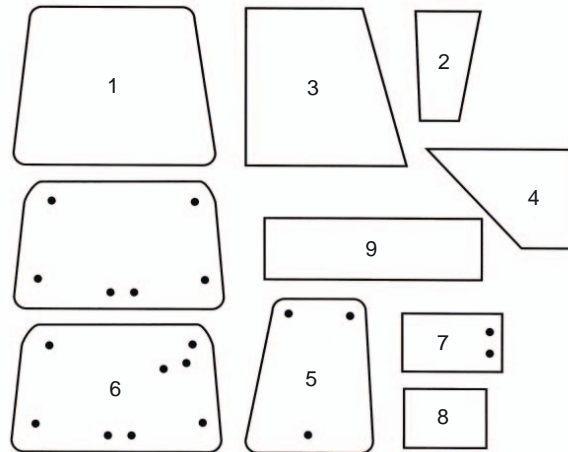
 1190, 1194, 1290, 1294, 1390, 1394,
1490, 1494, 1590, 1594, 1690, 1694

TUOTE-NRO	LASI	KUVAUS	ALKUPERÄIS-NUMERO	KOKO mm (k ork. x lev. x vahv.)	VÄRI	KIINNITYS
1	T4219 (b)	Tuulilasi	kaareva	K262895	1230 x 755 x 5	sävytetty T
2	T20062	Alempi etu	oik., kaareva	K262897	548 x 298 x 5	sävytetty T
3	T20064	Ylempi oven	oik., kaareva	K303700	810 x 665 x 5	sävytetty T
3	T20065	Ylempi oven	vas., kaareva	K303701	810 x 665 x 5	sävytetty T
4	T20066 (c)	Alempi oven	oik., kaareva	K262938	800 x 590 x 5	sävytetty T
4	T20067	Alempi oven	vas., kaareva	K303703	800 x 590 x 5	sävytetty T
5	T20068 (a)	Sivulasi	oik., 3 reikää, kaareva	K303704	630 x 570 x 5	sävytetty R/PK
5	T20069 (a)	Sivulasi	vas., 3 reikää, kaareva	K303705	630 x 570 x 5	sävytetty R/PK
6	T4212	Ylempi taka	8 reikää	K312000	1220 x 685 x 5	sävytetty R/PK
7	T20070	Alempi taka	liuku, 2 reikää	K303707	437 x 325 x 5	sävytetty K
8	T20071	Alempi taka	kiinteä, ei avattava	K303706	437 x 330 x 5	sävytetty K
9	T20072	Alempi taka	yksiosainen	K303950	832 x 329 x 5	sävytetty T

a - sopii vain Case/IH

b - korvaa numeron K303699

c - korvaa numeron K303702

Kiinnitystavat: L = liimattu

PK = pulttikiinnitys

K = kehyksellä

T = tiivisteellä

R = reunasuojalla

D1.25

21.09.2009



ETU-UMPIO

T2360

1333291C1
- 90 ja 94 sarjat



ÄÄRIVALO / TAKAVALO

MF0663

ET420
- vanhat mallit
- varalasi punainen **MF0664**
- varalasi valkoinen **MF0665**
- kumitiiviste **MF0666**



ETULYHTY

ST0099

K921083
- 1200, 1210, 1212, 1410, 1412,
770, 780, 880, 885, 990, 995, 996

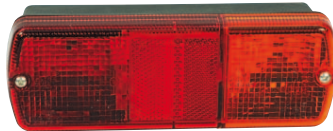

TAKAVALO

T20108

K304886
- sopii 1190, 1194, 1290, 1294, 1390,
1394, 1490, 1494, 1594, 1690, 1694



TAKARAJAVALO

Vasen

T4242
K300190
- varalasi **F0526**

Oikea

T4243
K300189
- varalasi **F0526**



LÄMMITYSLAITTEEN MOOTTORI

ST0145

- vanhemmissa ohjaamoissa



LÄMMITYSLAITTEEN MOOTTORI

- sekura-ohjaamo

T4161

- pituus 195 mm

T4214

1974779C1
- pituus 260 mm



OVEN KAHVA

VLD1443

K260004
- LP-ohjaamo

VLD1445

K773205
- Weatherframe
- ohjaamo
- reikäväli 36 mm

VLD1447

K955435
- Q-ohjaamo



OVEN KAHVA

VLD1429

K303755
- De Lux -ohjaamo



OVEN SISÄKAHVA

- De Lux -ohjaamo

Vasen

VLD1436
K303806

Oikea

VLD1438
K303805

D1.26

26.09.2011



TF4062



MPCAV296



TF5173

TRAKTORI-MALLI	MOOTTORI-ÖLJYN-SUODATIN	POLTO-AINE-SUODATIN	ILMAN-SUODATIN ULOMPI	ILMAN-SUODATIN SISEMPI	HYDRAULIIKKA SUODATIN	OHJAUS-TEHOSTIMEN SUODATIN
770, 780, 850, 880, 885, 900, 950	TF5034 K902125	TF7015 (a) K68859 TF7004 (b) K62594 MPCAV296 DFP556245 K960911	TF2002		TF5175 tai K914441 TF5108 (d) K920522	TF5173 (c) K964954 TF5056 (f) K960750
990, 995, 996 vm. -79 asti	TF5034 K902125	TF7004 (b) K62594 MPCAV296 DFP556245 K960911	TF2002		TF5175 (e) K914441	TF5173 (c) K964954 TF5056 (f) K960750
990, 995, 996 vm. -79 eteenpäin	TF4062 DFP551300 K902125	MPCAV296 DFP556245 K960911			TF5175 (e) K914441	TF5173 (c) K964954 TF5056 (f) K960750
1200, 1210, 1212, 1410, 1412 vm. -79 asti	TF5034 K902125	MPCAV296 DFP556245 K960911	TF2291 K945043		TF5175 (e) K914441	TF5173 (c) K964954 TF5056 (f) K960750
1210, 1212 vm. -79 eteenpäin	TF4062 DFP551300 K902125	MPCAV296 DFP556245 K960911	TF2291 K945043		TF5175 tai K914441 DFP164172 K210049	TF5173 (c) K964954 TF5056 (f) K960750
1410, 1412	TF4062 DFP551300 K902125	MPCAV296 DFP556245 K960911	TF2291 K945043	TF2291-2 K952344	DFP164172 K210049	TF5173 K964954
1190, 1194, 1290, 1294	TF4062 DFP551300 K902125	MPCAV296 DFP556245 K960911	TF2326 K200379	TF2326-2 K200380	TF5175 (e) K914441	TF5173 K964954
1390, 1690	TF4500 DFP554403 K200037	MPCAV296 DFP556245 K960911	TF2326 K200379	TF2326-2 K200380	DFP164172 K210049	TF5173 K964954
1394, 1490, 1494	TF4062 DFP551300 K902125	MPCAV296 DFP556245 K960911	TF2291 K945043	TF2291-2 K952344	DFP164172 K210049	TF5173 K964954
1594, 1694, 1690 turbo	TF4500 DFP554403 K200037	MPCAV296 DFP556245 K960911			DFP164172 K210049	TF5173 K964954

- a - pituus 87 mm, halkaisija 72 mm, reikä 33 mm, vm -60 asti
b - pituus 70 mm, halkaisija 80 mm, reikä 13,5 / 16 mm, vm -64 asti
c - pituus 33 mm, halkaisija 111 mm, reikä 27 mm
d - pituus 80 mm, halkaisija 72 mm, reikä 33 mm
e - tiiviste suodattimen kanteen **T4257** (K262768)
f - erillinen öljysäiliö

TÄYD. PA-SUODATIN KAKSOISMAALI

F0560

81862754, 81866599, 2656818
- 1190, 1194, 1200, 1210, 1212,
1290, 1294, 1390, 1394, 1410,
1412, 1490, 1494, 1594, 1690,
1690 turbo, 1694, 770, 780, 880,
885, 990, 995, 996

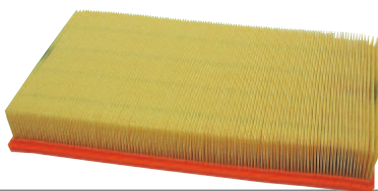

OHJAAMON ILMANSUODATIN

TF2339

- DB SEKURA 90- ja 94-sarjat



SYKLONIN VARALASI

DFP020227

- 1190, 1194, 1290, 1294, 1390, 1394, 1490, 1494, 1690

22.10.2010

KEULAMERKKI

T20117

- 1494, 1594, 1394

