

250, 275, 276

- vertaa männän palotilan kokoa aina vanhaan mäntään

T20078	Mäntä-sylinteriputkisarja	4 kpl
V810	Ylätiivistesarja	1 kpl
V811	Alatiivistesarja	1 kpl
T0001	Kampiaks. etustefa	1 kpl
T2081	Kampiaks. takastefa	1 kpl
T2239	KK-laakerisarja STD	1 kpl
T2239A	KK-laakerisarja 010	1 kpl
T2239B	KK-laakerisarja 020	1 kpl
T2239C	KK-laakerisarja 030	1 kpl
T2240	RK-laakerisarja STD	1 kpl
T2240A	RK-laakerisarja 010	1 kpl
T2240B	RK-laakerisarja 020	1 kpl

414, 434, 444 - BD154

- putken ulkohalkaisija 93,65 mm
- vertaa männän palotilan kokoa aina vanhaan mäntään

T2341	Mäntä-sylinteriputkisarja	4 kpl
V810	Ylätiivistesarja	1 kpl
V811	Alatiivistesarja	1 kpl
T2239	KK-laakerisarja STD	1 kpl
T2239A	KK-laakerisarja 010	1 kpl
T2239B	KK-laakerisarja 020	1 kpl
T2239C	KK-laakerisarja 030	1 kpl
T2240	RK-laakerisarja STD	1 kpl
T2240A	RK-laakerisarja 010	1 kpl
T2240B	RK-laakerisarja 020	1 kpl

454 - BD179

* varustettu korkeapuristeisella männällä,
vaihdta aina kaikkiin sylintereihin

T2001	Mäntä-sylinteriputkisarja	3 kpl
T2422	Mäntä-sylinteriputkisarja*	3 kpl
T2315	Tiivistesarja täydellinen	1 kpl
T2071	Kampiaks. etustefa	1 kpl
T2070	Kampiaks. takastefa	1 kpl
T2011	KK-laakerisarja STD	1 kpl
T2011A	KK-laakerisarja 010	1 kpl
T2015	RK-laakerisarja STD	1 kpl

474, 584, 585, 595, 3230 - D206

- vertaa männän palotilan kokoa aina vanhaan mäntään

T2002	Mäntä-sylinteriputkisarja	4 kpl
T2316	Tiivistesarja täydellinen	1 kpl
T2071	Kampiaks. etustefa	1 kpl
T2070	Kampiaks. takastefa	1 kpl
T2012	KK-laakerisarja STD	1 kpl
T2012A	KK-laakerisarja 010	1 kpl
T2012B	KK-laakerisarja 020	1 kpl
T2016	RK-laakerisarja STD	1 kpl
T2016A	RK-laakerisarja 010	1 kpl
T2016B	RK-laakerisarja 020	1 kpl

574, 674, 684, 685, 695, 4210 - D239

- männäntappi 36 mm
- vertaa männän palotilan kokoa aina vanhaan mäntään

T2001	Mäntä-sylinteriputkisarja	4 kpl
T2316	Tiivistesarja täydellinen	1 kpl
T2071	Kampiaks. etustefa	1 kpl
T2070	Kampiaks. takastefa	1 kpl
T2012	KK-laakerisarja STD	1 kpl
T2012A	KK-laakerisarja 010	1 kpl
T2012B	KK-laakerisarja 020	1 kpl
T2016	RK-laakerisarja STD	1 kpl
T2016A	RK-laakerisarja 010	1 kpl
T2016B	RK-laakerisarja 020	1 kpl

484, 485, 495, 523, 553, 633, 640, 3220-D179

- vertaa männän palotilan kokoa aina vanhaan mäntään

T2229	Mäntä-sylinteriputkisarja	3 kpl
T2315	Tiivistesarja täydellinen	1 kpl
T2071	Kampiaks. etustefa	1 kpl
T2070	Kampiaks. takastefa	1 kpl
T2011	KK-laakerisarja STD	1 kpl
T2011A	KK-laakerisarja 010	1 kpl
T2015	RK-laakerisarja STD	1 kpl

784, 785, 795, 824, 844, 4220, 84 & 85 Hydro - D246

- vertaa männän palotilan kokoa aina vanhaan mäntään

T2230	Mäntä-sylinteriputkisarja	4 kpl
T2316	Tiivistesarja täydellinen	1 kpl
T2071	Kampiaks. etustefa	1 kpl
T2070	Kampiaks. takastefa	1 kpl
T2012	KK-laakerisarja STD	1 kpl
T2012A	KK-laakerisarja 010	1 kpl
T2012B	KK-laakerisarja 020	1 kpl
T2016	RK-laakerisarja STD	1 kpl
T2016A	RK-laakerisarja 010	1 kpl

724, 824, 743, 744, 745 - D239

- vertaa männän palotilan kokoa aina vanhaan mäntään

T2229	Mäntä-sylinteriputkisarja	4 kpl
T2316	Tiivistesarja täydellinen	1 kpl
T2071	Kampiaks. etustefa	1 kpl
T2070	Kampiaks. takastefa	1 kpl
T2012	KK-laakerisarja STD	1 kpl
T2012A	KK-laakerisarja 010	1 kpl
T2012B	KK-laakerisarja 020	1 kpl
T2016	RK-laakerisarja STD	1 kpl
T2016A	RK-laakerisarja 010	1 kpl

453, 533 - D155

- vertaa männän palotilan kokoa aina vanhaan mäntään

T2002	Mäntä-sylinteriputkisarja	3 kpl
T2315	Tiivistesarja täydellinen	1 kpl
T2071	Kampiaks. etustefa	1 kpl
T2070	Kampiaks. takastefa	1 kpl
T2011	KK-laakerisarja STD	1 kpl
T2011A	KK-laakerisarja 010	1 kpl
T2015	RK-laakerisarja STD	1 kpl

844, 845, 885, 884, 895, 4230 - D268

- vertaa männän palotilan kokoa aina vanhaan mäntään

- teräsvahvisteinen mäntä

- tarkista KK-laakereiden mitat:

T2014 = 30 mm, T2012 = 32,1 mm

T2003	Mäntä-sylinteriputkisarja	4 kpl
T2316	Tiivistesarja täydellinen	1 kpl
T2071	Kampiaks. etustefa	1 kpl
T2070	Kampiaks. takastefa	1 kpl
T2014	KK-laakerisarja STD	1 kpl
T2016	RK-laakerisarja STD	1 kpl
T2016A	RK-laakerisarja 010	1 kpl
T2016B	RK-laakerisarja 020	1 kpl

956, 955, 1046, 1055, 1056 - D358

- vertaa männän palotilan kokoa aina vanhaan mäntään

- männäntappi 36 mm

T2229	Mäntä-sylinteriputkisarja	6 kpl
T2317	Tiivistesarja täydellinen	1 kpl
T2071	Kampiaks. etustefa	1 kpl
T2070	Kampiaks. takastefa	1 kpl
T2011	KK-laakerisarja STD	2 kpl
T2011A	KK-laakerisarja 010	2 kpl
T2017	RK-laakerisarja STD	1 kpl



TRAKTORI-MALLI	MOOTTORI-TYYPPI	SYLINTERI-LUKU	SYLINTERIN HALK.
EUROOPASSA VALMISTETUT MALLIT			
D217, D217S, S219	DD.74	2	87,3
D324, D326	DD.111	3	87,3
323	DU.111	3	87,3
D436, DTD5	DD.148	4	87,3
D439	DU.148D	4	87,3
353, 383, 423, 433, 440, 453, 533, 540	D.155	3	98,4
523, 553, 633, 640	D.179	3	98,4
554, 624, 644, 645, 654, 733, 740	D.206	4	98,4
724, 743, 744, 745, 83, 840, 846	D.239	4	98,4
856XL	DT.239	4	98,4
824, 844	D.246	4	100
844S, 845S, 845XL	D.268	4	100
756, 946, 955	D.310	6	98,4
956, 1046, 1055, 1056	D.358	6	98,4
1246, 1255 (+XL)	DT.358	6	98,4
1455 (+XL)	DT.402	6	100
MAXXUM 5120	4T-390	4	102
MAXXUM 5130	6-590	6	102
MAXXUM 5140	6T-590	6	102
MAXXUM 5150	6T-690	6	102
MAGNUM 7110, 7120	6T-830	6	114
MAGNUM 7130	6T-830	6	114
MAGNUM 7140	6TA-830/ 6CTA-830	6	114
MAGNUM 7210, 7220, 7230	6T-830	6	114
MAGNUM 7240	67I-830	6	114
MAGNUM 7250	6TIR-830	6	114

TRAKTORI-MALLI	MOOTTORI-TYYPPI	SYLINTERI-LUKU	SYLINTERIN HALK.
ENGLANNISSA VALMISTETUT MALLIT			
275, 276, 354	BD.144	4	85,7
374, 384, 414, 434, 444	BD.154	4	88,9
385, 395, 3210	D.155	3	98,4
454, 484, 485, 495, 3220	D.179	3	98,4
474, 584, 585, 595, 3230	D.206	4	98,4
475	Perkins A4.212		98,4
574, 674, 684, 685, 695, 4210	D.239	4	98,4
784, 785, 795, 4220	D.246	4	100
884, 885, 895, 4230	D.268	4	100

25.07.2008



Case IH moottorin korjaussarjat STD sisältää:

- mäntä-/putkisarjan
- täydellisen tiivistesarjan
- kampiakselin etu- ja takatiivistein, tarkista sivulta E1.08
- kk-laakerit STD
- rk-laakerit STD

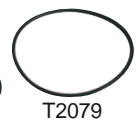

TRAKTORI-MALLI	MOOTTORI-TYYPPI SYLINDERIN HALK. mm	MOOTTORIN KORJAUS- SARJA STD	SYLINDERI- PUTKI- SARJA 1-syl.	MÄNTÄ Huom! Vertaa aina palotilan koko vanhaan mäntään	RENKAAT	PUTKI	PUTKEN O-RENGAS
250, 275, 276	BD144 85,72	K0280	T20078 751603R92 x4	T2222 (a) 751605R92	T2224 (a) 3114775R91	T2220 704092R1	T2080 704100R1
414 (l)	BD154 88,90	K0281		T2223 (a) 3044480R94	T2225 (a) 3114778R91	T2221 3044481R3	T2080 704100R1
414, 434, 444	BD154 88,90	K0281A	T2341 3044479R94	T2223 (a) 3044480R94	T2225 (a) 3114778R91	T2342 3044481R3	T2080 704100R1
454	D179 98,425	K0282	T2001 3139591R96 T2422 (o) 1806470C91		T2233 (j) 3218416R92 T2010 (k) 3139594R1 T2231 (m) 3059262R92	T2007 3139592R4	T2079 3228344R1
474, 584, 585, 595, 3230	D206 98,425	K0283	T2002 3218758R95	T2005 (j) B3364	T2233 (j) 3218416R92 T2010 (k) 3139594R1	T2008 3139587R3	T2079 (c) 3228344R1 T2226 (d) 3228348R1
475	Perkins 4,212 98,48	K0012		V3701X (g) 3118170R91	V3701R (j) 3118131R1	MF0313 796227R1	
574, 674	D239 98,425	K0284	T2001 (s) 3139591R96 T2422 (o) 1806470C91		T2233 (j) 3218416R92 T2010 (k) 3139594R1 T2232 (m) 3059262R92	T2007 3139592R4	T2079 3228344R1
484, 485, 495, 3220	D179 98,425	K0285	T2229 3218759R95 T2422 (o) 3139591R96	T2228 (j) B3363	T2233 (j) 3218416R92 T2010 (k) 3139594R1	T2007 3139592R4	T2079 (c) 3228344R1 T2226 (d) 3228348R1
684, 685, 695, 4210	D239 98,425	K0284	T2229 3218759R95 T2001 (h) 3139591R96 T2422 (o) 1806470C91	T2228 (j) B3363	T2233 (j) 3218416R92 T2010 (h,k) 3139594R1	T2007 3139592R4	T2079 (c) 3228344R1 T2226 (d) 3228348R1
784, 785, 795, 4220, 84- ja 85-hydro	D246 100,00	K0286	T2230 3218668R94		T2234 (j) 3218669R91	T2009 3144682R3	T2079 (c) 3228344R1 T2226 (d) 3228348R1

Katso huomautukset seuraavalta sivulta

E1.02

Alkuperäisnumerot ovat ainoastaan vertailua varten, eivätkä tarkoita, että tuotteet ovat alkuperäisiä.
Taulukoissa esiintyvät kuvat ovat viitteellisiä.



IH MOOTTORIN KORJAUSSARJAT STD, MÄNNÄT, PUTKET JA RENKAAT



26.09.2011

TRAKTORI-MALLI	MOOTTORI-TYYPPI SYLINDERIN HALK. mm	MOOTTORIN KORJAUSSARJA STD	SYLINDERI-PUTKI-SARJA yhteen sylinteriin	MÄNTÄ Huom! Vertaa aina palotilan koko vanhaan mäntään	RENKAAT	PUTKI	PUTKEN O-RENGAS
523, 553, 633, 640	D179 98,425	K0285	T2229 3218759R95 T2422 (o) 1806470C91	T2228 (j) B3363	T2233 (j) 3218416R92 T2232 (m) 3059262R92	T2007 3139592R4	T2079 3228344R1
624	D206 98,425	K0283	T2002 3218758R95	T2005 (j) B3364	T2233 (j) 3218416R92	T2008 3139587R3	T2079 3228344R1
724, 824, 743, 744	D239 98,425	K0287	T2229 3218759R95 T2422 (o) 1806470C91	T2228 (j) B3363	T2233 (j) 3218416R92 T2232 (m) 3059262R92	T2007 3139592R4	T2079 3228344R1
824, 844	D246 100,00	K0286	T2230 3218668R94		T2234 (j) 3218669R91	T2009 3144682R3	T2079 (c) 3228344R1 T2226 (d) 3228348R1
533, 453	D155 98,425	K0288	T2002 3218758R95	T2005 (j) B3364	T2233 (j) 3218416R92	T2008 3139587R3	T2079 (c) 3228344R1 T2226 (d) 3228348R1
745	D239 98,425	K0287	T2229 (s) 3218759R95 T2422 (o, s) 1806470C91	T2228 (j) B3363	T2233 (j) 3218416R92	T2007 3139592R4	T2226 3228348R1
844, 845, 885, 884, 895, 4230	D268 100,00	K0289 (v)	T2003 3218461R95	T2006 (f) B3367	T2235 (k) 3144977R91	T2009 3144682R3	T2226 3228348R1
955	D310 98,425	K0290 (t)	T2002 3218758R95	T2005 (j) B3364	T2233 (j) 3218416R92 T2232 (m) 3059262R92	T2008 3139587R3	T2079 3228344R1
956, 955, 1046, 1055, 1056	D358 98,425	K0291	T2229 (s) 3218759R95 T2422 (o, s) 1806470C91	T2228 (j) B3363	T2233 (j) 3218416R92 T2232 (m) 3059262R92	T2007 3139592R4	T2079 (c) 3228344R1 T2226 (d) 3228348R1
856 Turbo 1246, 1255	DT239 DT358 98,425		T2322 (r) 3144516R97		T2010 (k) 3139594R91	T2007 3139592R4	T2226 (d) 3228348R1
MX3210	D155 98,425		T2002 3218758R95	T2005 (j) B3364	T2233 (j) 3218416R92	T2008 3139587R3	T2226 3228348R1
MX3220	D179 98,425		T2422 (o) 1806470C91			T2007 3139592R4	T2226 (d) 3228348R1
MX3230	D206 98,425		T2002 3218758R95	T2005 (j) B3364	T2233 (j) 3218416R92	T2008 3139587R3	T2226 (d) 3228348R1
MX4210	D239 98,425		T2422 (o) 1806470C91			T2007 3139592R4	T2226 (d) 3228348R1
MX4220	D246 100,00		T2230 3218668R94		T2234 (j) 3218669R91	T2009 3144682R3	T2226 (d) 3228348R1
MX4230	D268 100,00		T2003 3218461R95	T2006 (f) B3367	T2235 (k) 3144977R91	T2009 3144682R3	T2226 (d) 3228348R1
MX4240	DT268 100,00					T2009 3144682R3	T2226 3228348R1

- a - 5 rengasta
c - lisätietoja sivulla E1.06
d - lisätietoja sivulla E1.06
f - teräsvahvisteinen mäntä, 3-rengasuraa, kartio ylärengas
g - ilman renkaita
h - 668611→
j - 3 rengasuraa, suora ylärengas
k - 3 rengasuraa, kartio ylärengas
l - →57678

- m - 4 rengasuraa, kartio ylärengas
n - 4 rengasuraa, suora ylärengas
o - **T2422** (1806470C91) varustettu korkeapuristeisella männällä (vaihda aina kaikkiin sylintereihin)
r - männäntappi 38 mm
s - männäntappi 36 mm
t - D310 moottoria ei Suomessa
v - tarkista kk-laakerien mitat sivulta E1.07

E1.03

Alkuperäisnumerot ovat ainoastaan vertailua varten, eivätkä tarkoita, että tuotteet ovat alkuperäisiä.
Taulukoissa esiintyvät kuvat ovat viitteellisiä.

26.09.2011

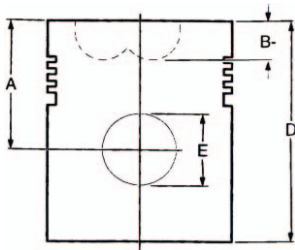
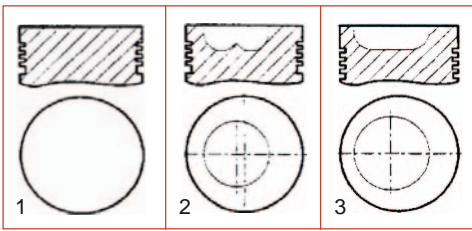

A - männän keskiökorkeus mm
 B - palotilan syvyys mm
 D - kokonaispituus mm
 E - männäntapin halkaisija mm



TUOTE- NUMERO	MOOTTORI- TYYPPI	Ø mm	MALLI	RENGAS- LUKU	TERÄS- VAHVIS- TEINEN	A mm	B mm	D mm	E mm
T2222	BD.144	85,72	1	5		50,95		98,98	28,00
	D.155, D206, D310	98,42	2	3	kyllä	67,00	19,90	107,00	36,00
V3701X	A4.212	98,48	3	3		76,53	19,57	116,13	34,92
T2006	D.268	100,00	2	3	kyllä	67,00	24,00	107,00	36,00



MÄNNÄNRENKAIDEN MITAT JA MALLIT

TUOTE- NUMERO	SYLINTERIN HALKAISIJA					
T2224 3114775R91	85,72 mm					
		2,38 mm	2,38 mm	3,17 mm	4,76 mm	4,76 mm
T2225 3114778R91	88,90 mm					
		2,38 mm	2,38 mm	2,38 mm	4,76 mm	4,76 mm
T2232 (a) 3059262R92	98,42 mm					
		3,00 mm	3,17 mm	3,17 mm	4,76 mm	
T2233 3218416R92	98,42 mm					
		3,17 mm	2,38 mm	4,76 mm		
T2010 (a) 3139594R91	98,42 mm					
		3,00 mm	2,38 mm	4,76 mm		
V3701R 3118131R1	98,48 mm					
		2,38 mm	2,38 mm	4,76 mm		
T2234 3218669R91	100,00 mm					
		3,17 mm	2,38 mm	4,76 mm		
T2235 (a) 3144977R91	100,00 mm					
		3,00 mm	2,38 mm	4,76 mm		

a - kartio ylärengas

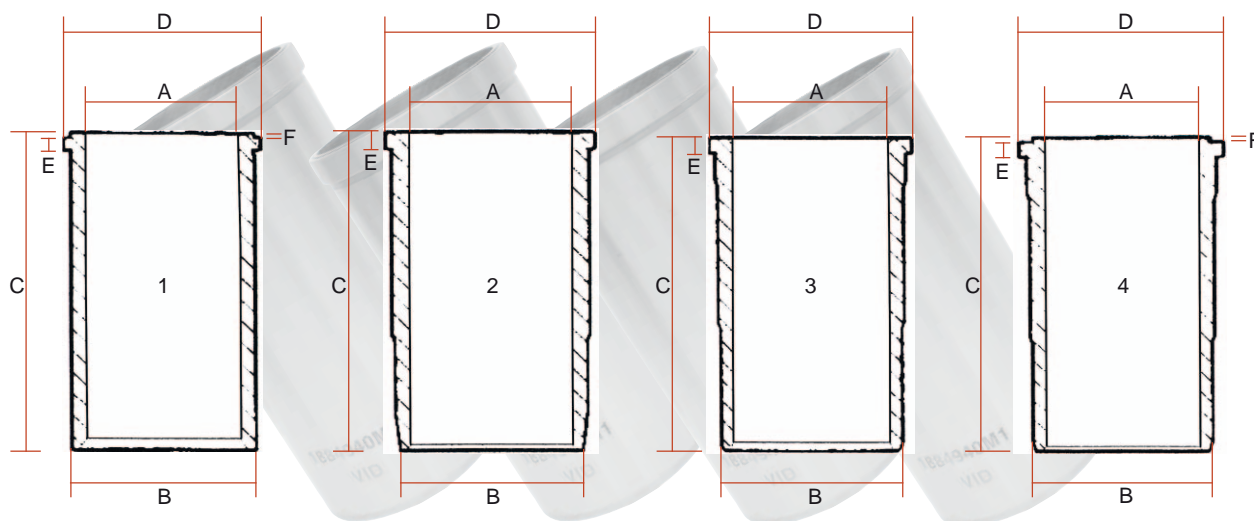

A - nimellishalkaisija mm C - kokonaispituus mm E - laipan vahvuus mm
 B - ulkohalkaisija mm D - laipan halkaisija mm F - laipan ylitys mm

TUOTE- NUMERO	MALLI	A mm	B mm	C mm	D mm	E mm	F mm
T2220	2	85,72	93,64	179,39	101,70	5,82	
T2342	3	88,90	93,65	185,73	101,70	5,82	
MF0313	1	98,48	103,19	227,28	106,45	3,86	0,89
T2008	4	98,42	110,75	201,10	119,00	7,70	1,10
T2007	4	98,42	110,75	216,10	119,00	7,70	1,10
T2009	4	100	110,75	216,10	119,00	7,70	1,10
T2221	2	88,86	96,85	185,98	101,60	5,85	

SYLINDERIPUTKEN O-RENKAAT IH MOOTTOREISSA

D115, D179, D206, D239, D246, D268, DT239, D310, D358, DT358

Asenna ehdottomasti oikeat O-renkaat!

O-renkaan uraa on pienennetty v. 1980

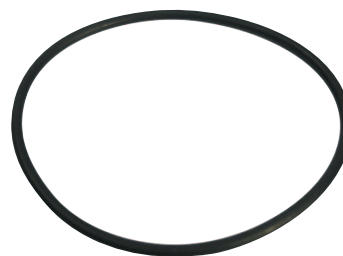

TUOTE- NUMERO	ALKUPERÄIS- NUMERO	ø mm PURISTAMATON	MITTA URAN POHJASTA SYLINDERI- LOHKOSTA mm
T2079	3228344R1	5,0 mm	118,54-118,80
T2226	3228348R1	4,75 mm	118,32-118,58

21.09.2009



T2237



T2012



T2016



T2018

TRAKTORI-MALLI	MOOTTORI-TYYPPI	KIERTOKANGEN LAAKERISARJA STD 010" (a)		RUNKO-LAAKERISARJA STD 010" (a)		KIERTO-KANGEN PUSLA	ÖLJY-PUMPPU
250, 275, 276, 414, 434, 444	BD144 BD154	T2239 3070546R91	T2239A	T2240 708912R91	T2240A	V1135 3043611R1	
454	D179	T2011 3055351R91	T2011A 3056834R11	T2015 3055129R21 x1 + 3055130R21 x3	T2015A 3056820R11 x1 + 3056832R21 x3	T2018 (d) 3132018R2	
474, 574, 674	D206 D239	T2012 (c) 3055351R91 x4	T2012A (c) 3056834R11 x4	T2016 3055129R21 x1 + 3055130R21 x4	T2016A	T2018 (d) 3132018R2	T2237 3136430R95
475 (b)	Perkins 4-212	V388 311813R1	V388A 3118136R1	V387 3118150R1	V387A 3118151R1	V1963 795775R1	V592 41314182
484	D179	T2011 3055351R91	T2011A 3056834R11	T2015 3055129R21 x1 + 3055130R21 x3	T2015A 3056820R11 x1 + 3056832R21 x3	T2018 (d) 3132018R2	
584, 684, 784	D206 D239 D246	T2012 (c) 3055351R91 x4	T2012A (c) 3056834R11 x4	T2016 3055129R21 x1 + 3055130R21 x4	T2016A	T2018 (d) 3132018R2	T2237 3136430R95
585, 595, 3230 685, 4210 785, 795, 4220	D206 D239 D246	T2012 (c) 3055351R91 x4	T2012A (c) 3056834R11 x4	T2016 3055129R21 x1 + 3055130R21 x4	T2016A	T2018 (d) 3132018R2	T2237 3136430R95
523	D179	T2011 3055351R91	T2011A 3056834R11	T2015 3055129R21 x1 + 3055130R21 x3	T2015A 3056820R11 x1 + 3056832R21 x3	T2018 (d) 3132018R2	
624, 724, 744 824, 833	D206 D239	T2012 (c) 3055351R91 x4	T2012A (c) 3056834R11 x4	T2016 3055129R21 x1 + 3055130R21 x4	T2016A	T2018 (d) 3132018R2	T2237 3136430R95
533, 453, 433	D155	T2011 3055351R91	T2011A 3056834R11	T2015 3055129R21 x1 + 3055130R21 x3	T2015A 3056820R11 x1 + 3056832R21 x3	T2018 (d) 3132018R2	
745 824, 844	D236 D246	T2012 (c) 3055351R91 x4	T2012A (c) 3056834R11 x4	T2016 3055129R21 x1 + 3055130R21 x4	T2016A	T2018 (d) 3132018R2	T2237 3136430R95
844, 845, 884, 885, 4230, 4240	D268	T2014 (c) 3144688R92 x4		T2016 3055129R21 x1 + 3055130R21 x4	T2016A	T2018 (d) 3132018R2	T2237 3136430R95
955 1046, 1055	D310 D358	2 x T2011 3055351R91	2 x T2011A 3056834R11	T2017 3055129R21 x1 + 3055130R21 x4	2 x T2016A	T2018 (d) 3132018R2	T2238 3136433R95
856	DT239	T20077 3132101R91		T2016 3055129R21 x1 + 3055130R21 x4	T2016A		
956, 1056	D358	2 x T2011 3055351R91	2 x T2011A 3056834R11	T2017 3055129R21 x1 + 3055130R21 x4	2 x T2016A	T2018 (d) 3132018R2	T2238 3136433R95
CX70, CX80, CX90, CX100 MX80C, MX90C, MX100C							VPD1023 293177A1

a - saatavana myös muita alikokoja
B = 020" ja C = 030"

b - katso muita osia MF-sivuilta

c - huom. T2012 lev. 32,10 mm
T2014 lev. 30,00 mm

d - Ø 36 mm

KAMPIAKSELI

T2418

3144626R92

- D239, 574, 674, 684, 685, 695, 724, 743, 744, 745, 824, 833, 840, 4210

- D246, 784, 785, 795, 824, 844, 4220, 84-Hydro, 85-Hydro

- ei laakereita

- nelisynteriseen

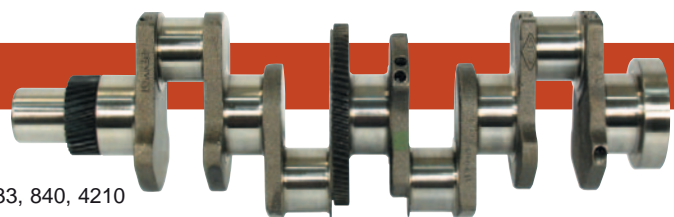

22.10.2010

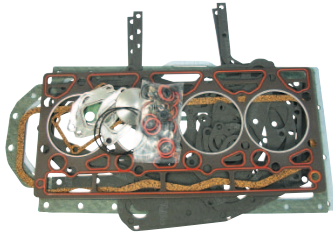

T2316

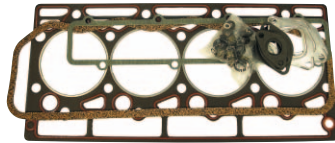

T2025

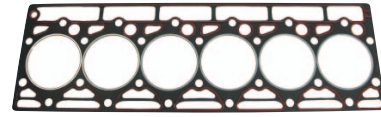

T2030



T2071

TRAKTORI-MALLI	MOOTTORI-TYYPPI	TÄYDELLINEN TIIVISTE-SARJA	YLÄ-TIIVISTE-SARJA	ALA-TIIVISTE-SARJA	KANNEN-TIIVISTE	ETU-STEFA	TAKA-STEFA	VENTTIILI-KANNEN TIIVISTE
250, 275, 276	BD144	T2217 (c)	V810 706105R93	V811 (d,e) 3041249R92	T2216 703883R7	T0001 3108650R91	T2081 3072092R91	VPA4529 3069767R1
414, 434, 444	BD154	T2217 (c)	V810 706105R93	V811 (d,e) 3041249R92	T2216 703883R7	T0001 3108650R91	T2081 3072092R91	VPA4529 3069767R1
454	D179	T2315 (c)	T2022 3136798R99		T2024 3228361R1	T2071 (a) 3228401R91	T2070 3138701R91	VPA4527 3138641R1
474	D206	T2316 (c)	T2025 1967014C1	T2026 (d,e) 1967011C1	T2027 3228362R2	T2071 (a) 3228401R91	T2070 3138701R91	VPA4528 3138642R3
475 (b)	Perkins 4-212		V657 747169M92	V658 747191M91	MF0382 3118173R1	V1198 3118128R91	V397 795662R1	MF0267 3118186R1
574, 674	D239	T2316 (c)	T2025 1967014C1	T2026 (d,e) 1967011C1	T2027 3228362R2	T2071 (a) 3228401R91	T2070 3138701R91	VPA4528 3138642R3
484	D179	T2315 (c)	T2022 3136798R99		T2024 3228361R1	T2071 (a) 3228401R91	T2070 3138701R91	VPA4527 3138641R1
584	D206	T2316 (c)	T2025 1967014C1	T2026 (d,e) 1967011C1	T2027 3228362R2	T2071 (a) 3228401R91	T2070 3138701R91	VPA4528 3138642R3
684	D239	T2316 (c)	T2025 1967014C1	T2026 (d,e) 1967011C1	T2027 3228362R2	T2071 (a) 3228401R91	T2070 3138701R91	VPA4528 3138642R3
784, 884, 885	D246	T2316 (c)	T2025 1967014C1	T2026 (d,e) 1967011C1	T2027 3228362R2	T2071 (a) 3228401R91	T2070 3138701R91	VPA4528 3138642R3
585	D206	T2316 (c)	T2025 1967014C1	T2026 (d,e) 1967011C1	T2027 3228362R2	T2071 (a) 3228401R91	T2070 3138701R91	VPA4528 3138642R3
685, 785	D239	T2316 (c)	T2025 1967014C1	T2026 (d,e) 1967011C1	T2027 3228362R2	T2071 (a) 3228401R91	T2070 3138701R91	VPA4528 3138642R3
523	D179	T2315 (c)	T2022 3136798R99		T2024 3228361R1	T2071 (a) 3228401R91	T2070 3138701R91	VPA4527 3138641R1
624	D206	T2316 (c)	T2025 1967014C1	T2026 (d,e) 1967011C1	T2027 3228362R2	T2071 (a) 3228401R91	T2070 3138701R91	VPA4528 3138642R3
724	D239	T2316 (c)	T2025 1967014C1	T2026 (d,e) 1967011C1	T2027 3228362R2	T2071 (a) 3228401R91	T2070 3138701R91	VPA4528 3138642R3
824, 844	D239 D246	T2316 (c)	T2025 1967014C1	T2026 (d,e) 1967011C1	T2027 3228362R2	T2071 (a) 3228401R91	T2070 3138701R91	VPA4528 3138642R3
533, 453	D155	T2315 (c)	T2022 3136798R99		T2024 3228361R1	T2071 (a) 3228401R91	T2070 3138701R91	VPA4527 3138641R1
745	D239	T2316 (c)	T2025 1967014C1	T2026 (d,e) 1967011C1	T2027 3228362R2	T2071 (a) 3228401R91	T2070 3138701R91	VPA4528 3138642R3
844, 845	D268	T2316 (c)	T2025 1967014C1	T2026 (d,e) 1967011C1	T2027 3228362R2	T2071 (a) 3228401R91	T2070 3138701R91	VPA4528 3138642R3
955, 946	D310	T2317 (c)	T2028 3136801R99	T2029 1967013C1	T2030 3228019R1	T2071 (a) 3228401R91	T2070 3138701R91	VPA4530 3138688R1
1046, 1055	D358	T2317 (c)	T2028 3136801R99	T2029 1967013C1	T2030 3228019R1	T2071 (a) 3228401R91	T2070 3138701R91	VPA4530 3138688R1
856 Turbo	DT239			T2026 (d,e) 1967011C1	T2027 3228362R2	T2071 (a) 3228401R91	T2070 3138701R91	VPA4528 3138642R3
956, 1056	D358	T2317 (c)	T2028 3136801R99	T2029 1967013C1	T2030 3228019R1	T2071 (a) 3228401R91	T2070 3138701R91	VPA4530 3138688R1
1255, 1455	DT358 D402	T2317 (c)	T2028 3136801R99	T2029 1967013C1	T2030 3228019R1	T2071 (a) 3228401R91	T2070 3138701R91	VPA4530 3138688R1
5120, 5120PRO	4T-390							T2453 J930906
5130 5140 5150	6-590 6T-590 6T-690		T2452 (h) A77925		T2450 J283335			
MX100, MX110 MX120, MX135 MX150, MX170			T2452 (h) A77925		T2450 J283335			T2453 J930906
3210, 3220, 3230, 4210, 4220, 4230						T2071 (a) 3228401R91		

a - HUOM! T2071A etustefasarja sisältää myös liukurenkaan
b - katso muita osia myös MF165/A4.212 kohdalla
c - ei sisällä akselitivisteitä eikä sylinteriputken O-renkaita
d - ei sisällä kampiakselin takapään stefaa

e - ei sisällä kampiakselin etupään stefaa
h - ei sisällä kannentivisteitä

08.05.2009



TRAKTORI-MALLI	MOOTTORI-TYYPPI	IMU-VENTTIILI	PAKO-VENTTIILI	JOUSI	OHJURI IMU PAKO	VARREN- TIIVISTE
414, 434, 444	BD154	T2211 3040361R1	T2212 3043825R1		T2213 3044492R1 T2214 3044493R2	
385 454, 485, 633 474 574, 674	D155 D179 D206 D239	T2019 3055055R2	T2020 3055056R2	T2215 3044240R1	T2021 3055022R2	T2082 3218399R91
475	Perkins A4-212	V10024 (a) 795730R1	V10025 (a) 3118132R1	V10028 (b) 3118134R1 V10029 (c) 3118133R1		MF0260 3118179R1
484 584 684 784	D179 D206 D239 D246	T2019 3055055R2	T2020 3055056R2	T2215 3044240R1	T2021 3055022R2	T2082 3218399R91
585 685	D206 D239	T2019 3055055R2	T2020 3055056R2	T2215 3044240R1	T2021 3055022R2	T2082 3218399R91
533, 453, 433 523 624, 644, 645, 733 724, 824 824, 785	D155 D179 D206 D239 D246	T2019 3055055R2	T2020 3055056R2	T2215 3044240R1	T2021 3055022R2	T2082 3218399R91
745, 833, 744 844, 845, 884, 885	D239 D268	T2019 3055055R2	T2020 3055056R2	T2215 3044240R1	T2021 3055022R2	T2082 3218399R91
955, 946 1046, 1055 956, 1056	D310 D358 D358	T2019 3055055R2	T2020 3055056R2	T2215 3044240R1	T2021 3055022R2	T2082 3218399R91
856	DT239		T2020 3055056R2	T2215 3044240R1	T2021 3055022R2	T2082 3218399R91

a - saatavana myös ylikokoja A = 003, B = 015, C = 030

b - sisempi

c - ulompi

SYLINTERIN KANSI

T2399

3044490R91

414, 434, 444

- moottorityyppi BD 154

- sisältää venttiilit ja esikammion

22.10.2010

Katso tuulettimen hihnojen vertailutaulukko Tarvikeluettelon sivulta T6.16c.



T2047

T2046

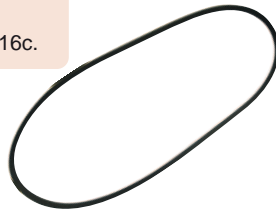

V055



T2061



T2063



T2054



T2059

V457

TRAKTORI-MALLI	JÄÄHDYTTIMEN KORKKI	TUULETTIMEN HIHNA	VÄLILETKKU	VESI-PUMPUN LETKU	YLÄ-VESI-LETKU	ALA-VESI-LETKU	LATURIN HIHNA
275	T2046 3111424R91	V455 709502R1	T2061 3065127R1		T2048 704289R2 T2049 (a) 3065130R1	T2056 3044009R1	V457 704449R1
414	T2046 3111424R91	V455 709502R1			T2050 (d) 3042414R1	T2057 3044009R1	V457 704449R1
414, 276, 434	T2046 3111424R91	V455 709502R1	T2061 3065127R1		T2051 (e) 3065129R1	T2057 3044009R1	V457 704449R1
454	T2047 1500626C92	AVX13-1575 3129139R1		T2062 3132144R1	T2053 402191R1	T2058 402189R1	
385, 484, 485, 485XL	T2047 1500626C92	AVX13-1575 3129139R1 AVX13-1550 (g) 3129140R1		T2063 3144028R1	T2053 402191R1	T2058 402189R1	
374, 384, 444, 354, 434	T2046 3111424R91	V455 709502R1	T2061 3065127R1		T2052 3112067R1	T2057 3044009R1	V457 704449R1
474	T2047 1500626C92	AVX13-1550 3129140R1		T2063 3144028R1	T2054 402207R1	T2059 402205R1	
475	T2047 1500626C92	V055 3055715R1			T2285 3116665R2	T2286 3116664R2	
574, 674	T2047 1500626C92	AVX13-1550 3129140R1		T2062 3132144R1	T2054 402207R1	T2059 402205R1	
644, 645	T2242 3134146R1	V055 3055715R1		T2243 3132719R1	VPE4187 3134507R1	VPE4188 3057428R1	
484	T2047 1500626C92	AVX13-1575 3129139R1		T2063 3144028R1	T2053 402191R1	T2058 402189R1	
584, 684, 784 585, 585XL, 685, 685XL, 785, 785XL, 884, 885, 885XL	T2047 1500626C92	AVX13-1550 3129140R1		T2063 (b) 3144028R1	T2054 (b) 402207R1	T2059 (b) 402205R1	
523, 624		V055 3055715R1			VPE4187 3134507R1	VPE4188 3057428R1	
533, 433, 633	T2242 3134146R1	V055 3055715R1		T2243 3132719R1	T2244 3148117R1	T2245 3216754R1	
745XL, 856, 856XL, 844, 844XL, 845, 845XL	T2242 3134146R1				VPE4187 3134507R1	VPE4188 3057428R1	
946, 1046	T2242 3134146R1	AVX13-1425 3138935R1		T2243 3132719R1		T2245 3216754R1	
955, 955XL, 956, 956XL, 1055, 1055XL, 1056, 1056XL, 1255, 1255XL, 1455, 1455XL	T2242 3134146R1	AVX13-1425 3138935R1			T2055 3220434R1	T2060 3220435R1	

a - saman kokoinen molemmista päistä
b - ilman ilmastointilaitetta

d - sarjanumeroon →32795
e - sarjanumerosta 32795→

g - vain 485XL

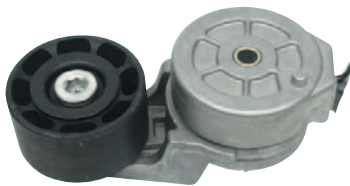

HIHNAKIRISTIN

T2685

J918944, J934817, J936202, J936203
- Maxxum 5120, 5130, 5140, 5150, Magnum 7110, 7120,
7130, 7140, 7210, 7220, 7230, 7240, 7250, MX 100,
110, 120, 135, 150, 170, 180, 200, 220, 240, 270



HIHNAKIRISTIN

F1016

87801838, 87840057
- MXM120, 130, 140, 155, 175, 190

E1.10

Alkuperäisnumerot ovat ainoastaan vertailua varten, eivätkä tarkoita, että tuotteet ovat alkuperäisiä.
Taulukoissa esiintyvät kuvat ovat viitteellisiä.

KORJAUSSARJA

T2045

1094012R91

- sopii: 454, 474, 574, 674, 484, 485, 485XL, 584, 585, 585XL, 684, 685, 685XL, 784, 385, 433, 523, 533, 453, 624, 633, 644, 724, 824, 844, 844XL, 845, 845XL, 745, 745XL, 744, 785, 785XL, 884, 885, 885XL, 895, 895XL, 856, 856XL, 3210, 3220, 3230, 4210, 4220, 4230, 4240

KORJAUSSARJA

V8580A

3118126R91

- sopii: 475



KORJAUSSARJA

T2044

1094021R91

- sopii: 250, 275, 276, 354, 374, 384, 414, 434, 444

KORJAUSSARJA

T2249

3055285R94

- sopii: 946, 1046, 955, 955XL, 1055, 1055XL, 956, 956XL, 1056, 1056XL, 1246, 1255, 1255XL, 1455, 1455XL

TERMOSTAATIT

T2041

K208039

- sopii: 250, 275, 276, 354, 374, 384, 414, 434, 444



T2041

T2043

3118127R1

- sopii: 475

T2042

3228046R1

- sopii: 454, 474, 574, 674, 484, 485, 485XL, 584, 585, 585XL, 684, 685, 685XL, 784, 385, 433, 523, 533, 453, 624, 633, 644, 724, 824, 844, 844XL, 845, 845XL, 745, 745XL, 744, 784, 785, 785XL, 884, 885, 885XL, 895, 895XL, 946, 1046, 955, 955XL, 1055, 1055XL, 856, 856XL, 956, 956XL, 1056, 1056XL, 1246, 1255, 1255XL, 1455, 1455XL, 3210, 3220, 3230, 4210, 4220, 4230, 4240

VPE3405

218039A1

- sopii: CX70, CX80, CX90, CX100, MX80C, MX90C, MX100C

T20110

A77736, J906700, J912587

- sopii: 5120, 5130, 5140, 5150, 5220, 5230, 5240, 5250, 580K, MX100, MX110, MX120, MX135, MX150, MX170

KIRISTYSSIIVA

T2248

- sopii: 250, 275, 276, 354, 374, 384, 414, 434, 444



22.10.2010



V8263

3119778R92

- sopii: 250, 275, 276, 354, 374, 384, 414, 434, 444
- korjaussarja T2044



V8579

3118125R91

- sopii: 475
- korjaussarja V8580A



T2031

3136053R92

- sopii: 454, 474, 574, 674, 484, 485, 485XL, 584, 585, 585XL, 684, 685, 685XL, 784, 785, 785XL, 884, 885, 885XL, 895, 895XL, 3210, 3220, 3230, 4210, 4220, 4230, 4240
- korjaussarja T2045

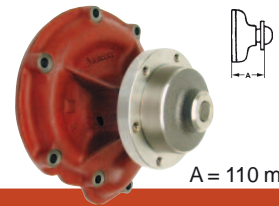

T2416

3136217R92

- sopii: 385, 433, 523, 533, 453, 624, 633, 644, 724, 743, 743XL, 744, 745, 745XL, 824, 844, 844XL, 845, 845XL, 856, 856XL
- korjaussarja T2045

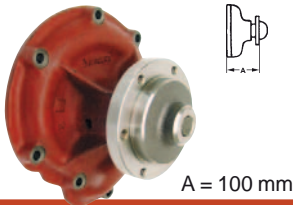

T2247

3138936R92

- sopii: 946, 955, 955XL, 956, 956XL, 1046, 1055, 1055XL, 1056, 1056XL, 1246, 1255, 1255XL, 1455, 1455XL
- korjaussarja T2249

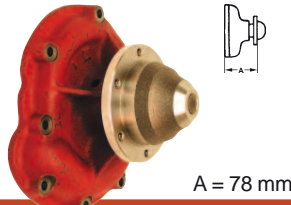

T2032

3132676R93

- sopii: 946, 955, 955XL, 956, 956XL, 1046, 1055, 1055XL, 1056, 1056XL, 1246, 1255, 1255XL, 1455, 1455XL
- akseli 16 mm
- koneisiin, joissa kompressori
- korjaussarja T2249

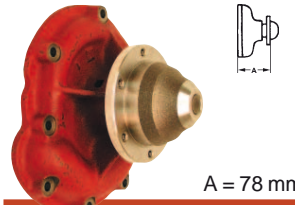

T2417

3144661R93

- sopii: 956, 956XL, 1056, 1056XL, 1246, 1255, 1255XL, 1455, 1455XL
- akseli 24 mm
- korjaussarja T2249



T2396

A77703, J802358

- sopii: MAXXUM 5120, 5130, 5140, 5150, MX100, MX110, MX120, MX135, MX150, MX170
- moottoryypit: B4.390, B6.590, BT6.590, BTA6.590

Huom!
Tarkista mitat!

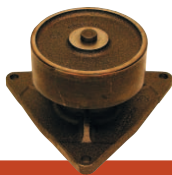

T2398

A77704, J802479

- sopii: MAGNUM 7110, 7120, 7130, 7140
- moottoryypit: CT6.830, CTA6.830



F0664

87802496

- MXM135, MXM150, MXM165, MXM180
- vesipyörän halk. 126 mm

Huom!
Tarkista mitat!



F0665

87801641

- MXM120, MXM130, MXM140, MXM155, MXM175, MXM190
- vesipyörän halk. 115 mm



FE363160

299671A1

- sopii: Case CS78, CS86, CS94 12/98 saakka

T5408

354190A1, 354273A1, 87720071, 83076697

- sopii: Case CS68, CS75, CS78, CS86, CS94 01/99 eteenpäin



18.08.2006

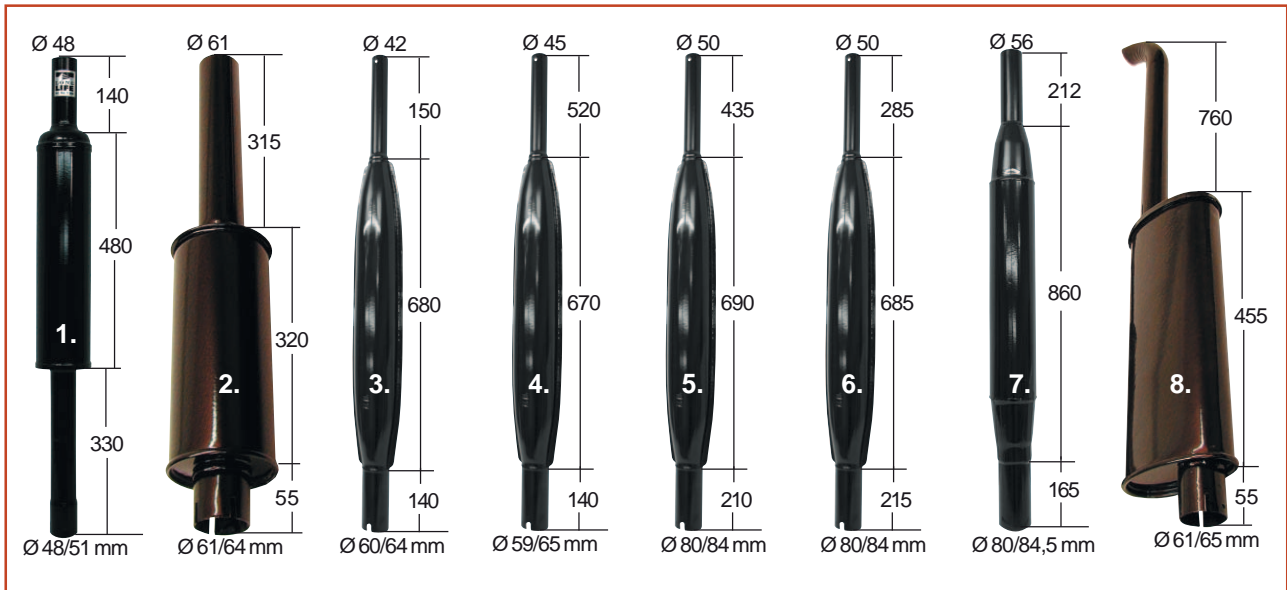

TRAKTORI-MALLI	KUVA	PAKO-PUTKI	PAKO-PUTKEN HATTU	PAKO-PUTKEN SIDE
250, 275, 276, 354, 374, 384, 414, 434, 444	1.	V868 K924341	VLD2054	LSSR50
475 454, 474, 574, 674	2.	T2036 529372R1	VLD2057	LSSR67
484, 485, 485XL, 584, 585 585XL, 684, 685, 685XL, 784	8.	T2037 83027C1		LSSR65
385, 433, 523, 533, 453, 624, 633, 644, 724, 824	3.	T2265 3216683R5	VLD2051	LSSR65
844, 844XL, 845, 845XL, 745, 745XL, 744	4.	T2264 3145624R9	VLD2052	LSSR67
955, 1055, 956, 1056 (+XL)	5.	T2259 3220369R96	VLD2054	LSSR83
856 (+XL)	6.	T2260 3404966R4	VLD2054	LSSR83
1255, 1455 (+XL)	7.	T2263 3226762R4	VLD2056	LSSR89
Maxxum 5120	9.	T2424 (a) A184460		
	10.	T2426 (b) A189049		
Maxxum 5130, 5140, 5150	9.	T2425 (a) A184475		
	10.	T2426 (b) A189049		

a - pellin alle

b - yläputki

PAKOPUTKEN MUTKAT + TIIVISTEET



26.09.2011

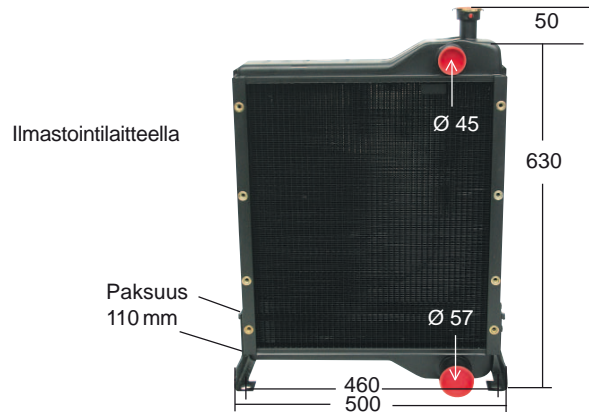
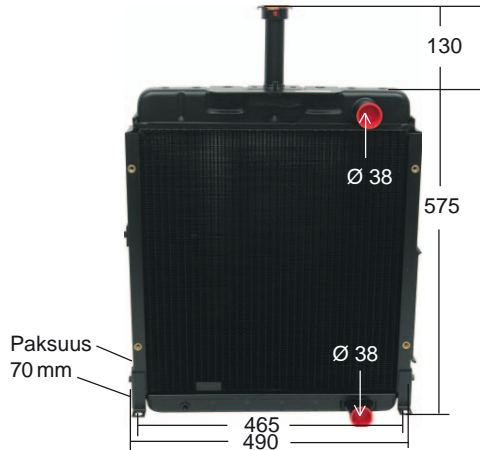

T2463

- 84524C93, 3121414R92, 3121413R91
 - 248, 258, 268, 385, 484, 485, 485XL, 584, 585, 585XL, 684, 685, 685XL, 784, 785, 785XL, 885, 885XL, 895XL
 - kokonaiskorkeus 705 mm
 - kiinnityslatta 165 mm, kiinnitysreiät Ø 14 mm, reikien väli 145 mm
 - sopiva korkki **T2242**
 - sisältää lauhduttimen kiinnityskorvakkeet

T2464

- 84673C6, 84673C5, 84673C4, 84673C3
 - 268, 288, 485XL, 585, 585XL, 595, 685, 685XL, 695, 695XL, 785, 785XL, 795, 795XL, 885, 885XL, 895, 895XL, 995XL
 - kokonaiskorkeus 680 mm
 - kiinnityslatta 180 mm, kiinnitysreiät Ø 18 mm, reikien väli 148 mm
 - ei sisällä korkkia eikä hanaa, hanan reikä takana
 - sopiva korkki **T2242**

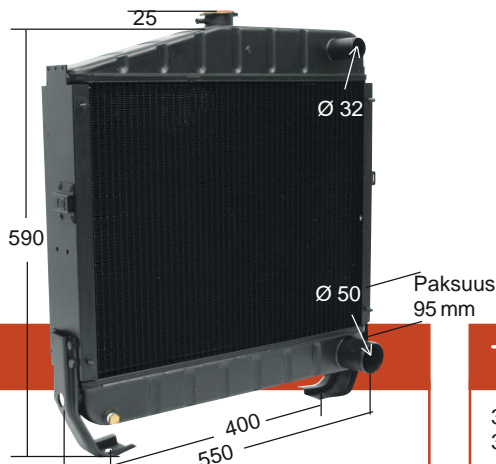

T2465

- 3399930R1, 3402579R1, 3404962R2
 - 743XL, 745XL, 844XL, 845XL
 - kokonaiskorkeus 615 mm
 - ei sisällä korkkia, hanan reikä tulpattu

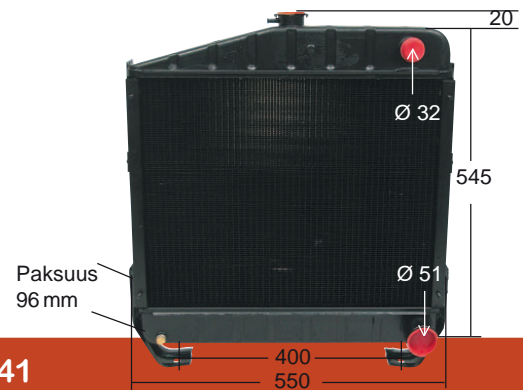

T2441

- 3145498R2, 3145498R3
 - 743, 744, 745
 - kokonaiskorkeus 615 mm, kiinnitysreiät Ø 13 mm
 - ei sisällä korkkia, hanan reikä tulpattu
 - sopiva korkki **T2242**

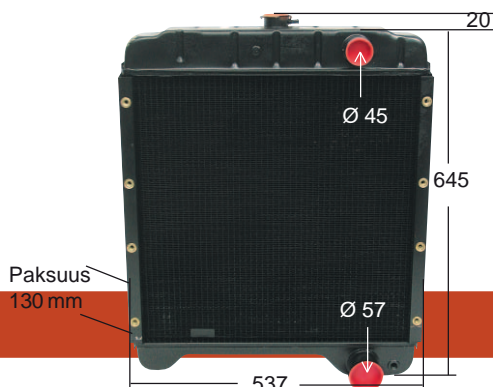

T2442

- 104753A1
 - 5120, 5130, 5140, 5150
 - kokonaiskorkeus 665 mm, takana kiinnityslatat

POLTTOAINETANKIN KORKKI

T20119

- 3210, 3220, 3230, 4210, 4220, 4230, 4240, 485XL, 495XL, 585, 585XL, 595, 595XL, 685, 685XL, 695, 695XL, 785XL, 885, 885XL, 895, 895XL, 995XL

08.05.2009

SIIRTOPUMPUT

T2257

3132697R9
- 454, 474, 484, 495, 574, 584, 585, 595, 674, 684, 685,
695, 784, 785, 795, 884, 885, 895, 3230, 4210, 4220,
4230 (+XL), 554, 624, 633, 644, 645, 654, 724, 733,
740, 743, 744, 745, 756, 833, 840, 844S, 844XL, 845,
845S, 845XL, 846, 856, 856XL, 946, 955, 956, 1046,
1055, 1056, 1246, 1255, 1255XL, 1455, 1455XL

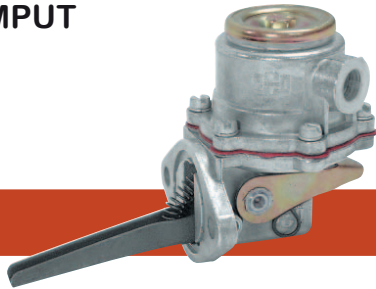

V557

708294R93
- 250, 275, 276, 354, 374,
384, 414, 434, 444, 450

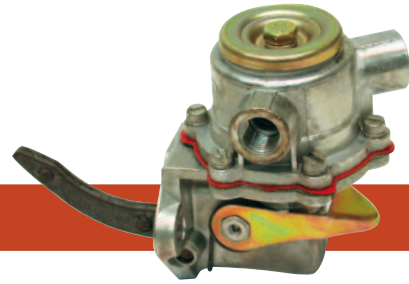

V555

3118234R91
- 475

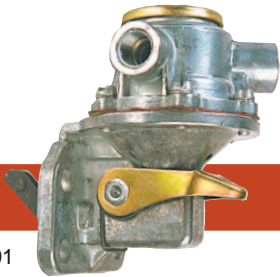

T2660

J904374, J928143
- Maxxum
5120, 5130,
5140, 5150,
5220, 5230,
5240



T5454

354236A1,
836659580
- CS68, CS75, CS78,
CS86, CS94, CS110, CS120,
CS130, CS150, CVX120, CVX130,
CVX150, CVX170, 9105, 9115,
9125, 9145

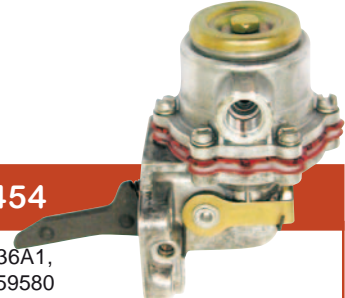

KÄSIPUMPPU

T20085

1202938C93
- Case IH 3210, 3220, 3230,
433, 533, 633, 733, 440, 540,
640, 840, 940, 4210, 4220, 4230,
4240, 485, 585, 685, 785, 885, 495,
595, 695, 795, 895, 995, 995XL,
248, 258, 268, 288

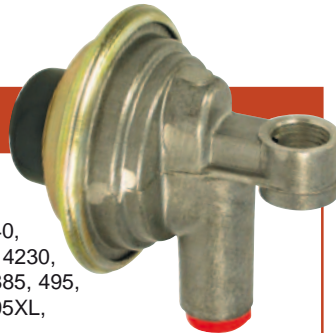

HEHKUVASTUS

T20109

- Case IH 275, 276,
354, 374, 414, 444, 434



HEHKUTULPAT

T0003

710348R1
- 0,9V
- 250, 275, 276, 354, 374, 384, 414,
434, 444



T2034

3112805R91
- 454, 474, 475, 574, 674



MF0441

K928523
- 385, 395, 484, 485, 495, 584, 585,
595, 684, 685, 695, 784, 785, 795,
884, 885, 895 (+XL), 5120, 5130,
3210, 3220, 3230, 4210, 4220, 4230,
4240



POLTTOAINELASIKUPIT

V298

3069610R1
- tyyppi: CAV
- tasainen pohja
- korkeus 54 mm
- reikä Ø 25,4 mm



T2033

3144478R1
- tyyppi: BOSCH
- kupera pohja
- korkeus 48 mm
- reikä Ø 9 mm



V299

3132197R1
- tyyppi: BOSCH
- kupera pohja
- korkeus 43 mm
- reikä Ø 17,4 mm





7 hyvää syytä vaihtaa uudet suutinkärjet:

1. säästät polttoainetta
2. pidempi moottorin käyttöikä
3. puhtaammat päästöt
4. lisää tehoa
5. enemmän vääntöä
6. parempi käynnistyvyys
7. tasaisempi käynti



SUUTINKÄRJET

TUOTENUMERO	SOVELTUVUUDET
SD42453 BDN4SD6453, 5643320 Lucas Cav	250, 275, 276, 414, 434, 444
SD70093 BDLL150S6511, 5621554 Lucas Cav	453, 454, 474, 484, 485, 523, 533, 574, 584, 585, 624, 674, 684, 685, 724, 784, 785, 824
SD70103 BDLL150S6555, 5621598 Lucas Cav	475
SD70106 BDLL150S6561, 5621604 Lucas Cav	475
SD70124 BDLL150S6602, 5621649 Lucas Cav	485A
SD70142 BDLL150S6649, 5621696 Lucas Cav	585A
SD71120 DLLA150S417, 0433271180 Bosch	321, 431, 444, 454, 474, 523A, 531, 544, 544HS, 574, 664, 724, 724A, 744, 744A, 824, 824A, 834, 844, 844S, 1046, 1046A, 1246, 1246A
SD71201 DLLA150S815, 0433271849 Bosch	684, 685, 695, 784, 785, 795, 884, 885, 895, 995 (+XL), 574HS, 743, 744, 744A, 745, 745XL, 833, 833S, 844, 844S, 844SA, 845, 856XLA, 955, 955XL, 956, 956XLA, 1046A, 1055, 1055XL, 1056XLA, 1246, 1246A
SD71211 DLLA150S843, 0433271834 Bosch	1255, 1455 (DT.358, DT.402 9/80-), 856, 956, 1056 (DT239 turbomoottorit)

ALUSLEVYT



T0402

- suutinkärjen kuparitiiviste
- koko 10 x 21 x 2 mm



T0401

- suutinkärjen kuparitiiviste
- koko 15 x 21 x 1,5 mm



T0400

- ylivuotoputken tiiviste
- koko 8 x 11 x 1 mm

E1.15

05.02.2010



VPM6002



VPM6001



VPM6005



T2400



ST0260



T2664

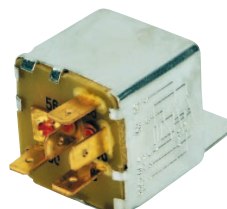

T20095

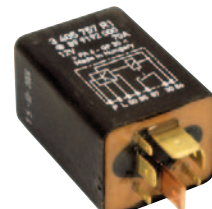

T20096



T20097



T20098



T20100



T20118

TUOTE- NUMERO	KATKAISIN	SOPIVUUS
VPM6002 91450C1 376855R92	ÖLJYNPAINEKELLO	248, 258, 278, 385, 395, 433, 440, 474, 475, 484, 485, 495, 495, 533, 540, 574, 584, 595, 595, 633, 640, 644, 674, 684, 685, 695, 733, 740, 743, 744, 745, 784, 785, 795, 833, 840, 844, 845, 856, 858, 884, 885, 895, 940, 956, 995, 1056, 3210, 3220, 3230, 4210, 4220, 4230, 4240, 6338, 6588, 6788
VPM6001 3060472R91	ÖLJYNPAINEKELLO	6000, 6500
VPM6005 376855R92	ÖLJYNPAINEKELLO	475, 5120, 5130, 5140, 5150, 5220, 5230, 5240, 5250, CX50, CX60, CX70, CX80, CX100
T2400 3127956R1	LÄMPÖMITTARIN ANTURI	238, 248, 258, 268, 288, 484, 584, 684, 784, 884, 385, 485, 485XL, 585, 585XL, 685, 685XL, 785, 785XL, 885, 885XL, 395, 495, 595, 695, 795, 895, 4240, 84 Hydro, 3210, 3220, 3230, 4210, 4220, 4230, 4240
ST0260 3142068R5	VILKKURELE	384, 385, 395, 484, 485, 495, 540, 584, 585, 595, 640, 684, 685, 695, 740, 743, 745, 784, 785, 795, 840, 844, 845, 856XL, 884, 885, 895, 955, 956, 995XL, 1055, 1056, 1255, 1455, 3210, 3220, 3230, 4210, 4220, 4230, 4240, CS48, CS52, CS58, CS63, CS68, CS75, CX50, CX60, CX70, CX80, CX90, CX100, 5120, 5130, 5140, 5150, MX100, MX110, MX120, MX135, MX150, MX170, 7110, 7120, 7130, 7140, 7210, 7220, 7230, 7240, 7250, AVJ55, AVJ60, AVJ70, VJ60, VJ70, VJ80
T2664 3141102R92	VILKKURELE	644, 734, 744, 745S, 844, 844S
T20095 1502351C1 3221178R1	AJOVALORELE 12V - 2 x 150W	433, 433E, 433V, 440, 485XL, 495XL, 533, 533E, 533V, 540, 585XL, 595XL, 633, 633E, 633V, 640, 685XL, 695XL, 733, 733E, 740, 743, 743XL, 745S, 745XL, 785XL, 795XL, 833, 833E, 840, 844S, 844XL, 845, 845XL, 856XL, 885XL, 895XL, 933, 940, 956, 956XL, 995XL, 1056, 1056XL, 1255, 1255XL, 1455, 1455XL, 3210, 3220, 3230, 4210, 4220, 4230, 4240, 5120, 5130, 5140, 5220, 5230, 5240, 5250, C50-C90, CX50-100, MX80C-MX100C, MX100-MX120, MX135, MX150, MX170
T20096 3405757R1	HEHKURELE 12V - 70A	743XL, 745XL, 844XL, 856XL, 956, 956XL, 1056, 1056XL, 1255, 1255XL, 1455, 1455XL, 3210, 3220, 3230, 4210, 4220, 4230, 4240
T20097 1987452C1	TURVAKÄYNNISTIN 12V - 70A	3210, 3220, 3230, 4210, 4220, 4230, 4240, 5120, 5130, 5140, 5150, 5220, 5230, 5240, 5250, CX50, CX60, CX70, CX80, CX90, CX100, MX100, MX110, MX120, MX135
T20098 1983394C2	LÄMMITYSLAITTEEN RELE	743XL, 745XL, 844XL, 845XL, 856XL, 3210, 3220, 3230, 4210, 4220, 4230, 4240
T20100 3114409R92	VAIHTEISTON TURVAKATKAISIN	354, 374, 384, 444, 454, 474, 475, 484, 485, 495, 574, 584, 585, 595, 684, 685, 695, 784, 785, 795, 884, 885, 895, 995XL, 3210, 3220, 3230, 4210, 4220, 4230, 4240
MF1228 218323A1, 340521A1	PYSÄYTIN- SOLENOIDI	CX70, CX80, CX90, CX100, MX80, MX90, MX100
T20118	PAINEANTURI	1056, 1056XL, 743XL, 745XL, 844XL, 845XL, 856XL, 956XL

22.10.2010

Katkaisimien tarvikkeet ja symbolit - Katso Tarvikekuvasto T2

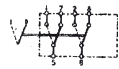

ST7073



ST7074



ST7075

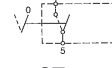

ST7076

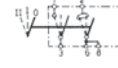

ST7088

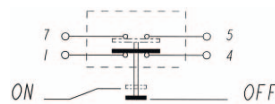
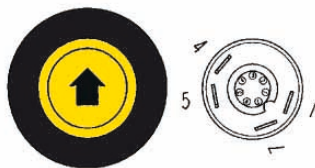

ST7047

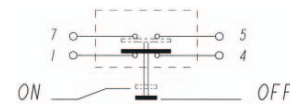
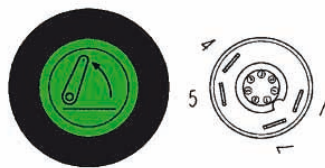

ST7037



MF1202



F1011

TUOTE- NUMERO	SYMBOLI	KATKAISIN	NAPA- LUKU	SOPIVUUS
ST7073 1964835C1		KYTKIN 4-VETO	6	C50, C60, C80, C90, C100, 485XL, 540, 585XL, 640, 740, 743XL, 745XL, 785, 785XL, 795, 795XL, 840, 844XL, 845XL, 856 XL, 855, 855XL, 895, 895XL, 940, 956XL, 995XL, 1056XL, 1255XL, 1455XL, 3210, 3220, 3230, 4210, 4220, 4230, 4240, 5120, 5130, 5140, 5150, 7110E, 7120E, 7130, 7140, 7210, 7220, 7230, 7240, 7250
ST7074 245911C1 3223052R1	ST7120	LASIN- PYYHKIJÄ	4	485XL, 495XL, 585XL, 595XL, 685XL, 695XL, 743XL, 745XL, 785XL, 795XL, 844XL, 845XL, 856XL, 885XL, 895XL, 956XL, 995XL, 1056XL, 1255XL, 1294, 1394, 1455XL, 1494, 1594, 3210, 3220, 3230, 4210, 4220, 4230, 4240, 7210, 7220, 7230, 7240, 7250
ST7075 245908C1 3221208R1	ST7114	VAROITUS- VILKKU	6	C50, C60, C70, C80, C90, C100, CX50, CX60, CX70, CX80, CX90, CX100, MX100, MX110, MX120, MX135, MX150, MX170, MX80C, MX90C, MX100C, 238, 248, 258, 268, 288, 395, 440, 485XL, 495, 495XL, 540, 585XL, 595, 595XL, 640, 685, 685XL, 695XL, 740, 743XL, 745XL, 785, 785XL, 795, 795XL, 840, 844XL, 845XL, 856XL, 885, 885XL, 895, 895XL, 940, 956XL, 1056XL, 1255XL, 1455XL, 3210, 3220, 3230, 4210, 4220, 4230, 4240, 5120, 5130, 5140, 5150, 7110E, 7120E, 7130, 7140, 7210, 7220, 7230, 7240, 7250
ST7076 245909C1 3402632R1	ST7108 oranssi ST7109 vihreä	TYÖVALOT	2	C50, C60, C70, C80, C90, C100, CX50, CX60, CX70, CX80, CX90, CX100, MX100, MX110, MX120, MX135, MX150, MX170, MX80C, MX90C, MX100C, 238, 248, 258, 268, 288, 395, 485, 485XL, 495, 495XL, 585, 585XL, 595, 595XL, 685, 685XL, 695, 695XL, 743XL, 745XL, 785, 785XL, 795, 795XL, 844XL, 845XL, 856XL, 885, 885XL, 895, 895XL, 956XL, 995XL, 1056XL, 1255XL, 1455XL, 3210, 3220, 3230, 4210, 4220, 4230, 4240, 5120, 5130, 5140, 5150, 7110E, 7120E, 7130, 7140, 7210, 7220, 7230, 7240, 7250
ST7088 245910C1 3221180R1	ST7101	AJOVALOT	5	238, 248, 258, 268, 288, 395, 440, 485XL, 495, 495XL, 540, 585XL, 595, 595XL, 640, 685, 685XL, 695, 695XL, 740, 743XL, 745XL, 785, 785XL, 795, 795XL, 840, 844XL, 845XL, 856XL, 885, 885XL, 895, 895XL, 940, 956XL, 995XL, 1056XL, 1255XL, 1455XL, 3210, 3220, 3230, 4210, 4220, 4230, 4240
ST7047 1964848C1		PAINONAPPI- KATKAISIN YLOS/ALAS	4	5120, 5130, 5140, 5150, 5220, 5230, 5240, 5250
ST7037		PAINONAPPI- KATKAISIN HYDR. YLOS	4	CS48, CS52, CS58, CS63, CS68, CS75, CS78, CS86, CS94, CS100, CS110, CS120, CS130, CS150
MF1202 218323A1		PYSÄYTIN- SOLENOIDI		CX70, CX80, CX90, CX100, MX80C, MX90C, MX100C
F1011		JARRUVALON KATKAISIJA		CIH JX100U, JX1070U, JX1080U, JX1090U, JX1100U, JX70U, JX80U, JX90U, MXM120, MXM130, MXM140, MXU100, MXU110, MXU115, MXU125, MXU130

25.07.2008



T20104



T2663

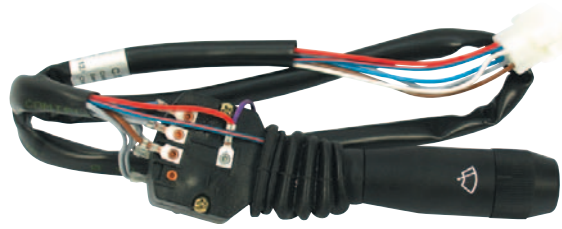

F0678

TUOTE-NUMERO	KATKAISIN	NAPA-LUKU	SOPIVUUS
T2663 1534361C2	YHDISTELMÄ-KYTKIN	6	Maxxum 5120, 5130, 5140, 5150
F0678 82011624	YHDISTELMÄ-KYTKIN TUULILAŠIN PYYHKIJÄ		MXM120, MXM130, MXM140, MXM155, MXM175, MXM190
T20104 3399522R2	YHDISTELMÄ-KYTKIN ÄÄNITORVI, VILKKU		743XL, 745XL, 844XL, 845XL, 856XL, 955XL, 956, 956XL, 1055XL, 1056, 1056XL, 1255, 1255XL, 1455, 1455XL, 3210, 3220, 3230, 4210, 4220, 4230, 4240

22.10.2010

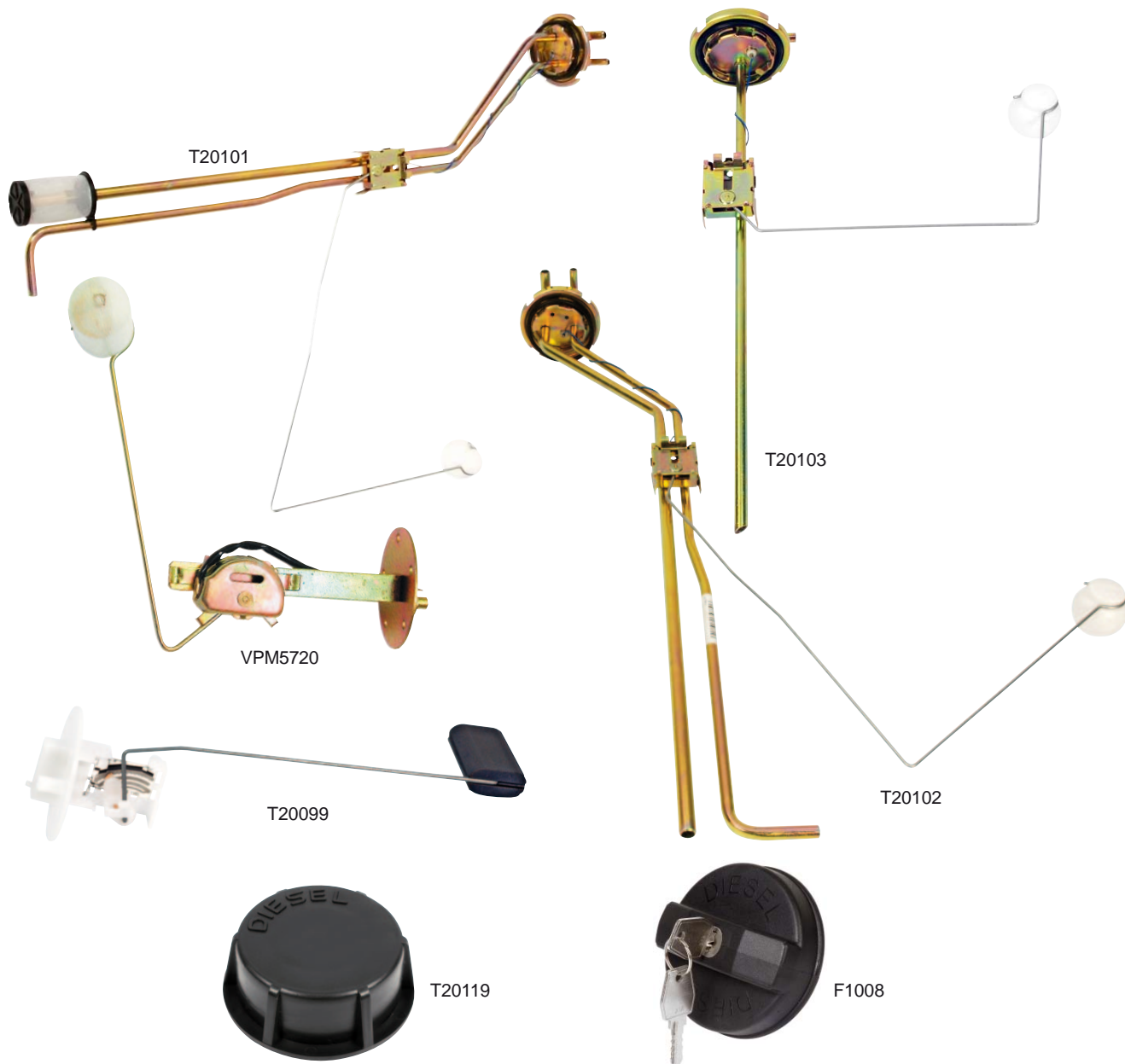

TUOTE- NUMERO

VPM5720 1500494C92	POLTTOAINE- MITTARIN ANTURI	485XL, 495XL, 585, 585XL, 595, 595XL, 685, 685XL, 695, 695XL, 785, 785XL, 795XL, 885, 885XL, 895, 895XL, 995, 995XL
T20099 134122A1	POLTTOAINE- MITTARIN ANTURI	3210, 3220, 3230, 4210, 4220, 4230, 4240 AVJ55, AVJ60, AVJ70, VJ60, VJ70, VJ90
T20101 1533805C1	POLTTOAINE- MITTARIN ANTURI	→JJF1050110: 5120, 5130, 5140, 5150, 5220, 5230, 5240, 5250
T20102 130915A1	POLTTOAINE- MITTARIN ANTURI	JJF1050111→: 5120, 5130, 5140, 5150, 5220, 5230, 5240, 5250
T20103 3232250R91	POLTTOAINE- MITTARIN ANTURI	743XL, 745XL, 844XL, 845XL, 856XL, 955, 955XL, 956, 956XL, 1055, 1055XL, 1056, 1056XL, 1255, 1255XL, 1455, 1455XL
T20119 1500254C1	POLTTOAINE- TANKIN KORKKI	3210, 3220, 3230, 4210, 4220, 4230, 4240, 485, 585, 595, 685, 695, 785, 795, 885, 895, 995 + XL-malli
F1008 226384A1	POLTTOAINE- TANKIN KORKKI lukittava	3210, 3220, 3230, 4210, 4220, 4230, 4240, CX70, CX80, CX90, CX100, MX100, MX100C, MX110, MX120, MX135, MX150, MX170, MX80C, MX90C, MXM120, MXM130, MXM140, MXM155, MXM175, MXM190

VAIHTOVIRTA- LATURI 65A

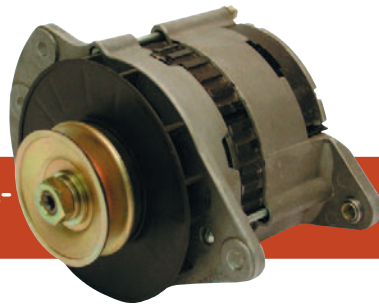

ST0210

- 15/5599
 - yleismalli
 - sisältää tuulettimen ja siivan
 - soveltuu useimpiin 12 V järjestelmien 28-65 A tehoisten latureiden tilalle
 - w-liittimellä

VAIHTOVIRTA- LATURI 70A



ST0215

- 3129851R91, 15/1276
 - sisältää tuulettimen ja siivan
 - sopii: 385, 395, 3210, 485, 495, 3220, 585, 595, 3230, 684, 685, 695, 4210, 785, 795, 4220, 885, 895, 4230, 995, 4240
 - w-liittimellä

VAIHTOVIRTA- LATURI 18 ACR 45A

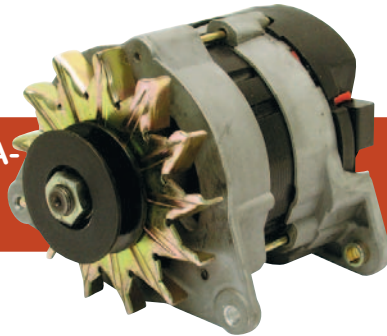

ST0005

- 35339303, 510E249
 - teho 630W, jännitteen säädin ST0005-10 (VR9001A)

ST0001

TASAVIRTA- LATURI



ST0001

- K908882
 - 22A
 - pikkulucas C40
 - teho 300W
 - LRD 100

ST0003

- 11A
 - suljettu

ST0002

- K928643
 - 22A

PIKKULUCAS TASAVIRTAALATURIN VARAOSAT



HIILISARJA

VETO-
PÄÄTY

VETOPÄÄN
LAAKERI

HIILIPÄÄN
PUSLA

SIIVA-
PYÖRÄ

RELE
LATA-
LIITTIMILLÄ

RELE
PYÖREILLÄ
LIITTIMILLÄ

ST0013
1024034M91

ST0012

L6302-2RS

ST0016

ST0009
731003M1

ST0080
894835M1

ST0081
826788M1

LUCAS 18 ACR VAIHTOVIRTAALATURIN VARAOSAT

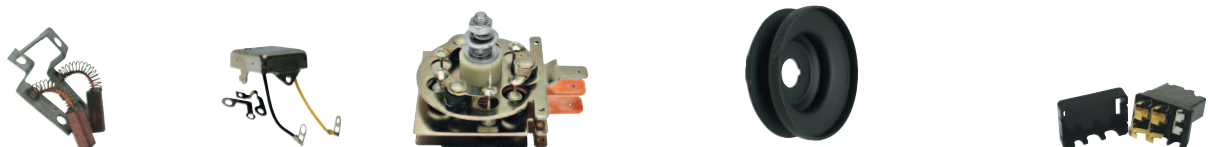

HIILISARJA

SÄÄDIN

DIODISILTA

SIIVA-
PYÖRÄ

SIIVA-
PYÖRÄ

LIITIN-
SARJA

ST0024
836115425

ST0020
836115797

ST0021
836115798

ST0022
9,5 x 63 mm

ST0022B
12,5 x 90 mm

ST0025

E1.18

05.02.2010

ST0152

3228193R91

- 9-hampainen
- sopii: 523, 624, 724, 744, 745, 824, 844, 856, 946, 845, 955, 956, 1046, 1055, 1056, 1246, 1255, 1455

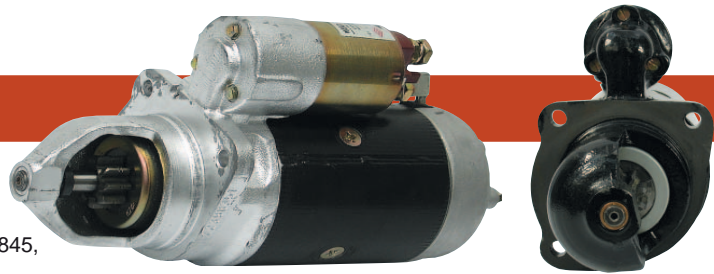

ST0187A

3046890R91

- M45
- LRS172
- sopii: 250, 275, 276, 414, 434, 444

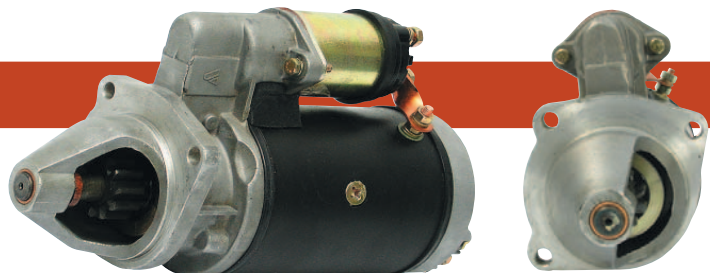

ST0192

3116683R91

- LRS162
- sopii: 475



ST0193A

OEM: 529965R92, 189330A5,
114568A1, 114568A2,
114568A3, 189330A3

- M127
- LRS240
- sopii: 474, 574, 674, 484, 584, 684, 784, 485, 585, 685, 785, 885, 454, 895, 3210, 3220, 3230, 4210, 4220, 4230, 4240, XL-mallit



04.03.2011

ST0216

3228192R1
 - 11-hampainen
 - sopii: 423, 433,
 533, 633



SM2834A

- tehostartti HD 230
 - sopii: CS110, CS120, CS130, CS150

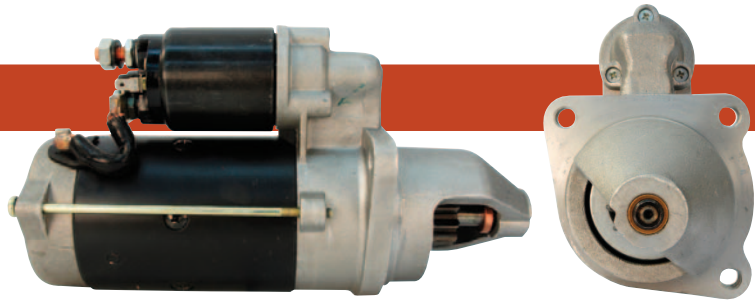

SM2822A

- tehostartti HD 230
 - sopii: MX80CX, MX90CX, MX100CX,
 MX100CC (Perkins-moottorilla)

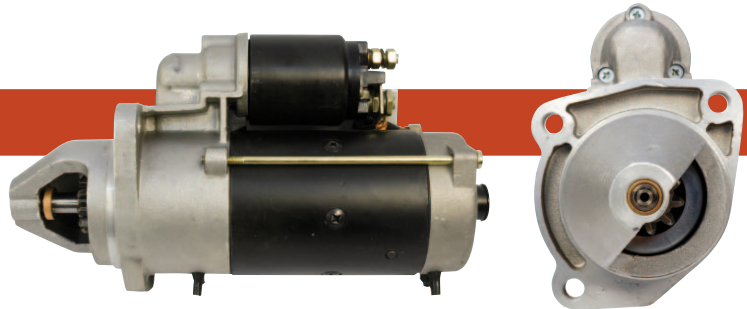

ST35210

835331592, 133200009075
 - sopii: CS110, CS120, CS130,
 CS150,
 - 12 V
 - 4,0 kW
 - 11 hammasta
 - LRS 147

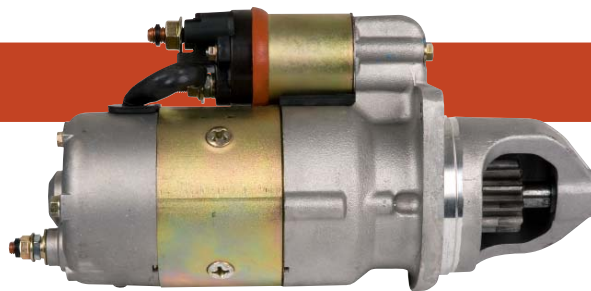

ST35230

3821818M
 - sopii: MX80CX, MX90CX, MX100CX
 MX100CC
 - M127
 - Massey Ferguson 165-malli A4.212-
 moottorilla

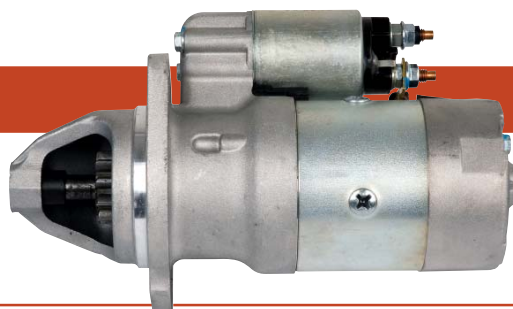

E1.18b

08.05.2009

**STARTTI-
KEHÄ****T20075**

3144607R1

- sopii: 743, 745S, 844, 844S, 844XL,
845, 845XL, 856XL, 955, 955XL,
956, 956XL, 1055, 1055XL,
1056, 1056XL, 1255, 1255XL,
1455, 1455XL

A=357 mm
Z 134

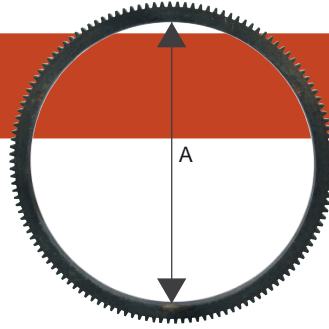
**STARTTI-
KEHÄ****T20076**

3055133R1

- sopii: 454, 553, 644, 654, 724,
743, 743XL, 744, 745S, 745XL, 824,
845, 946, 1046, 1246, 2400

A=357 mm
Z 129

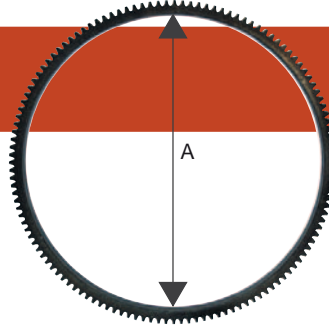
**STARTTI-
KEHÄ****T20105**

60883H

- sopii: 258, 268, 454, 474, 484, 485,
495, 574, 584, 585, 595, 674, 684, 685,
695, 784, 785, 795, 85, 3210, 3220,
3230, 4120, 4220
- A=370 mm, Z 126

**STARTTI-
KEHÄ****T20111**

3218637R1

- sopii: 288, 4230, 4240, 884, 885,
885XL, 895, 895XL, 995XL

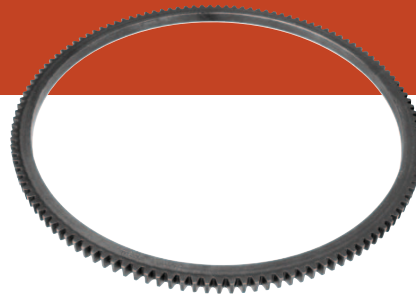

26.09.2011

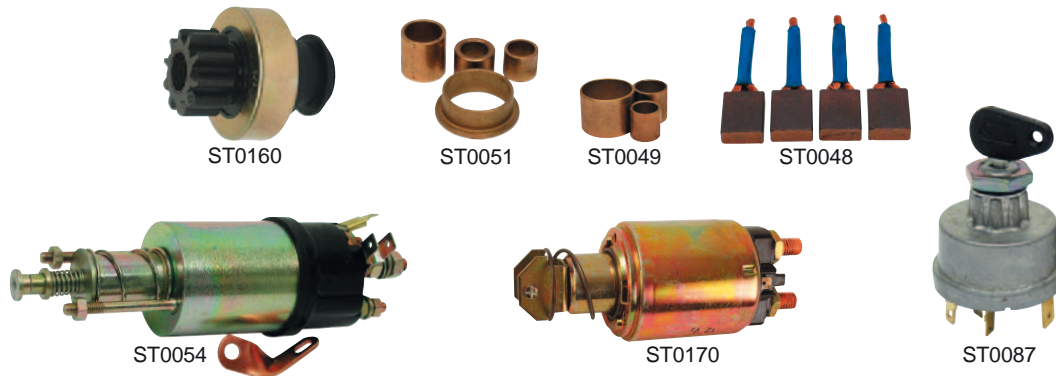

TRAKTORI-MALLI	SOLE-NOIDI	KENTTÄ-KÄÄMIT	HIILI-SARJA	BENDIX-RATAS	HELA-SARJA	VIRTA-LUKKO	SOLE-NOIDI
523, 624, 724, 744, 745, 824, 844, 856, 946, 845, 955, 956, 1046, 1055, 1056, 1246, 1255, 1455	ST0170 (Marelli) 0331401008 ST0171 (Bosch) 0331402001					ST0211 (c,e) 3136852R1 ST0178A (c) 1532371C1	
250, 275, 414, (M45G)		ST0045 3062381R91	ST0047 K962799			ST0049 (a) 3113029R91 ST0050 (b) 3113029R91	ST0053 3109131R91
250, 275, 276, 414, 434, 444	ST1067 3111040R91	ST0045 3062381R91	ST0047 K962799	ST0160 3114822R91	ST0049 (a) 3113029R91		
475	ST0054 3206518R2	ST0046A (d) 3062381R91	ST0048 705833R91	ST0062 3114822R91	ST0051 K963791	ST0087 K203992	
474, 574, 674, 484, 584, 684, 784, 485, 585, 685, 785, 454, 895	ST1072	ST0046A (d) 3062381R91	ST0048 705833R91	ST0062 3114822R91	ST0051 K963791	ST0087 K203992	
423, 433, 533, 633						ST0211 (e) 3136852R1	
Maxxum 5120, 5130, 5140, 5150						T2681 1987424C1	
C42, C48, C55, C64, C70, CS70, CS68, CS75						T2682 135700580118	
CS78, CS86, CS94, CS110, CS120, CS130, CS150, CVX120-CVX170						T2683 140258008	
276, 434, 444, B250, B275, B414						ST0086 3048227R92	
323, 353, 383, 453, 644, 654, 733, 743, 743XL, 745XL, 833, 844XL, 845XL						ST0211 (e) 3136852R1	

- a - ankkurin halkaisija vetopäässä 12,7 mm
 b - ankkurin halkaisija vetopäässä 14,0 mm
 c - saksalaiset mallit -81 = ST0211
 XL ohjaamolla varustetut mallit = ST0178A (1987424C1)
 d - ST0046A kahdella liitäntäjohtolla
 e - P-0-1-2-3

CAV CA 45 STARTTIMOOTTORIN VARAOSAT

IH 275, 276, 414, 434, 444

Huom. Katso startin tyyppi tilatessasi varaosia

TYYPPI	ANKKURI	HIILI-SARJA	HELA-SARJA	SOLENOIDIN KÄRJET KIINTEÄ/ LIIKKUVA	SOLENOIDI KAAPELIN VÄLIIN
CA 45 C	ST0063	ST0065 (a)	ST0066		ST0053
CA 45 D	ST0063	ST0065 (a)	ST0066	ST0072	ST0053



ST0053

a - 9 x 20 mm, pituus 25,5 mm

E1.20

Alkuperäisnumerot ovat ainoastaan vertailua varten, eivätkä tarkoita, että tuotteet ovat alkuperäisiä. Taulukoissa esiintyvät kuvat ovat viitteellisiä.

26.09.2011

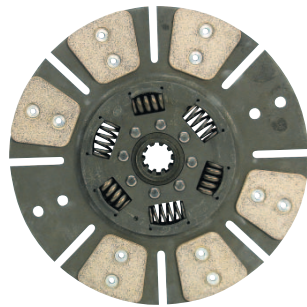

LUK328017541

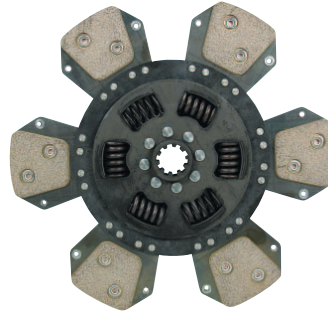

LUK331015411



LUK500039800



L6204-2RS

TRAKTORI-MALLI	KOKO Ø	ASETELMA	KYTKIN-LEVY orgaani	KYTKIN-LEVY keraaminen	PAINE-LAAKERI	SILMÄ-LAAKERI
250	250 mm		LUK325014116			
275, 276	250 mm		T2073 3040412R91		LUK500059011 (e) 705542R91 3070635R91	LUK410002600 L6204-2RS 537290R91
275 (50976→), 276, 414, 434, 444	280 mm	LUK128006810 (3) T5033 (3) 3067300R92	LUK328017310 V8823 3074827R91		LUK500059011 (e) 705542R91 3070635R91	LUK410002600 L6204-2RS 537290R91
454, 474, 475, 484, 485, 485XL, 495, 495XL, 574, 584, 585, 585XL, 595, 674 (n), 684, 685, 685XL, 695, 695XL, 784, 785, 785XL, 795, 795XL, 884, 885, 885XL, 3400, 3434, 3500	280 mm	LUK128005511 (3) 1500655C92	LUK328017510 (b) T2205 1002338C2 1944250C1	LUK328017541 (c) 1944263C1 LUK328017542 (d) 3129834R2	LUK500104650 85104C91	LUK410002600 L6204-2RS 537290R91
(n): 3210, 3220, 3230	280 mm	LUK128005511 (3) 1500655C92	LUK328017510 (b) T2205 1002338C2	LUK328017541 (c) 1944263C1	LUK500104650 85104C92	LUK410002600 L6204-2RS 537290R91
453, 423	250 mm	LUK125001220 (3) 3139819R91	T2083 3058676R91	LUK325007926(f)	LUK500011520 (e) 715575R11	
624, 724, 824	280 mm	LUK128001820 (h, 3) 3057150R92	LUK328017510 (m) T2205 1002338C2 T0019 (j) 1002338C2	LUK328017541 (c) 1944263C1	LUK500011520 (e) 715575R11	LUK410002600 L6204-2RS 537290R91
844	280 mm	LUK128002520 (k, 3)	LUK328017510 (m) T2205 1002338C2	LUK328017541 (c) 1944263C1	LUK500039800 tai 3147877R91 LUK500011520 (e) 715575R11	
614, 634	310 mm		T6503			
454, 464, 474, 484, 574, 584, 674, 684, 784, 884	310 mm	LUK131003811 (3) 85025C2	VPG2307A 85026C2	LUK331015411	LUK500104650 85104C91	LUK410002600 L6204-2RS 537290R91
385, 395, 475, 485, 485XL, 495, 495XL, 585, 585XL, 595 (n), 685, 685XL, 695, 695XL, 785, 785XL, 795, 795XL, 885, 885XL, 895, 985, 995, 2400, 3400	310 mm	LUK131003811 (3) 85025C2	VPG2307A 85026C2	LUK331015411	LUK500104650 85104C91 T2074N (n) 1970876C3	LUK410002600 L6204-2RS 537290R91
(n): 3210, 3230, 4210, 4220, 4230, 4240, 4210XL, 4220XL, 4230XL, 4240XL	310 mm	LUK131003811 (3) 85025C2	VPG2307A 85026C2	LUK331015411	LUK500104650 85104C92	LUK410002600 L6204-2RS 537290R91
CX50, 60, 70 CX80, 90, 100	310 mm	LUK131025410 (3) 223807A1		LUK331023510 (o) 330732A1	LUK500104650 85104C92	LUK410002600 537290R91

a - erikoisvahvistettu malli kaksoispainajousilla, vaihtoehtoinen T2076 tilalle

b - erikoisvahva levy

c - 6-lapainen

d - 8-lapainen

e - painehilli

f - 10 mm

h - käpälissä painelaakerin vastinrenkas

k - käpälissä ei painelaakerin vastinrengasta

l - keskireikä 32 mm

m - keskireikä 28,5 mm

n - nylon-painelevy T2074N painelaakerin ja kytinkäpälien välin uudemmissa malleissa

o - 7-lapainen

3 - ei levyä

KESKIÖRASVA

LUK414001410

- erityisesti kytinkeskiöihin ja -akseleihin



26.09.2011



LUK230001114

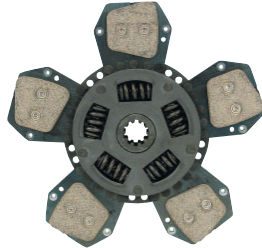

LUK330001512



T5029



LUK500039800



LUK500040000



L6204-2RS

TRAKTORI-MALLI	KOKO Ø	ASETELMA	KYTKINLEVY AJO	VOIMAN ULOSOTTO	PAINELAAKERI AJO	VOIMAN ULOSOTTO	SILMÄ- LAAKERI
275, 276	280/228 mm	LUK228007441 (2) 1539021C1	LUK328017310 1539026C1 V8823	V8795 1539020C1			LUK410002600 L6204-2RS 537290R91
414, 434, 444	280/228 mm	LUK228007541 (2) 1539022C1	LUK328017310 1539026C1 V8823	V8795 1539020C1			LUK410002600 L6204-2RS 537290R91
453, 533	228/250 mm	LUK225004411 (2) 3216398EX	LUK325007926 (c) T2083 3058676R91				
533	228/290 mm		LUK329000116 1964150C1				
523, 553, 554, 564, 624, 644, 654, 724, 734, 743, 744, 745S, 754, 824, 834, 844, 845, myös S-, XL-, XLA- ja XLN-mallit	280/300 mm	LUK230001114 (2) 135506A1 LUK630109009 (a) 135506A2	LUK330001516 (b) 3225950R1 T2159 LUK330001512 (c) 1964224C1 LUK328017510 (b, g) 1002338C2 T2205 (b) 3058405R93 LUK328017541 (k, g) 1944263C1 LUK328017542 (c, l)	T2189 135507A1	LUK500039800 3134147R91	LUK500040000 3142860R91	LUK410002600 L6204-2RS 537290R91
1046	280/280 mm	LUK228003810 (1) 314565R93	LUK328010710 3141567EX	LUK328015316 T2191 3141177R91 T2191A (h)	LUK500039800 3134147R91	LUK500040000 3142860R91	LUK410002600 L6204-2RS 537290R91
856, 955, 956, 1055, 1056	310/310 mm	LUK231002314 (2) 1964221C1 LUK631136409 (a, o) 3220807R94	LUK331007511 (c) 3224423R93	LUK331007311 T5029 1964222C2	LUK500039800 3134147R91	LUK500040000 3142860R91	LUK410002600 L6204-2RS 537290R91
1246	310/310 mm		LUK331001110 3147053R1		LUK500039800 3134147R91	LUK500040000 3142860R91	LUK410002600 L6204-2RS 537290R91
1255	350/350 mm	LUK235000310 (1,c,m) 1964058C1		LUK335007911 T2197 1964090C1	LUK500039800 3134147R91	LUK500040000 3142860R91	LUK410002600 L6204-2RS 537290R91
1255 HYDRO	350/350 mm	LUK235000410 (1,c,n) 1964059C1	LUK335008110	LUK335007911 T2197 1964090C1	LUK500039800 3134147R91	LUK500040000 3142860R91	LUK410002600 L6204-2RS 537290R91
1455	350/350 mm	LUK235000310 (1,c,m) 1964060C2		LUK335007911 T2197 1964090C1	LUK500039800 3134147R91	LUK500040000 3142860R91	LUK410002600 L6204-2RS 537290R91
1455 HYDRO	350/350 mm	LUK235000310 (1,c,m) 1964060C2 LUK235000410 (1,c,n) 1964059C1	LUK335008110	LUK335007911 T2197 1964090C1	LUK500039800 3134147R91	LUK500040000 3142860R91	LUK410002600 L6204-2RS 537290R91

a - kytkinpaketti asetelma, keraaminen ajolevy ja vo-levy
b - orgaani
c - keraaminen
f - 11,5 mm

g - sopii vanhaan F&G kytkimeen Ø 280 mm
h - vanhemmissa kytkimissä 295 mm
k - 275 mm 6-lapainen
l - 275 mm 8-lapainen

m - jousitettu keskiö
n - kiinteä keskiö
o - pultit 12 x PKC516X4
1 - ajolevy
2 - VO-levy

V.O.PAKAN VÄLILEVY

T20112

3125322R1, 3125322R2, 401716R2, 401716R3
- 45 hampainen
- 6 kpl/traktori
- 3210, 3220, 3230, 385, 395, 395XL, 4210, 4220, 4230, 4240,
454, 474, 475, 484, 485, 485XL, 495, 495XL, 574, 584, 585,
585XL, 595, 595XL, 674, 684, 685, 685XL, 695, 695XL, 784,
785, 785XL, 795, 884, 885, 885XL, 895, 895XL, 995XL, CX100,
CX50, CX60, CX70, CX80, CX90

V.O.PAKAN VÄLILEVY

T20113

3125147R1
- 6 harjaparia
- 5 kpl/traktori
- 3210, 3220, 3230, 395, 395 XL, 4210, 4220, 4230, 4240,
495, 495 XL, 595, 595 XL, 685, 685 XL, 695, 695 XL, 785,
785 XL, 795, 884, 885, 885 XL, 895, 895 XL, 995 XL,
CX100, CX50, CX60, CX70, CX80, CX90

26.09.2011



T2108



T2112



T2116



V1282



V1284

TRAKTORI-MALLI	OLKA-AKSELIN KORJAUS-SARJA (a)	OLKA-AKSELIN PUSLA	PAINE-LAAKERI	ETU-PYÖRÄN PULTTI (b)	ETU-PYÖRÄN MUTTERI
275, 276	T2107	V3141 40090D	V3142 39862D		V1284 69957H
414, 434, 444	T2107	V3141 40090D	V3142 39862D		V1284 69957H
454, 474	T2108	T2112 358958R2		V1282 528803R1	V1284 69957H
475, 574, 674	T2108	T2112 358958R2		V1282 528803R1	V1284 69957H
484, 584	T2108	T2112 358958R2		V1282 528803R1	V1284 69957H
684, 784, 884	T2108	T2112 358958R2		V1282 528803R1	V1284 69957H
385, 485, 585	T2108	T2112 358958R2		V1282 528803R1	V1284 69957H
685, 785, 885	T2108	T2112 358958R2		V1282 528803R1	V1284 69957H
523		T2113 3405571R1	T2116 3057058R91		T2069 933948R1
624, 724		T2113 3405571R1	T2116 3057058R91		T2069 933948R1
433, 533, 633, 733			T2116 3057058R91		
644, 744, 844, 844S, 743, 745S			T2116 3057058R91		
856, 856XL		T2113 3405571R1	T2116 3057058R91		
955XL, 1055XL, 956XL, 1056XL, 955, 1055, 956, 1056, 1046, 1246		T2113 3405571R1			

a - olka-akselin korjaussarja, sisältää: 4 x pusla, 2 x painelaakeri, 2 x pölytiiviste
b - pituus 50,47 mm, UNF 1/2"

25.07.2008

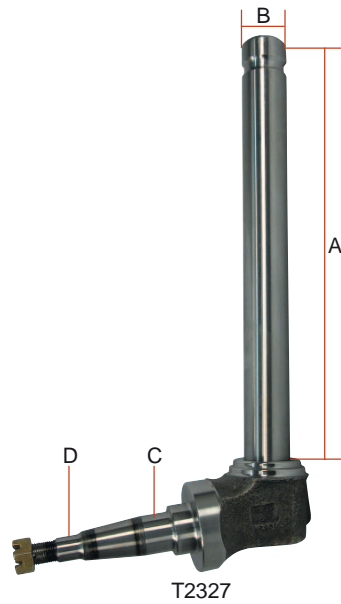

TRAKTORI-MALLI	OLKA-AKSELI	A mm	B mm	C mm	D mm	PYÖRÄN-NAPA HD	NAVAN PÖLY-KUPPI	ETU-PYÖRÄN LAAKERI-SARJA	OLKA-AKSELIN KORJAUS-SARJA
Englantilaiset takavetomallit 238, 248, 258, 268, 288, 454, 474, 475, 574, 674, 484, 584, 684, 784, 884, 385, 485, 485XL, 585, 585XL, 685, 685XL, 785, 785XL, 885, 885XL, 395, 495, 495XL, 595, 595XL, 695, 695XL, 795, 795XL, 895, 895XL, 995XL, 3210, 3220, 3230, 4210, 4220, 4230, 4240, 84 Hydro		309	42,5	35	21,5			V7202 109405R92	T2108
	T2327 67526C91	390	42,5	35	21,5			V7202 109405R92	T2108
	T2333 3121261R91	285	42,5	45,3	35	T2273 67527C92	T2698 612884R1	T2064 1094034R93	T2108
	T2328 67535C91	309	42,5	45,3	35	T2273 67527C92	T2698 612884R1	T2064 1094034R93	T2108
	T2271 67526C91	390	42,5	45,3	35	T2273 67527C92	T2698 612884R1	T2064 1094034R93	T2108

TRAKTORI-MALLI	ETUPYÖRÄN LAAKERI-SARJA
250, 275, 276, 414, 434, 444	V7201 1094017R92
385, 454 (h), 474, 475, 484, 485, 574 (a), 584 (a), 585 (a), 674 (a, k)	V7202 109405R92
385, 484, 485, 574 (b), 584 (b), 585 (b), 674 (b, j), 684, 685, 784, 785, 884, 885	T2064 1094034R93
433, 533 (f), 453, 633	T2145
433, 533 (g), 633, 644, 733, 743, 744, 745, 745S, 844, 856 (a), 856XL	T2146 (l)
844S, 845, 946, 955, 955XL, 956, 956XL, 1046, 1055 (a), 1055XL, 1056 (a), 1056XL, 1246	T2147 (m)



- a - normaalilla etuakselilla
- b - vahvistetulla etuakselilla
- f - sarjanumeroon →010654
- g - sarjanumerosta 010655→
- h - suora etuakseli
- j - sarjanumerosta 101083→
- k - sarjanumeroon →101082
- l - ulomman laakerin ulkohalkaisija 59 mm
- m - ulomman laakerin ulkohalkaisija 62 mm

08.01.2007



Sarja sisältää: laakerit, aurinkopyörä, planeettapyörät, kehäpyörä, lukkorenkaat

T20082

- APL 325
- Case 485, 585, 395, 495, 595

T20083

- APL 330
- Case 485, 585, 685, 785, 885, 985, 743, 844, 845, 856, 595, 695, 795, 895, 995

T20084

- APL 335
- Case 685, 785, 885, 985, 743, 844, 745, 856, 995, 895, 795, 695

T20089

- APL 345
- Case 956, 1056

E1.25

08.05.2009



T2086



T2087



T2088



T2089



T2090



T2091

TRAKTORI-MALLI	ETU-AKSELIN PULTTI	MUTTERI	PUSLA-SARJA		OHJAUS-SYLINTERIN PUSLA	OHJAUS-VÄÄNTIÖN PUSLA	ETU-AKSELIN KESKI-TAPIN PUSLA
			A	B			
454	T2086 405584R2	T2087 405576R1	T2088		T2089 379748R2	T2090 1536870C1	T2091 405570R1
474, 475	T2086 405584R2	T2087 405576R1	T2088		T2089 379748R2	T2090 1536870C1	T2091 405570R1
574, 674	T2086 405584R2	T2087 405576R1	T2088		T2089 379748R2	T2090 1536870C1	T2091 405570R1
484, 584	T2086 405584R2	T2087 405576R1	T2088		T2089 379748R2	T2090 1536870C1	T2091 405570R1
684, 784			T2088		T2089 379748R2	T2090 1536870C1	T2091 405570R1
884			T2088		T2089 379748R2	T2090 1536870C1	T2091 405570R1
385, 485, 585, 485XL, 585XL	T2086 405584R2	T2087 405576R1	T2088		T2089 379748R2	T2090 1536870C1	T2091 405570R1
685, 785, 885, 685XL, 785XL, 885XL			T2088		T2089 379748R2	T2090 1536870C1	T2091 405570R1
523, 624		T2069 933948R1					

Sarja A sisältää: 1 x B, 2 x C, 2 x D

OHJAUSSYLINTERI

T20116

188842A1, 549667R93

- 238, 248, 258, 268, 288, 3210, 3220, 3230, 385, 395, 395XL, 4210, 4220, 4230, 4240, 454, 474, 475, 484, 485, 485XL, 495, 495XL, 574, 584, 585, 585XL, 595, 595XL, 674, 684, 685, 685XL, 695, 695XL, 784, 785, 785XL, 795, 84 Hydro, 85 Hydro, 884, 885, 885XL, 895, 895XL, 995XL, CX100, CX50, CX60, CX70, CX80, CX90, MX100C, MX80C, MX90 C

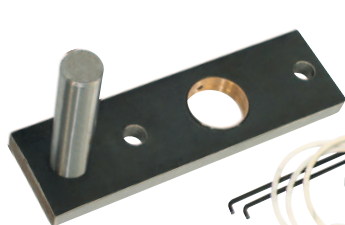

T2275



T2281

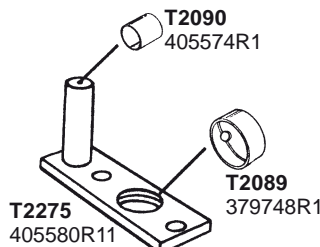

T2090
405574R1

T2089
379748R1

T2275
405580R11

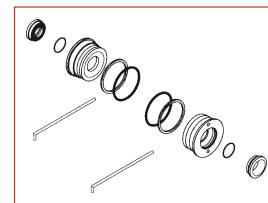

TRAKTORI-MALLI

OHJAUSVÄÄNTIÖN ALALEVY

OHJAUSSYLINTERIN TIIVISTESARJA

Englantilaiset takavetomallit

238, 248, 258, 268, 288, 454, 474, 475, 574, 674, 484, 584, 684, 784, 884, 385, 485, 485XL, 585, 585XL, 685, 685XL, 785, 785XL, 885, 885XL, 395, 495, 495XL, 595, 595XL, 695, 695XL, 795, 795XL, 895, 895XL, 995XL, 3210, 3220, 3230, 4210, 4220, 4230, 4240, 84 Hydro

T2275
405580R11

T2281
55355C91

02.03.2007



TRAKTORI-MALLI	9. SIVURAIDE-TANGON PÄÄ ETU	8. SIVURAIDE-TANGON PÄÄ TAKA	10. RAIDETANGON PÄÄ LOVILLA	11. RAIDETANGON PÄÄ KIERTEELLÄ
250, 275, 276, 354, 374, 384, 414, 434, 444	V1472 3045309R91	V1473 3040922R92	V1470 37H7293	V1471 3040920R92
433, 533, 633 ilman tehostinta		T2125 3147510R1		T2131 3148926R1

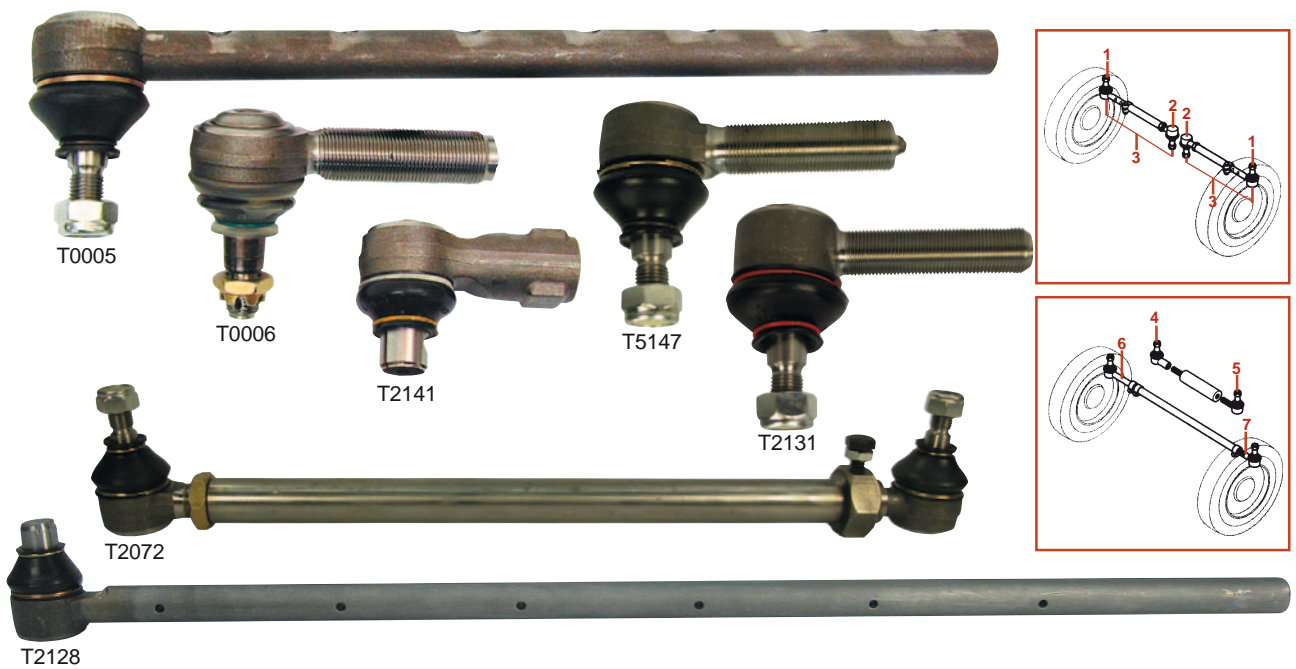

TRAKTORI-MALLI	1.	2.	3.	4.	5.	6.	7.
385, 454, 474, 475, 484, 485, 574, 584, 585, 674	T0005 3116406R3	T0006 3116407R3	T2072 3116321R93				
684, 685, 784, 785, 884, 885	T0005 3125171R1	T0006 3116407R3	T2072				
433, 533, 633, 733 tehostimella				T2141 (b) 314153R93	T5147 3141530R91	T2128 3217563R1	T2131 3148926R1
644, 744, 844 (→005275), 844S (→010500) tehostimella				T2141 (b) 31241532R93	T5147 3141530R91	T2128 3217563R1	T2131 3148926R1
924, 946, 1046, 1246				T2141 (b) 314153R93	T5147 3141530R91		
955 (→001422), 956, 1055 (→001484), 1056							T2131 3148926R1
955, 1055 (001423→)				T2139 3221270R91	T2143 3221271R92		

b - "kartion" halk. T2141 20 mm

E1.27

26.09.2011

TRAKTORI-MALLI	8.	9.	10.
433 (→002918), 533 (→003405), 633 (→003668), 733	T2313 3141531R91	T2312 3141529R91	
454, 474, 475, 484, 485, 574, 584, 585, 674, 784, 785, 884, 885			T2312 3141529R91
644, 744, 844, 844S, 856	T2314 3146035R92	T2312 3141529R91	
946, 1046 (→1518)	T2313 3141531R91	T2312 3141529R91	
946, 1046 (1519→)	T2314 3146035R92	T2312 3141529R91	T2390 3134240R91
955, 956, 1055, 1056	T2143 3221271R92	T2139 3221270R91	T2390 3134240R91
745			T5145 (oik.) K260254

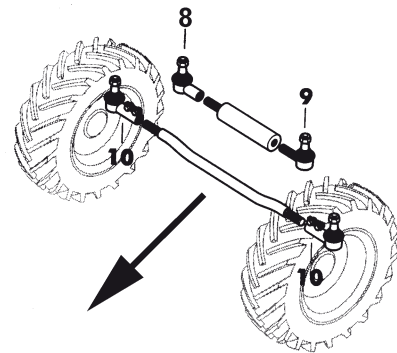

TRAKTORI-MALLI	AKSELI-TYYPPI	1. RAIDETANGON PÄÄT		2. RAIDETANGON PÄÄT	
		VASEN ULOMPI	OIKEA ULOMPI	VASEN SISEMPI	OIKEA SISEMPI
238, 248, 258, 268, 288, 395, 495, 495XL, 595, 595XL, 695, 695XL, 795, 795XL, 895, 995, 995XL, 3210, 3220, 3230, 4210, 4220, 4230, 4240, C50, C60, C70, C80, C90, MX80C, MX90C, MX100C	CARRARO 707	F0662 137047A1	F0663 137048A1	F3957148 1966127C1	VPJ3155 1966125C1
CX50, CX60, CX70, CX80, CX90, CX100	CARRARO 707	F0663 137048A1		VPJ3155 1966125C1	
MX80C, MX90C, MX100C, MX100, MX110, MX120, MX135, MX150, MX170	CARRARO 709	VPJ3176 247523A1		T2414 N14377	
MAXXUM 5120, 5130, 5140, 5150, 5220, 5230, 5240, 5250	CARRARO 709	T2412 126144A1	T2413 126145A1	T2415 N14388	T2414 N14377
685, 785, 885, 743, 744, 745	ZF APL330, 335 keskikardaani	T2411 1968464C1		F3957098 1968468C1	
695, 795, 895, 995, 844, 845	ZF APL330, 335 keskikardaani	T2411 1968464C1		F3957098 1968468C1	
950, 1056	ZF APL345 keskikardaani			F3957098 1968468C1	
CS78, CS86, CS94		T2997 133743601	T2433 133743603	T2435 112509A1	
CS110, CS120, CS130, CS150	CARRARO 715	T2436 (a) 133743611	T2437 (a) 133743614	T2438 (c) 133743613	
CS110, CS120, CS130, CS150	CARRARO 709 HD	T2439 (b) 133743617		T2438 (c) 133743613	

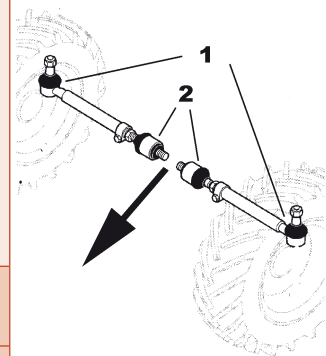

a - 240 mm pitkä

b - 280 mm pitkä

c - 210 mm pitkä

ETUAKSELIN OSIA

TRAKTORI-MALLI	AKSELI-TYYPPI	OLKA-TAPPI
485, 495, 585, 595 (+XL)	ZF APL325	F3946561 81428C1
485, 585, 685, 785, 885, 985, 743, 845, 844S, 844, 595, 695, 795, 895, 995 (+XL)	ZF APL330	F3946561 81428C1
956, 1056 (+XL)	ZF APL345	F0592 81670C1
533, 633, 733, 833	ZF APL1251	F0593 3216588R1
585, 685, 785, 885, 743, 644, 744, 844, 844S, (+XL)	ZF APL1351	F0593 3216588R1



F3946561

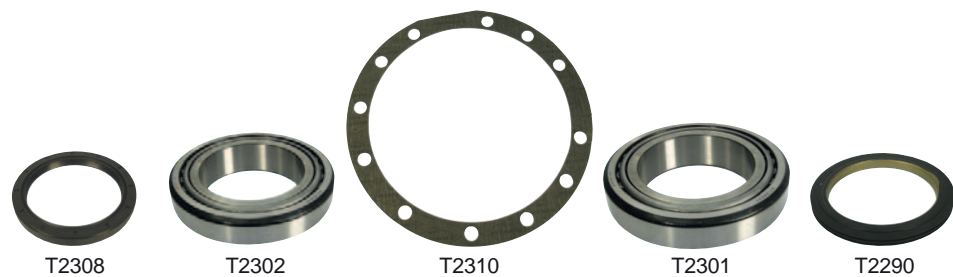

TRAKTORI-MALLI	SISEMPI TIIVISTE	SISEMPI LAAKERI	VETOAKSELIN PUTKEN-TIIVISTE	ULOMPI LAAKERI	ULOMPI TIIVISTE
275, 276				L6213-2RS 3114947R91	T2288 3069987R91
414, 434, 444				L6213-2RS 3114947R91	T2288 3069987R91
454, 484, 485			T2310 399762R3		
474, 475, 574, 584, 585	T2308 530102R91	T2302 972467R91	T2310 399762R3	T2301 384695R91	T2290 105471C1
674, 684, 685, 784, 785, 884, 885	T2308 530102R91	T2302 972467R91	T2310 399762R3	T2301 384695R91	T2290 105471C1
423, 433, 453, 533, 633				L6213-2RS 3114947R91	T2291 (a) 713172R1 T2292 (b) 711199R1
544, 743, 745, 644, 744, 844, 844S, 845, 856		L6214-2RS ST273A		L6215-2RS 712794R91	T2293 3145061R91
946, 1046		L30217 3134990R91		L30217 3134990R91	
955, 1055, 946, 1056		L6215-2RS		L6216-2RS 3220034R93	T2294 3220032R91

a - huopa
b - stefä

04.02.2008

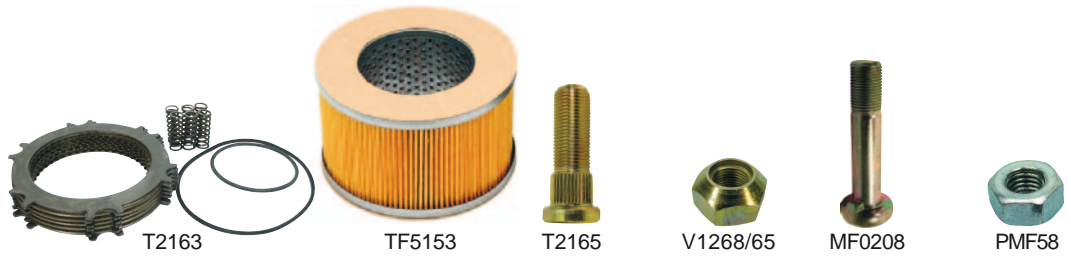

TRAKTORI-MALLI	PIKA-VAIHTEEN KORJAUS-SARJA	VOIMAN ULOSOTTO-KYTKIMEN KORJAUS-SARJA	HYDRAULI-SUODATIN	TAKA-PYÖRÄN PULTTI	TAKA-PYÖRÄN MUTTERI	TAKA-VANTEEN KEHÄ-PULTTI	KEHÄ-PULTIN MUTTERI
250, 275, 276, 414, 444						MF0208 K611261	PMF58
454	T2161 534936R93		TF5153 (c) 65126C92	T2165 404341R4	V1268/65 3047575R2	MF0553 K611270	PMF58
474, 475, 574	T2161 534936R93	T2162 (d) 534934R1	TF5153 (c) 65126C92	T2165 404341R4	V1268/65 3047575R2	MF0553 K611270	PMF58
674	T2161 534936R93	T2163 (d) 66193C91	TF5153 (c) 65126C92	T2165 404341R4	V1268/65 3047575R2	MF0553 K611270	PMF58
484	T2161 534936R93	T2163 (d) 66193C91	TF5153 (c) 65126C92	T2165 404341R4	V1268/65 3047575R2	MF0553 K611270	PMF58
584, 684	T2161 534936R93	T2163 (d) 66193C91	TF5153 (c) 65126C92	T2165 404341R4	V1268/65 3047575R2	MF0553 K611270	PMF58
784	T2161 534936R93	T2163 (d) 66193C91	TF5153 (c) 65126C92	T2165 404341R4	V1268/65 3047575R2	MF0553 K611270	PMF58
485, 585	T2161 534936R93	T2163 (d) 66193C91	TF5153 (c) 65126C92	T2165 404341R4	V1268/65 3047575R2	MF0553 K611270	PMF58
685, 785	T2161 534936R93	T2163 (d) 66193C91	TF5153 (c) 65126C92	T2165 404341R4	V1268/65 3047575R2	MF0553 K611270	PMF58
844, 885	T2161 534936R93		TF5153 (c) 65126C92	T2165 404341R4	V1268/65 3047575R2	MF0553 K611270	PMF58
523, 624			TF5184 (b) 3147441R92 T2164A (b) 1328276C1				
433, 533, 633, 733			TF5184 (b) 3147441R92 T2164A (b) 1328276C1	T2167 3399467R1	T2171 98782C1 T2172 (a) 3230348R2		
856, 844			TF5184 (b) 3147441R92 T2164A (b) 1328276C1	T2167 3399467R1	T2171 98782C1 T2172 (a) 3230348R2		
955, 1055			TF5184 (b) 3147441R92 T2164A (b) 1328276C1	T2168 3220372R2	T2173 98783C1		
956, 1056			TF5184 (b) 3147441R92 T2164A (b) 1328276C1	T2168 3220372R2	T2173 98783C1		

a - kartioprikka

b - **TF5184** korkeus 71 mm, **T2164A** korkeus 120 mm

c - saatavana myös HD suodatinta **DFP550128**

d - **T2162** = 4 kitkalevyä + 6 teräslevyä (teräslevyissä 4 sakaraa)

T2163 = 5 kitkalevyä + 8 teräslevyä (teräslevyissä 6 sakaraa)

E1.30



VO-AKSELI

T2427

1500087C1

- 238, 248, 258, 268, 278, 288, 385, 395, 484, 485, 495, 584, 585, 595, 684, 685, 695, 784, 785, 795, 884, 885, 895, 485XL, 495XL, 585XL, 685XL, 695XL, 785XL, 795XL, 885XL, 895XL, 995XL, 85 Hydro, 3210, 3220, 3230, 4210, 4220, 4230, 4240, C50, C60, C80, C90, CX50, CX60, CX80, CX90, CX100



VO-AKSELI

T20086

226823A1

- Maxxum 5120, 5130, 5140, 5150, MX80C, MX90C, MX100C, MX100, MX110, MX120, MX135, MX150, MX170



VO-AKSELI

T2460

3402751R1

- 844XL, 856XL, 956, 956XL, 1056, 1056XL

KYTKIN- JA VO-VAIJERI

T20125

3234644R1, 3404859R1

- 743, 745, 844, 845, 856, 955, 956, 1055, 1056

KÄYTTÖAKSELIT

- 238, 248, 258, 395, 495, 595, 248, 258, 385, 485, 585 (1591→), 268, 288, 695, 795, 895, 495XL, 685, 785, 885, 685XL, 695XL, 785XL, 795XL, 885XL, 895XL, 995XL, 856XL
- 21-urainen
- Ø 30 mm
- akselityyppi APL330
- sopiva laakeri LEW206



T20091

1335030C1

- 1550 mm pitkä

T20121

1335030C1

- 1495 mm pitkä

NELIVEDON KÄYTTÖAKSELIN URAHOLKIT



T2428

90031C2

- 238, 248, 258, 395, 495, 595, 248, 258, 385, 485, 585 (1591→), 268, 288, 695, 795, 895, 495XL, 685, 785, 885, 685XL, 695XL, 785XL, 795XL, 885XL, 895XL, 995XL, 743, 745S, 844S, 845, 743XL, 745XL, 844XL, 845XL, 856XL
- 21-urainen
- 30 mm
- akselityyppi APL330

T2429

90030C2

- 238, 248, 258, 395, 495, 595, 248, 258, 385, 485, 585 (1591→), 268, 288, 695, 795, 895, 495XL, 685, 785, 885, 685XL, 695XL, 785XL, 795XL, 885XL, 895XL, 995XL, 743, 745S, 844S, 845, 743XL, 745XL, 844XL, 845XL, 856XL, 956, 956XL, 1056XL
- 24-urainen
- 32 mm
- akselityyppi APL335



PULTTI

T2428A

90088C1

- 238, 248, 258, 268, 288, 395, 485, 495XL, 585, 595XL, 685(XL), 695(XL), 743(XL), 745S, 745XL, 785(XL), 795XL, 844S, 844XL, 845(XL), 856XL, 885(XL), 895(XL), 956(XL), 995XL, 1056(XL), 485XL, 585XL (→734/APL330)



KANNATIN

T2695

1537682C1

- 238, 248, 258, 268, 288, 395, 495XL, 595XL, 695(XL), 743, 743(XL), 745S, 745XL, 795XL, 844S, 845XL, 856XL, 895, 956(XL), 995XL, 1056(XL), 3220, 3230, 4210, 4220, 4230, 4240



LAAKERIT

T2696

1537681C1

- 238, 248, 258, 268, 288, 395, 485(XL), 495XL, 585(XL), 595XL, 685(XL), 695(XL), 743(XL), 745S, 745XL, 785(XL), 795XL, 844S, 844(XL), 845XL, 856XL, 885(XL), 895, 956(XL), 995XL, 1056(XL), 3210, 3220, 3230, 4210, 4220, 4230, 4240
- sisähalkaisija 32 mm
- ulkohalkaisija 62 mm

L16206

- sisähalkaisija 30 mm
- ulkohalkaisija 62 mm

26.09.2011

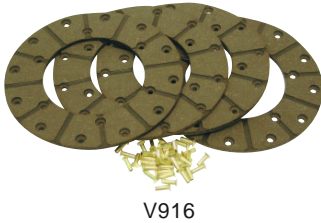

V916



T2100



T2102



T2105

T2106

TRAKTORI-MALLI	JARRUJEN KOKO	JARRULEVY-SARJA	JARRULEVY TÄYDELLINEN	KÄSIJARRU PANTA/HIHNA	KÄSIJARRU-VAIJERI	JARRUN TYÖ-SYLINTERI
250, 275, 414	140 mm	T0008 (c) 3134668R3				
275, 276, 354, 374, 384, 414, 434, 444	165 mm	V913L 3040152R92				
454, 474, 475, 574, 674				T2102 1971050C1	T2105 (b) 3129788R2	
385, 484, 485, 584, 585, 684, 685, 784, 785, 884, 885				T2102 1971050C1	T2106 (b) 1500021C1	
523, 624, 724, 824	178 mm	V916 3069460R91	T2098			
433, 533, 633	165 mm	V913L 3040152R92				
856, 745, 844			T2101 3145546R91	T2103 (a) 3145546R92		
955, 956, 1055, 1056			T2100 3220450R91			
1255XL, 1455XL						T2675 3401367R1

a - hihna b - pituus: **T2105** 420 mm, **T2106** 890 mm
c -sis.4 jarrulevyä +niitit (24 kpl)

JARRULEVY

T20114

114622C1, 114622C2
- 2 kpl/traktori
- 238, 248, 258, 268, 288, 3210, 3220, 3230, 385, 395, 395XL, 4210, 4220, 4230, 454, 474, 475, 484, 485, 485XL, 495, 495XL, 574, 584, 585, 585XL, 595, 595XL, 674, 684, 685, 685XL, 695, 695XL, 784, 785, 785XL, 795, 884, 885, 885XL, 895, 895XL, 995XL, CX100, CX50, CX60, CX70, CX80, CX90

VÄLIJARRULEVY

T20115

399736R3
- 2 kpl/traktori
- 238, 248, 258, 268, 288, 3210, 3220, 3230, 385, 395, 395XL, 4210, 4220, 4230, 4240, 454, 474, 475, 484, 485, 485XL, 495, 495XL, 574, 584, 585, 585XL, 595, 595XL, 674, 684, 685, 685XL, 695, 695XL, 784, 785, 785XL, 795, 884, 885, 885XL, 895, 895XL, 995XL, CX100, CX50, CX60, CX70, CX80, CX90

JARRUN TIIVISTESARJA

T2402

539535R91
- 238, 248, 258, 268, 288, 454, 474, 475, 574, 674, 484, 584, 684, 784, 884, 385, 485, 485XL, 585, 585XL, 685, 685XL, 785, 785XL, 885, 885XL, 985XL, 395, 495, 495XL, 595, 595XL, 695, 695XL, 795, 795XL, 895, 895XL, 995XL, 3210 (JJE0908036), 3220 (JJE 0908036), 3230 (JJE 0908036), 4210 (JJE 0908036), 4220 (JJE 0908036), 4230 (JJE 0908036), 4240 (JJE 0908036), 84 Hydro
- 2 x 21472R1, 2 x 289506R1, 2 x 238-6274

PÄÄSYLINTERIN KORJAUSSARJA

VPJ7276

3125824R1
- 385, 454, 474, 475, 484, 485, 574, 584, 585, 674, 684, 685, 784, 785, 884, 885

JARRU-MÄNTÄ

T2669
3223252R7



VÄLI-LEVY

T2670
3145548R2
- ulko Ø 239 mm
- sisä Ø 135 mm
- vahvuus 13 mm



- 743, 743XL, 745S, 745XL, 844S, 844XL, 845, 845XL, 856XL

O-RENGAS

T2671
3230853R1

T2672
3230854R1

- 743, 743XL, 745S, 745XL, 844S, 844XL, 845, 845XL, 856XL, 955, 955XL, 956, 956XL, 1055, 1055XL, 1056, 1056XL

YKSÖISPUMPUT



T0007

704330R95

- 250, 275, 276, 354, 374, 384, 414, 434, 444



T2339

- 3145248R93, 3142097R91
0.510.415.311, 0.510.415.301
0.510.415.303, 0.510.415.306
0.510.410.315
- 353, 383, 423



T2278

93835C92
- 238, 248, 258, 268, 288, 3210, 3220, 3230, 385, 395, 395XL, 4210, 4220, 4230, 4240, 454, 474, 475, 484, 485, 485XL, 495, 495XL, 574, 584, 585, 585XL, 595, 595XL, 674, 684, 685, 685XL, 695, 695XL, 784, 785, 785XL, 795, 84 Hydro, 85 Hydro, 884, 885, 885XL, 895, 895XL, 995XL, CX100, CX50, CX60, CX70, CX80, CX90

KAKSOISPUMPUT



T2318

3147535R94, 3216613R91,
0.510.465.349, 0.510.465.321,
0.510.465.338, 0.510.465.302
- Hydr.ZF, 533, 433, 633, 644, 645, 733,
743, 744, 745, 745S, 833, 844, 844S,
845, 856
- ensimmäisessä pumpussa imu- ja
paineliitäntä
- kaksi naarasliitäntää päädyssä
- tuotto 8/8 cm³



T2319

3220221R93
0.510.565.321, 0.510.565.362,
0.510.565.396
- 956XL, 1056XL Sens-O-draulic
- ensimmäisessä pumpussa imu- ja
paineliitäntä
- kaksi naarasliitäntää päädyssä
- tuotto 11/8 cm³



T2320

3401189R94
0.510.465.332, 0.510.465.339
- 743XL, 745XL, 844XL, 845XL, 856XL
Sens-O-draulic
- ensimmäisessä pumpussa
paineliitäntä, toisessa pumpussa
imuliitäntä
- kaksi naarasliitäntää päädyssä
- varustettu ylipaineventtiilillä
- tuotto 8/8 cm³



T2323

89880C91
0.510.565.365
- 956XLA, 1056XLA
- ensimmäisessä pumpussa imu- ja
paineliitäntä, toisessa pumpussa
imuliitäntä
- kaksi naarasliitäntää päädyssä
- tuotto 11/8 cm³



VPK0101

3223932R94
0.510.565.330, 0.510.565.361,
0.510.565.395
- 955, 955XL, 956, 956XL
- ensimmäisessä pumpussa imu- ja
paineliitäntä
- kaksi naarasliitäntää päädyssä
- tuotto 11/8 cm³

VETOVARSIEN TUNNISTELIJA-AKSELI



T2665

3225611R1
- 743XL, 745XL, 844XL, 845XL, 856XL
- tiivistesarja **T2666**
- tarvitaan 1 kpl/sivu

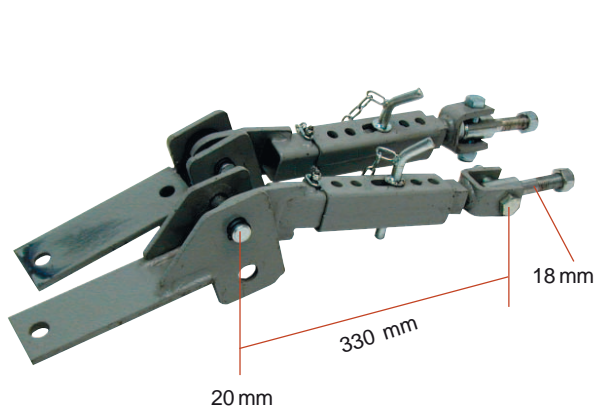

SIVURAJOITINPARI

T0179

- IH250, 275, 276, 414, 434, 444
- sisäosa 30 x 30 mm
- sokkatappi 12 mm

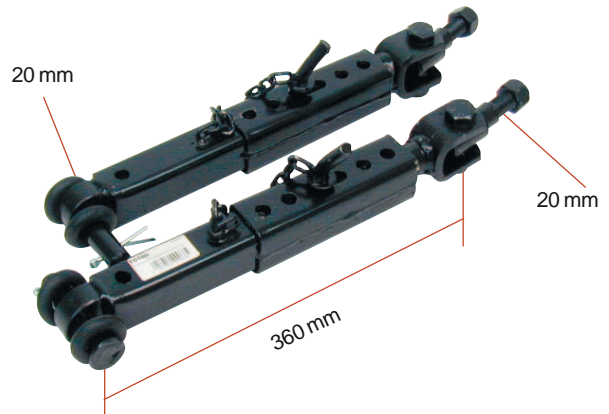

SIVURAJOITINPARI

T0180

- IH474, 574, 674, Volvo 500
- sisäosa 30 x 30 mm
- sokkatappi 12 mm

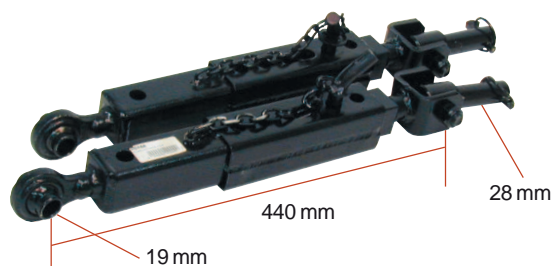

SIVURAJOITINPARI

T0188

- IH845
- sisäosa 40 x 40 mm
- sokkatappi 16 mm

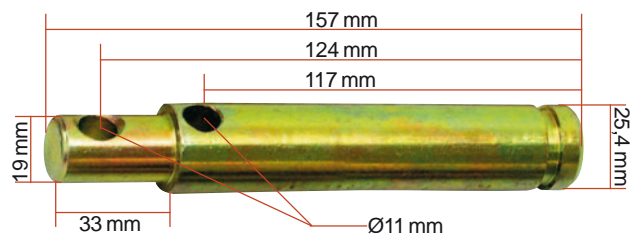

TYÖNTÖVARREN TAPPI

T0078

- 528084R1, 3074756R1
- IH mallit 248, 258, 268, 278, 385, 454, 464, 474, 475, 484, 485, 485XL, 574, 584, 585, 674, 684, 685, 784, 785, 884, 885, 2400, 2500, H84



SÄÄTÖKAMPI

F0527

- 250, 275, 276, 354, 384, 414, 434, 444

Vasen yläosa

T2344

- pituus 356 mm

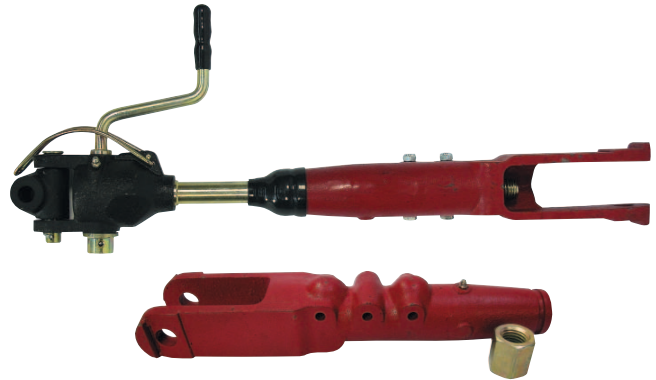

SÄÄTÖKAMPI

T2343

- 385, 454, 474, 475, 484, 485, 485XL, 495, 495XL, 574, 584, 585, 585XL, 595, 595XL, 674, 684, 685, 685XL, 695, 695XL, 784, 785, 785XL, 795, 884, 885, 885XL, 895, 895XL

Alaosa

T2346

Vasen yläosa

T2345

- pituus 467 mm



min työpituus 500 mm
iskupituus 180 mm

alareikä
Ø 26 mm

ylänivel Ø 20 mm,
tehty 25,4 mm puslalla

HYDRAULINEN SÄÄTÖKAMPI

T1721

- Case 120MX
- mäntä 80 mm
- varsi 40 mm



min työpituus 920 mm
iskupituus 190 mm

alareikä
Ø 30 mm

ylänivel Ø 28 mm
haarukan väli 43 mm

HYDRAULINEN SÄÄTÖKAMPI

T1723

- Case 150MX
- mäntä 90 mm
- varsi 45 mm

04.03.2011



ETU-UMPIO suorakaide H4

T2360

1333291C1

- 1056XL, 1255, 1255XL, 1394, 1455, 1455XL, 433, 433E, 433V, 533, 533E, 533V, 633, 633E, 633V, 733, 733E, 743, 743XL, 745S, 745XL, 833, 833E, 844S, 844XL, 845, 845XL, 856XL, 956, 956XL
- 163 x 104 mm
- sopiva polttimo **P12342**



ETU-UMPIO neliönmuotoinen

T2391

3404170R94

- 383, 423, 433, 453, 533, 553, 633, 644, 724, 733, 743, 744, 745, 824, 833, 844, 856, 946, 955, 956, 1046, 1055, 1056, 1246
- sopiva polttimo **P12620**

ETULYHTY

ST0099

- B250, B275, B414, B444



ETULYHTY

T20120

3129035R1, 5964600

- 485, 485XL, 585, 585XL, 685, 685XL, 784, 785, 785XL, 884, 885, 885XL



VILKKU-ÄÄRIVALO ETEEN

- 1055, 1055XL, 1056, 1056XL, 1255, 1255XL, 1455, 1455XL, 3210, 3220, 3230, 4210, 4220, 4230, 4240, 433, 440, 485XL, 533, 585XL, 633, 640, 644, 685XL, 733, 740, 743, 743XL, 744, 745S, 745XL, 785XL, 833, 840, 844, 844S, 844XL, 856XL, 885XL, 940, 955, 955XL, 956, 956XL
- sopivat polttimet 1 x **P12498** ja 1 x **P12814**

Vasen T2372

3226119R1

Oikea T2373

3226120R1



VILKKU-ÄÄRIVALO ETEEN

T2376

3121089R91

- 433, 533, 633, 733, 833, 933, 743, 644, 744, 844, 645, 745, 845, 955, 1055, 1255, 1455
- sopivat polttimet 1x **P12498** ja 1 x **P12814**
- varalasi **T2377**



VILKKU-ÄÄRIVALO ETEEN

T2370

ET420

- 644, 743, 745, 844, 856, 956, 1056, 1255, 1455, XL-sarja
- sopivat polttimet 1x **P12498** ja 1x **P12821**

ÄÄRIVALO/TAKAVALO

MF0663

- 250, 275, 276, 414, 434

- varalasi punainen **MF0664**
- varalasi valkoinen **MF0665**
- kumitiiviste **MF0666**



TAKAVALOT

- 1046, 1055XL, 1246, 485XL, 585XL, 644, 685XL, 743, 744, 745S, 785XL, 844, 844S, 845, 885XL, 946, 955XL
- sopivat polttimet 1 x **P12814** ja 2 x **P12498**

Vasen F1941207

3145942R91

- varalasi **F1941210**

Oikea F1941208

3145943R91

- varalasi **F1941209**



TAKAVALOT

- 1046, 1055, 1056, 1056XL, 1246, 1255, 1255XL, 1455, 1455XL, 433, 440, 485XL, 495XL, 533, 585XL, 595XL, 633, 640, 685XL, 695XL, 733, 740, 743XL, 745XL, 785XL, 795XL, 833, 840, 844XL, 845XL, 856XL, 885XL, 895XL, 940, 946, 955, 956, 956XL, 995XL
- sopivat polttimet 1 x **P12814** ja 2 x **P12498**

Vasen T2384

3223263R91

- varalasi **T2386**

Oikea T2385

3223264R91

- varalasi **T2387**



TAKAVALOT

- 1046, 1055, 1055XL, 1056, 1056XL, 1246, 1255, 1255XL, 1455, 1455XL, 3220, 3230, 4210, 4220, 4230, 4240, 644, 743, 743XL, 744, 745S, 745XL, 844, 844S, 844XL, 856XL, 946, 955, 955XL, 956, 956XL
- sopivat polttimet 2 x **P12498** ja 2 x **P12844**

Vasen T2380

3221209R92

- varalasi **T2382**

Oikea T2381

3221210R92

- varalasi **T2383**

E1.37

21.09.2009

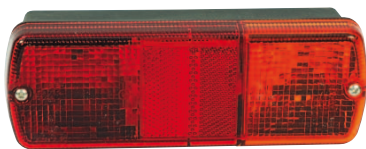

TAKAVALO

T20108

177239A2, 259816A1
- CX50, CX70, CX80, CX90, CX100, MX100, MX110, MX120, MX135, MX150, MX170



VILKKU-/ÄÄRIVALOT

224621A2

- Sopii: 5120-5150, CX50-CX100, MX100-MX170

Vasen
T20107

Oikea
T20106



TYÖVALOT H3

1-40-172-212

- CS100, CS110, CS120, CS130, CS150, CS78, CS86, CS94
- sisältää polttimon

Vasen
ST0360

Oikea
ST0361



ETUMASKI

T20092

3121652R1
- Case IH 238, 248, 258, 384, 385, 484, 485, 485XL, 584, 585, 585XL, 685XL, 785XL, 885XL

YLEMPI ETUMASKI

T20093

3121663R1
- Case IH 238, 248, 268, 278, 384, 385, 484, 485, 485XL, 584, 585XL, 684, 685, 685XL, 784, 785, 785XL, 884, 885, 885XL, H84

MERKKI KEULAAN

T20094

120397C1
- Case IH 1055, 1055XL, 1056, 1056XL, 1086, 1400, 1486, 1586, 238, 248, 258, 268, 274, 278, 284, 3388, 3588, 3788, 384, 385, 433, 4366, 4386, 4568, 4586, 4786, 484, 485, 485XL, 533, 584, 585, 585XL, 633, 644, 684, 685, 685XL, 733, 743, 743XL, 744, 745S, 745XL, 782, 784, 785, 785XL, 786, 833, 844, 844S, 844XL, 856XL, 884, 885, 885XL, 886, 955, 955XL, 956, 956XL, 986, H84, HYDRO 186



YLEMPI ETUMASKI

T20081

8402639R91
- Case IH 644, 844, 844S, 844XL, 856XL, 946, 955, 955XL, 956, 956XL, 1046, 1055, 1055XL, 1056, 1056XL, 1246

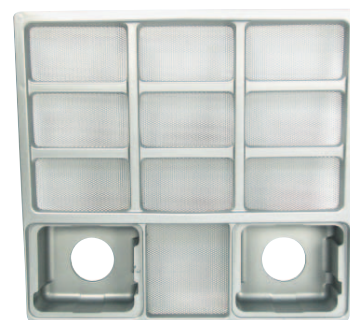

MERKKI KEULAAN

T20117

1333266C1
- 248, 258, 385, 433, 485, 533, 585, 585XL, 633, 685, 733, 743, 743XL, 744, 745, 745S, 745XL, 785, 785XL, 844XL, 845, 845XL, 856, 856XL, 885, 885XL, 956, 956XL, 1056, 1056XL, 1255, 1255XL, 1455, 1455XL



ETUMASKI

T20080

3141785R92
- Case IH 644, 844, 844S, 844XL, 856XL, 946, 955, 955XL, 956, 956XL, 1046, 1055, 1055XL, 1056, 1056XL, 1246

22.10.2010



TRAKTORIMALLI	ETUSULKA	PEILI
248, 258, 268, 278, 2300A, 2400A, 3434 teollisuus, 354, 454, 574, 674, 384, 484, 584, 684, 743, 745S, 784, 844S, 845, 1246	VLC3223 3113077R1	
248, 258, 385, 485, 585, 685, 785, 884, 885	VLC3225 3113942R1	
485XL, 585XL, 685XL, 695XL, 743XL, 745XL, 785XL, 795XL, 844XL, 845XL, 856XL, 885XL, 895XL, 955XL, 956XL, 1055XL, 1056XL	VLC3228 3234746R91	T1528 3399576R91
Maxxum-sarja 5120, 5130, 5140, 5150	VLC3229 10/3229	T2419 297017A1
3210, 3220, 3230, 4210, 4220, 4230, 4240, 5120, 5130, 5140, 5150, CX100, CX50, CX60, CX70, CX80, CX90, MX100, MX100C, MX110, MX120, MX135, MX150, MX155, MX170, MX180, MX200, MX220, MX240, MX270, MX80C, MX90C, MXM120, MXM130, MXM140, MXM155, MXM175, MXM190, MXU100, MXU110, MXU115, MXU125, MXU130, MXU135		T2419 297017A1
Magnum sarja 7110, 7120, 7130, 7140	VLC3225 3113942R1	



TRAKTORI-MALLI	OHJAAMO-TYYPPI	TAKALASIN SYLINTERI	KATTO-LUUKUN SYLINTERI	OVI-SYLINTERI	KONEPEITON SYLINTERI
485XL, 585XL, 685XL, 743XL, 745XL, 785XL, 844XL, 845XL, 856XL, 885XL, 955XL, 956XL, 1055XL, 1056XL, 1255XL, 1455XL	XL ohjaamo	T2335 KS0110 3234163R1	T2336 KS0111 3399422R3	T2337 KS0112 3232937R1	
484, 584, 684, 784, 884	Sekura ohj.	T4186 KS0116 K302896			
Maxxum 5120, 5130, 5140, 5150		VPM1704 KS0147 1971235C2	T2336 KS0111 3399422R3		T2668 (a) 108157A1 VPM1711 (b) KS0149
Magnum 7130, 7140				VPM1674 KS0140 91853C1	
CS78, CS86, CS96, CS110, CS120, CS130, CS150		T20016 199976066			T2667 1-99-976-061
CVX120, CVX130, CVX150, CVX170					T2667 1-99-976-061
CX50, CX60, CX70, CX80, CX90, CX100, MX80C, MX90C, MX100C, MX100, MX110, MX120, MX135, MX150, MX170		T20017 189447A2			

a - pituus 227 mm
b - pituus 355 mm

E1.39

Alkuperäisnumerot ovat ainoastaan vertailua varten, eivätkä tarkoita, että tuotteet ovat alkuperäisiä. Tavukoissa esiintyvät kuvat ovat viitteellisiä.

26.09.2011



LÄMMITYSLAITTEEN MOOTTORI

ST0145

- vanhemmat ohjaamot, Smith:
453, 533, 454, 474, 475, 574, 674

LÄMMITYSLAITTEEN MOOTTORI

T2321

- sekura ohjaamo, Bosch,
Comfort 2000 -ohjaamo: 644, 743,
744, 745S, 844, 844S, 946, 955,
1046, 1055, 1246

LÄMMITYSLAITTEEN MOOTTORI

T2324

1974779C1
- XL-ohjaamo, Bosch: 495XL, 585,
585XL, 595, 595XL, 685, 695XL,
743XL, 745XL, 795XL, 844XL, 845XL,
856XL, 885, 895XL, 956XL, 955,
955XL, 1056XL, 1255XL, 1455XL,
5120, 5130, 5140, 5150, 7110, 7120,
7130, 7140, 7150

TUNTIMITTARIN / NOPEUSMITTARIN VAIJERIT



T2330



TUOTE- NUMERO	SOPIVUUS
VPM5216 529234R1	248, 258, 268, 278, 385, 484, 485, 584, 585, 684, 685, 784, 785, 884, 885, H84 - pituus 1440 mm, päät eri kokoiset
VPM5217 1500716C1 537494R91	248, 258, 268, 278, 288, 385, 395, 484, 485, 495, 584, 585, 585XL, 595, 684, 685,685XL, 695, 784, 785, 785XL, 795, 884, 885, 885XL, 895, 995, H84, 3210 3220, 3230, 4210,4220, 4230 - pituus 1630 mm, päät eri kokoiset
VPM5226 3399112R91	743XL, 745XL, 844XL, 845XL, 856XL, 745S, 744, 844S, 845, 624, 724, 433, 533, 633, 733, 833, 743, 745, - pituus 1540 mm, päät saman kokoiset
T2330 3058287R94	624, 724, 824, 844, 845, ym., - pituus 1610 mm, päät saman kokoiset
VPM5227 3321164R91 3224532R92 3399100R91	955, 956, 1055, 1056, 955XL, 956XL, 1055XL, 1056XL - pituus 1820 mm, päät saman kokoiset
T2331 3221164R91	955, 1055, 6-syl. - pituus 2520 mm, päät saman kokoiset
MF0679 1970820C1	475 - pituus 1560 mm
T20122 3042465R91	B275, B414
T20123 3042473R91	B275, B414 - pituus 920 mm

OHJAAMON KUMITYYNY ETU

T20073

3399959R1

- XL-ohjaamo: 884XL, 485XL, 585XL, 685XL, 785XL, 885XL,
743XL, 844XL, 745XL, 845XL, 955XL, 1055XL, 1255XL,
1455XL, 856XL, 956XL, 1056XL, 495XL, 595XL, 695XL,
795XL, 895XL, 995XL



OHJAAMON KUMITYYNY TAKA

T20074

3399961R1

- XL-ohjaamo: 884XL, 485XL, 585XL, 685XL, 785XL, 885XL,
743XL, 844XL, 745XL, 845XL, 955XL, 1055XL, 1255XL,
1455XL, 856XL, 956XL, 1056XL, 495XL, 595XL, 695XL,
795XL, 895XL, 995XL

25.07.2008

Sekura-ohjaamo
484, 584, 684, 784, 884

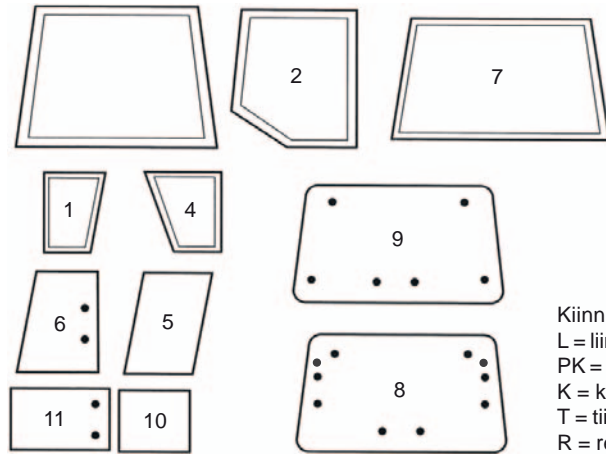

Kiinnitystavat:
L = liimattu
PK = pulttikiinnitys
K = kehyksellä
T = tiivisteellä
R = reunasuojalla

	TUOTE-NRO	LASI	KUVAUS	ALKUPERÄIS- NUMERO	KOKO mm (k ork. x lev. x vahv.)	VÄRI	KIINNITYS
1	T20051	Alempi etu	oik., kehyksellä	K965470	630 x 280	kirkas	K
1	T20052	Alempi etu	vas., kehyksellä	K965469	630 x 280	kirkas	K
2	T20053	Ylempi oven	oik., kehyksellä	K965484	800 x 740	kirkas	K
4	T20055	Alempi oven	vas., kehyksellä	K965485	635 x 490	kirkas	K
4	T20056	Alempi oven	oik., kehyksellä	3125460R1	635 x 490	kirkas	K
5	T20057	Sivulasi	kiinteä, ei avattava		675 x 460 x 5	kirkas	K
6	T20058	Sivulasi	liuku, 2 reikää		670 x 385 x 5	kirkas	K
7	T20059	Ylempi taka	kehyksellä	K965468	1150 x 675	kirkas	K
8	T4213	Ylempi taka	10 reikää	K965668 3125412R1	1175 x 637 x 5	kirkas	R/PK
9	T20060	Alempi taka	kiinteä, ei avattava		478 x 335 x 5	kirkas	K
10	T20061	Alempi taka	liuku, 2 reikää		478 x 330 x 5	kirkas	K

XL-sarja

496, 585, 685,
595, 695, 795,
895, 995, 743/745,
844/845/856, 956,
1056, 1255, 1455

MX-sarja

3220/3230,
4210/4220/4230/4240

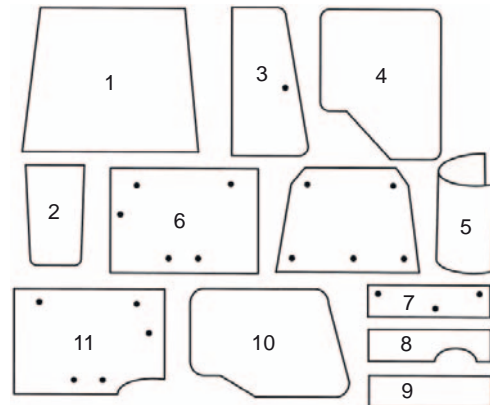

	TUOTE-NRO	LASI	KUVAUS	ALKUPERÄIS- NUMERO	KOKO mm (k ork. x lev. x vahv.)	VÄRI	KIINNITYS
1	T2350	Tuulilasi	kaareva	3233045R2	1217 x 893 x 5	sävytetty	L
2	T20024	Alempi etu	vas., kaareva	3233036R1	522 x 290 x 4	sävytetty	L
2	T20025	Alempi etu	oik., kaareva	3233037R1	522 x 290 x 4	sävytetty	L
3	T2351	Oven etu	vas. & oik., 1 reikä	3233053R1	888 x 277 x 5	sävytetty	L
4	T2352	Oven taka	vas. & oik.	3233051R1	888 x 593 x 5	sävytetty	L
5	T2348	Takakulma	vas., kaareva	3233040R1	643 x 430 x 5	sävytetty	L
5	T2349	Takakulma	oik., kaareva	3233041R2	643 x 430 x 5	sävytetty	L
6	T2334 (a)	Ylempi taka	5 reikää	182027A2	842 x 648 x 5	sävytetty	R/PK
7	T2353 (b)	Alempi taka	3 reikää	182028A1	873 x 305 x 5	kirkas	PK
8	T2353A	Alempi taka	katso kuva	1500941C1	835 x 270 x 5	sävytetty	L
9	T20026	Alempi taka		98041C1	835 x 270 x 5	kirkas	L
10	T20027 (d)	Oven	yksiosainen	1975195C1	890 x 870 x 5	sävytetty	L
11	T2421 (d)	Ylempi taka	katso kuva, 5 reikää	126317A2	842 x 648 x 5	sävytetty	R/PK

a - korvaa alkuperäisnumeron 3233046R4
b - korvaa alkuperäisnumeron 3233032R1X

d - sopii vain 3220, 3230, 4210, 4220, 4230 ja 4240 malleihin

E1.41

Alkuperäisnumerot ovat ainoastaan vertailua varten, eivätkä tarkoita, että tuotteet ovat alkuperäisiä. Taulukoissa esiintyvät kuvat ovat viitteellisiä.

LP-ohjaamo

3210, 3220, 3230, 4210, 4220, 4230, 4240

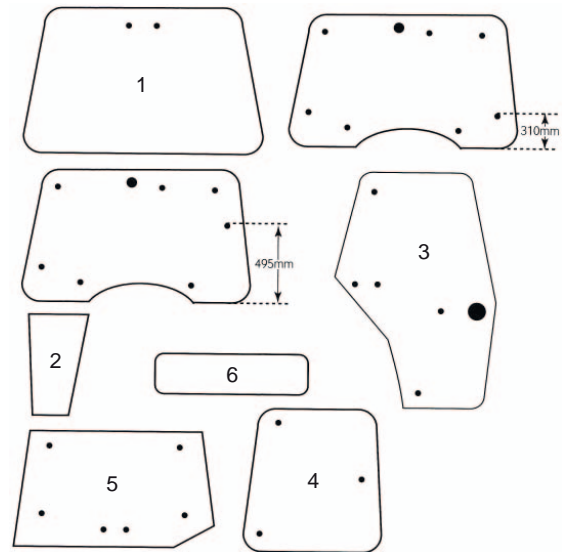

	TUOTE-NRO	LASI	KUVAUS	ALKUPERÄIS- NUMERO	KOKO mm (k ork. x lev. x vahv.)	VÄRI	KIINNITYS
1	T20028	Tuulilasi	kiinteä, ei avattava, 2 reikää	144768A1	1245 x 870 x 5	kirkas	L
2	T20029	Alempi etu	vas. & oik.	144730A1	570 x 300 x 5	kirkas	L
3	T20030	Oven	vas., 6 reikää, kaareva	144950A1	1443 x 900 x 6	kirkas	R/PK
3	T20031	Oven	oik., 6 reikää, kaareva	144969A1	1443 x 900 x 6	kirkas	R/PK
4	T20032	Sivulasi	vas. & oik., 3 reikää	144759A1	715 x 610 x 5	kirkas	R/PK
5	T20033	Ylempi taka	6 reikää	144794A1	1190 x 680 x 5	kirkas	R/PK
6	T20034	Alempi taka		144731A1	473 x 210 x 5	kirkas	L

Kiinnitystavat: L = liimattu
 PK = pulttikiinnitys
 K = kehyksellä
 T = tiivisteellä
 R = reunasuojalla



TUULILASILIIIMASARJA

HK269

- annostellaan kylmänä, valumaton
- max. kiinnitysaika 25 min
- ajovalmuisaika 2 h
- sisältö: puhdistusaine 20 ml, puhdistusliina, primer 10 ml, primer-levitin, liima 310 ml

04.03.2011



Maxxum-sarja
5120, 5130, 5140, 5150

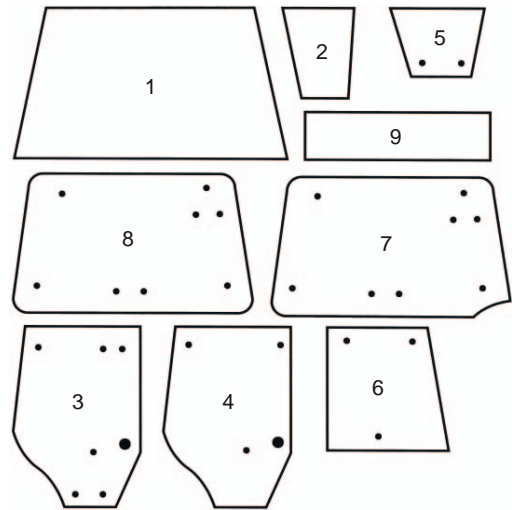

TUOTE-NRO	LASI	KUVAUS	ALKUPERÄIS- NUMERO	KOKO mm (k ork. x lev. x vahv.)	VÄRI	KIINNITYS	
1	T20015	Tuulilasi	kiinteä, ei avettava, kaareva	248715A1	1255 x 840 x 4	sävytetty	L
2	T20014	Alempi etu	oik., kaareva	1330877C1	610 x 415 x 4	sävytetty	L
2	T20013	Alempi etu	vas., kaareva	1330876C1	610 x 415 x 4	sävytetty	L
3	T20018 (a)	Oven	oik., 7 reikää, kaareva	1330930C2	1135 x 850 x 5	sävytetty	L
3	T20019 (a)	Oven	vas., 7 reikää, kaareva	1330931C1	1135 x 850 x 5	sävytetty	L
4	T20001 (b)	Ylempi oven	oik., 4 reikää, kaareva	1546817C2	1135 x 850 x 5	sävytetty	L
4	T20003 (b)	Ylempi oven	vas., 4 reikää, kaareva	1546818C2	1135 x 850 x 5	sävytetty	L
5	T20010	Alempi oven	oik., 2 reikää, kaareva	1999626C2	474 x 305 x 5	sävytetty	L
5	T20008	Alempi oven	vas., 2 reikää, kaareva	1999625C2	474 x 305 x 5	sävytetty	L
6	T20022	Sivulasi	oik., 3 reikää, kaareva	1330903C1	675 x 590 x 5	sävytetty	R/PK
6	T20007	Sivulasi	vas., 3 reikää, kaareva	1330902C1	675 x 590 x 5	sävytetty	R/PK
7	T20005 (c)	Ylempi taka	katso kuva, 8 reikää	127442A1	1230 x 624 x 5	sävytetty	R/PK
8	T2359 (d)	Ylempi taka	8 reikää	1330904C2	1230 x 624 x 5	sävytetty	R/PK
9	T20006	Alempi taka		1981934C1	865 x 365 x 5	kirkas	L

a - sopii sarjanumeroon JJF1020700 saakka
b - sopii sarjanumerosta JJF1020701 eteenpäin

c - sopii sarjanumerosta JJF1030001 eteenpäin
d - sopii sarjanumeroon JJF1030000 saakka



Maxxum Pro -sarja
5120, 5130, 5140, 5150

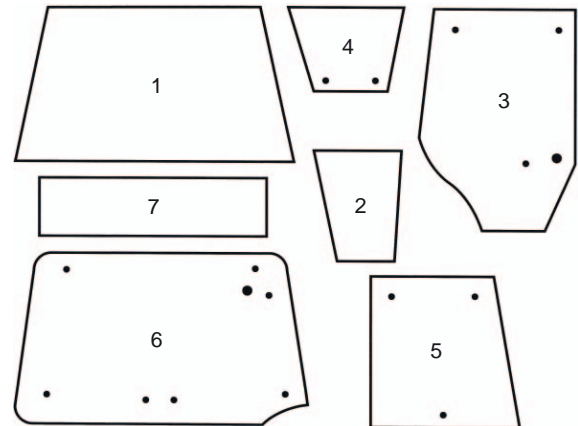

TUOTE-NRO	LASI	KUVAUS	ALKUPERÄIS- NUMERO	KOKO mm (k ork. x lev. x vahv.)	VÄRI	KIINNITYS	
1	T20015	Tuulilasi	kiinteä, ei avettava, kaareva	248715A1	1255 x 840 x 4	sävytetty	L
2	T20014	Alempi etu	oik., kaareva	248717A1	610 x 415 x 4	sävytetty	L
2	T20013	Alempi etu	vas., kaareva	248716A1	610 x 415 x 4	sävytetty	L
3	T20001	Ylempi oven	oik., 4 reikää, kaareva	248723A1	1135 x 850 x 5	sävytetty	L
3	T20003	Ylempi oven	vas., 4 reikää, kaareva	248724A1	1135 x 850 x 5	sävytetty	L
4	T20010	Alempi oven	oik., 2 reikää, kaareva	248726A1	474 x 305 x 5	sävytetty	L
4	T20008	Alempi oven	vas., 2 reikää, kaareva	248725A1	474 x 305 x 5	sävytetty	L
5	T20022	Sivulasi	oik., 3 reikää, kaareva	248719A1	675 x 590 x 5	sävytetty	R/PK
5	T20007	Sivulasi	vas., 3 reikää, kaareva	248718A1	675 x 590 x 5	sävytetty	R/PK
6	T20005	Ylempi taka	katso kuva, 8 reikää	248720A1	1230 x 624 x 5	sävytetty	R/PK
7	T20006	Alempi taka		1981934C1	865 x 365 x 5	kirkas	L

Kiinnitystavat: L = liimattu PK = pulttikiinnitys K = kehyksellä T = tiivisteellä R = reunasuojalla

E1.43

Alkuperäisnumerot ovat ainoastaan vertailua varten, eivätkä tarkoita, että tuotteet ovat alkuperäisiä. Taulukoissa esiintyvät kuvat ovat viitteellisiä.

25.07.2008

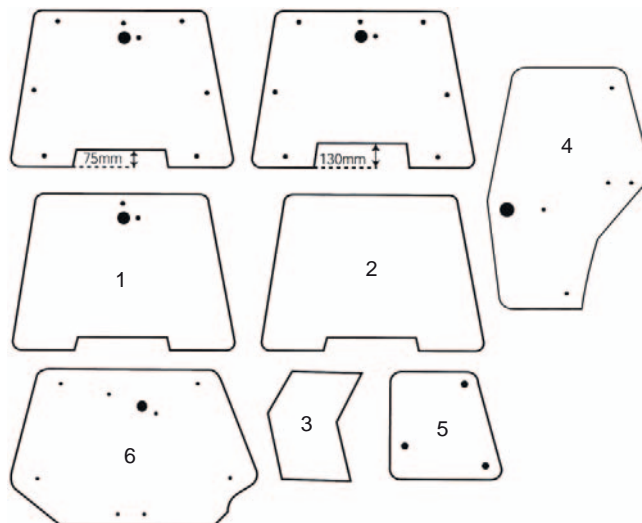

Case/IH CX, MX, MXC & McCormick CX, MTX

	TUOTE-NRO	LASI	KUVAUS	ALKUPERÄIS- NUMERO	KOKO mm (k ork. x lev. x vahv.)	VÄRI	KIINNITYS
1	T20035	Tuulilasi	kiinteä, ei avattava, 3 reikää, kaareva	238682A3	1335 x 795 x 5	sävytetty	L
2	T20036	Tuulilasi	kiinteä, ei avattava, kaareva	190034A4	1335 x 795 x 5	sävytetty	L
3	T20037	Alempi etu	vas., kaareva	190030A4	650 x 454 x 5	sävytetty	L
3	T20038	Alempi etu	oik., kaareva	190029A4	650 x 454 x 5	sävytetty	L
4	T20039	Oven	vas., 6 reikää, kaareva	192003A4	1415 x 895 x 6	sävytetty	R/PK
4	T20040	Oven	oik., 6 reikää, kaareva	192004A4	1415 x 895 x 6	sävytetty	R/PK
5	T20041	Sivulasi	vas., 3 reikää, kaareva	192001A2	687 x 483 x 5	sävytetty	R/PK
5	T20042	Sivulasi	oik., 3 reikää, kaareva	192002A2	687 x 483 x 5	sävytetty	R/PK
6	T20002	Takalasi	9 reikää, kaareva	284947A1	1290 x 855 x 6	sävytetty	R/PK

CS-sarja

100, 110, 120, 130, 150

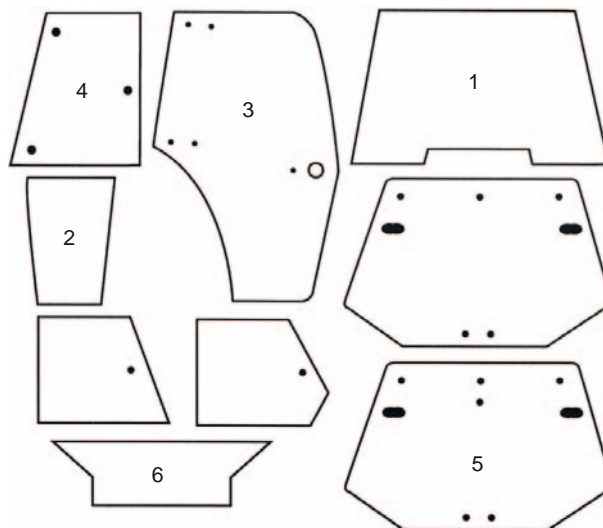

	TUOTE-NRO	LASI	KUVAUS	ALKUPERÄIS- NUMERO	KOKO mm (k ork. x lev. x vahv.)	VÄRI	KIINNITYS
1	T20043	Tuulilasi	kiinteä, ei avattava, kaareva	134671067	1233 x 915 x 5	sävytetty	L
2	T20044	Alempi etu	oik., kaareva	134671069	558 x 345 x 5	sävytetty	L
2	T20045	Alempi etu	vas., kaareva	134671070	558 x 345 x 5	sävytetty	L
3	T20046 (a)	Oven	oik., 6 reikää, kaareva	134621081	1450 x 865 x 6	sävytetty	L
4	T20048 (b)	Sivulasi	oik., 3 reikää	134671075	677 x 482 x 6	sävytetty	PK
4	T20049	Sivulasi	vas., 3 reikää	134671064	677 x 482 x 6	sävytetty	PK
5	T20020 (c)	Ylempi taka	8 reikää	1346710724	1205 x 655 x 5	sävytetty	PK
6	T20021	Alempi taka	yksiosainen	134671015	1170 x 307 x 5	sävytetty	L

a - korvaa numeron 134621046
b - korvaa numeron 134671065
c - korvaa numeron 134671062

Kiinnitystavat: L = liimattu
PK = pulttikiinnitys
K = kehyksellä
T = tiivisteellä
R = reunasuojalla

E1.44

Alkuperäisnumerot ovat ainoastaan vertailua varten, eivät käsitä tarkoituksella, että tuotteet ovat alkuperäisiä. Taulukoissa esiintyvät kuvat ovat viitteellisiä.

25.07.2008

OVEN ULKOKAHVA

T0139

3113466R91

- 238, 248, 258, 268, 384, 385, 484, 485, 584, 585, 674, 684, 685, 784, 785, 884, 885 (turvaohjaamolla)
- reikäväli 45 mm

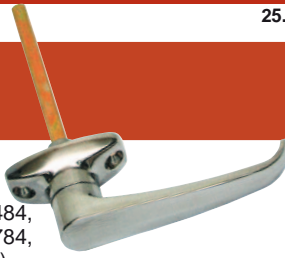

OVEN ULKOKAHVA LUKOLLA

VLD1413

3110945R91

- 454, 574, 2400 (sarja A), 2500 (sarja A) (turvaohjaamolla) 3434
- reikäväli 44,5 mm



OVEN ULKOKAHVA LUKOLLA

VLD1443

3125444R91

- 248, 258, 268, 484, 485, 584, 585, 684, 685, 784, 785, 884, 885 (super deluxe -ohjaamot)



OVEN ULKOKAHVA LUKOLLA

VLD1417

1328563C1

- 85 -sarjan traktorit "L" -ohjaamolla



OVEN ULKOKAHVA LUKOLLA

T2689

1971204C1

- 440, 540, 640, 3210, 3220, 3230, 4210, 4220, 4230, 4240 (→JJE0926239)
(LP-ohjaamo) 5120, 5130, 5140 (→JJF1020699)



OVEN ULKOKAHVA LUKOLLA

T2692

255195A1

- 3210, 3220, 3230, 4210, 4220, 4230, 4240 (JJE0926240→) (LP-ohjaamo)



OVEN LUKKO

Vasen
VLD1404
3112460R91

Oikea
VLD1405
3112461R91

- 238, 248, 2258, 268, 384, 385, 484, 485, 584, 585, 684, 685, 784, 785, 884, 885, 454, 574, 674, 2400 (sarja A)



OVEN SISÄLUKKO

Vasen
VLD1400
1328552C1

- 85-sarjan traktorit "L"-ohjaamolla



OVEN LUKKO + SISÄKAHVA

Vasen
VLD1436
K303805

Oikea
VLD1438
K303806

- Poclain-mallit
5120E,
5130E, 5140E



OVEN LUKKO

Vasen
T2690
1535126C1

Oikea
T2691
1535127C1

- 595XL, 695XL, 743XL, 745XL, 795XL, 844XL, 845XL, 856XL (XLN -ohjaamo), 3210, 3220, 3230, 4210, 4220, 4230, 4240, (LP-ohjaamo)



TAKALASIN KAHVA

T2693

224736A1

- 4210, 4220, 4230, 4240 (JKJ156937→)(XL -ohjaamo)



TAKALASIN KAHVA

T2694

224730A1

- 5120, 5130, 5140, 5150



E1.45

26.09.2011

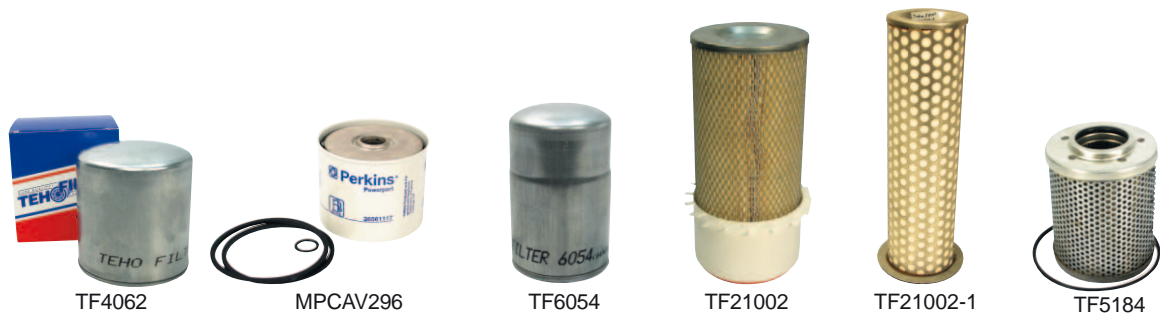

TRAKTORI-MALLI	ÖLJYN-SUODATIN	POLTTOAINESUODATIN CAV	ILMANSUODATIN BOSCH	ILMANSUODATIN ULOMPI	ILMANSUODATIN SISEMPI	HYDRAULI-SUODATIN
238, 248, 258, 268	TF4142 DFP550719 3136046R93		TF6206 DFP550588 (j) 3132428R2	TF21002 DFP771563 3125199R2	TF21002-1 DFP770181 3115569R2	DFP550128 93413C1
250, 275	TF5005 DFP550052 3110452R91	TF7004 704640R91				
250, 275, 276, 414, 434, 444	TF5005 DFP550052 3110452R91	MPCAV296 DFP556245 K960911		TF2210 (i)		
288	TF4074 DFP559418 1329020C2		TF6206 DFP550588 (j) 3132428R2	TF21002 DFP771563 3125199R2 TF2566 (a) 3125342R2	TF21002-1 DFP770181 3115569R2 TF2566-2 (a) 3125255R1	DFP550128 93413C1
354, 374, 384	TF5005 DFP550052 3110452R91	MPCAV296 DFP556245 3044506R93				
385, 395	TF4142 DFP550719 3136046R93	MPCAV296 DFP556245 3044506R93	TF6206 DFP550588 (j) 3132428R1	TF21002 DFP771563 3125199R2	TF21002-1 DFP770181 3115569R2	DFP550128 93413C1
453	TF4062 DFP551300 3136458R91	MPCAV296 DFP556245 K960911		TF2182-1 DFP140131		
454, 474, 574, 674	TF4142 DFP550719 3136046R93	MPCAV296 DFP556245 K960911	TF6206 DFP550588 (j) 3132428R2	TF2187 DFP771559 529854R2		TF5153 (c) DFP550128 (c) 530144R92
475	TF4500 DFP554403 3118119R1	MPCAV296 DFP556245 1502155C91		TF2187 DFP771559 529854R2		TF5153 (c) DFP550128 (c) 530144R92
484, 584, 684, 784, HYDRO 84	TF4142 DFP550719 3136046R93	MPCAV296 DFP556245 3044506R93	TF6206 DFP550588 (j) 3132428R2	TF2187 DFP771559 529854R2 TF21002 DFP771563 3125199R2	TF21002-1 DFP770181 3115569R2	TF5153 (c) DFP550128 (c) 530144R92
485, 485XL, 495, 495XL	TF4142 DFP550719 3136046R93	MPCAV296 DFP556245 3044506R93	TF6206 DFP550588 (j) 3132428R2	TF21002 DFP771563 3125199R2	TF21002-1 DFP770181 3115569R2	DFP550128 93413C1
523	TF4062 DFP551300 3136458R91		TF6206 DFP550588 (j) 3132428R2	TF2182-1 DFP140131 3146927R1	T2255 3148080R1	TF5184 (e) 3147441R92
533	TF4062 DFP551300 3136458R91	MPCAV296 DFP556245 K960911	TF6206 DFP550588 (j) 3132428R2	TF2182-1 DFP140131 3146927R1	T2255 3148080R1	TF5184 (e) 3224623R1
540	TF4062 DFP551300 3136458R91		TF6206 DFP550588 (j) 3132428R2	TF2182-1 DFP140131 3146927R1 TF21002 DFP771563 3125199R2	T2255 3148080R1 TF21002-1 DFP770181 3115569R2	TF5184 (e) 3224623R1
553	TF4062 DFP551300 3136458R91	MPCAV296 DFP556245 K960911				TF5184 (e) 3147441R92
585, 585XL, 595, 595XL	TF4142 DFP550719 3136046R93	MPCAV296 DFP556245 3044506R93	TF6206 DFP550588 (j) 3132428R2	TF21002 DFP771563 3125199R2 TF2566 (a) 3125342R2	TF21002-1 DFP770181 3115569R2 TF2566-2 (a) 3125255R1	DFP550128 93413C1
624, 724, 824	TF4062 DFP551300 3136458R91		TF6206 DFP550588 (j) 3132428R2	TF2182-1 DFP140131 3146927R1 TF2104-1 DFP181089 3146576R1	T2255 3148080R1 DFP777524 3147878R1	TF5184 (e) 3147441R92

Katso huomautukset sivulta E1.49

E1.46

Alkuperäisnumerot ovat ainoastaan vertailua varten, eivätkä tarkoita, että tuotteet ovat alkuperäisiä. Taulukoissa esiintyvät kuvat ovat viitteellisiä.

26.09.2011

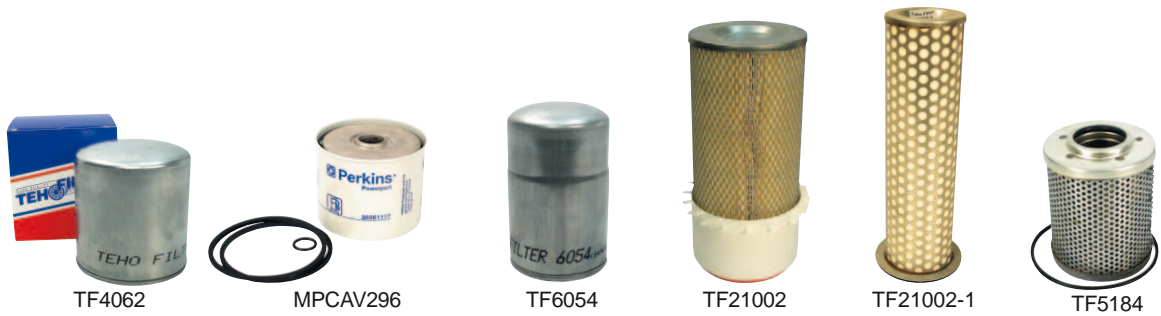

TRAKTORI-MALLI	ÖLJYN-SUODATIN	POLTTOAINESUODATIN CAV	BOSCH	ILMANSUODATIN ULOMPI	SISEMPI	HYDRAULI-SUODATIN
633, 640	TF4062 DFP551300 3136458R91	MPCAV296 DFP556245 K960911	TF6206 (j) DFP550588 (j) 3132428R2	TF2182-1 DFP140131 3146927R1	T2255 3148080R1	TF5184 (e) 3224623R1
644	TF4062 DFP551300 3136459R91	MPCAV296 DFP556245 3044506R93	TF6206 (j) DFP550588 (j) 3132428R2	TF2104-1 DFP181089 3146576R1	DFP777524 3147878R1	TF5184 (e) 3224623R1
654	TF4062 DFP551300 3136459R91	MPCAV296 DFP556245 K960911				
685, 685XL, 695, 695XL	TF4142 DFP550719 3136046R93	MPCAV296 DFP556245 3044506R93	TF6206 (j) DFP550588 (j) 3132428R2	TF21002 DFP771563 3125199R2 TF2566 (a) 3125342R2	TF21002-1 DFP770181 3115569R2 TF2566-2 (a) 3125255R1	DFP550128 93413C1
733	TF4062 DFP551300 3136459R91	MPCAV296 DFP556245 K960911	TF6206 (j) DFP550588 (j) 3132428R2	TF2182-1 DFP140131 3146927R1	T2255 3148080R1	TF5184 (e) 3224623R1
740, 840, 940	TF4062 DFP551300 3136459R91		TF6206 (j) DFP550588 (j) 3132428R2	TF2182-1 DFP140131 3146927R1 TF21002 DFP771563 3125199R2	T2255 3148080R1 TF21002-1 DFP770181 3115569R2	TF5184 (e) 3224623R1 T2164A (e) 1328276C1
743, 743XL	TF4062 DFP551300 3136459R91		TF6206 (j) DFP550588 (j) 3132428R2	TF2104-1 DFP181089 3146576R1 TF2566 (d) 3125342R2	DFP777524 3147878R1 TF2566-2 (d) 3125255R1	T2164A (e) 1328276C1 TF5184 (e) 3224623R1
744	TF4062 DFP551300 3136459R91	MPCAV296 DFP556245 3044506R93	TF6206 (j) DFP550588 (j) 3132428R2	TF2104-1 DFP181089 3146576R1	DFP777524 3147878R1	TF5184 (e) 3224623R1 (011022→)
745	TF4062 DFP551300 3136459R91		TF6206 (j) DFP550588 (j) 3124428R2	TF2104-1 DFP181089 3146576R1 TF2566 (a) 3125342R2	DFP777524 3147878R1 TF2566-2 (a) 3125255R1	T2164A (e) 1328276C1 TF5184 (e) 3224623R1
785, 785XL, 795, 795XL	TF4142 DFP550719 3136046R93	MPCAV296 DFP556245 3044506R93	TF6206 (j) DFP550588 (j) 3124428R2	TF21002 DFP771563 3125199R2 TF2566 (a) 3125342R2	TF21002-1 DFP770181 3115569R2 TF2566-2 (a) 3125255R1	DFP550128 93413C1
833	TF4062 DFP551300 3136459R91	MPCAV296 DFP556245 K960911	TF6206 (j) DFP550588 (j) 3124428R2	TF2104-1 DFP181089 3146576R1		TF5184 (e) 3224623R1
844	TF4062 DFP551300 3136459R91	MPCAV296 DFP556245 3044506R93	TF6206 (j) DFP550588 (j) 3124428R2	TF2104-1 DFP181089 3146576R1	DFP777524 3147878R1	TF5184 (e) 3224623R1 (005600→)
844S, 844XL	TF4062 DFP551300 3136459R91		TF6206 (j) DFP550588 (j) 3124428R2	TF2104-1 DFP181089 3146576R1 TF2566 (d) 3125342R2	DFP777524 3147878R1 TF2566-2 (d) 3125255R1	DFP550128 1328276C1
845, 845XL	TF4062 DFP551300 3136459R91		TF6206 (j) DFP550588 (j) 3132428R2	TF2104-1 DFP181089 3146576R1 TF2566 (a) 3125343R2	DFP777524 3147878R1 TF2566-2 (a) 3125255R1	T2164A (e) 1328276C1 TF5184 (e) 3224623R1

Katso huomautukset sivulta E1.49

E1.47

Alkuperäisnumerot ovat ainoastaan vertailua varten, eivätkä tarkoita, että tuotteet ovat alkuperäisiä. Taulukoissa esiintyvät kuvat ovat viitteellisiä.

26.09.2011

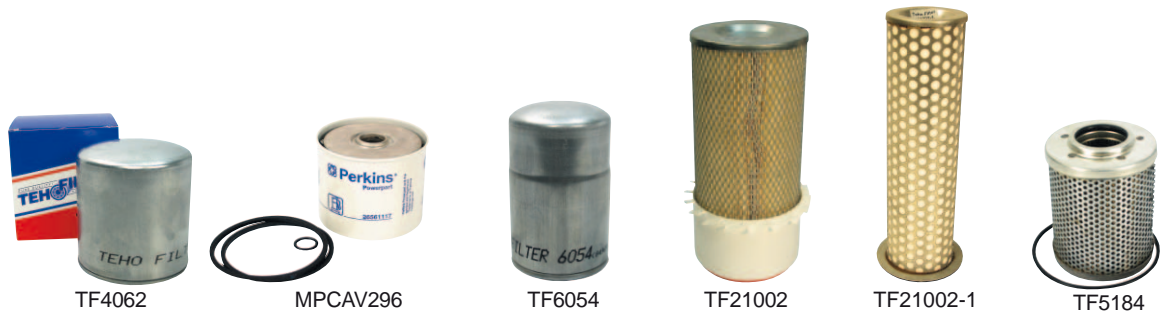

TRAKTORI-MALLI	ÖLJYN-SUODATIN	POLTTOAINESUODATIN CAV	BOSCH	ILMANSUODATIN ULOMPI	SISEMPI	HYDRAULI-SUODATIN
856XL	TF4074 DFP559418 1329020C2		TF6206 (j) DFP550588 (j) 3132428R2	TF2198 DFP181088 3146939R1	TF2198-2 DFP776694 3216100R1	T2164A (e) 1328276C1
884	TF4074 DFP559418 1329020C2	MPCAV296 DFP556245 3044506R93	TF6206 (j) DFP550588 (j) 3218794R91	TF2566 3125342R2	TF2566-2 3125255R1	TF5153 (c) DFP550128(c) 530144R92
885, 885XL, 895, 895XL	TF4074 DFP559418 1329020C2	MPCAV296 DFP556245 3044506R93	TF6206 (j) DFP550588 (j) 3132428R2	TF21002 DFP771563 3125199R2 TF2566 (a) 3125342R2	TF21002-1 DFP770181 3115569R2 TF2566-2 (a) 3125255R1	DFP550128 93413C1
946	TF4074 DFP559418 1329020C2	MPCAV296 DFP556245 K960911	TF6206 (j) DFP550588 (j) 3132428R2	TF2104-1 DFP181089 3146576R1	DFP777524 3147878R1	
955, 955XL	TF4074 DFP559418 1329020C2	MPCAV296 DFP556245 3044506R93	TF6206 (j) DFP550588 (j) 3218794R91	TF2104-1 DFP181089 3146576R1 TF2197 (b) DFP771561 3226416R1	DFP777524 3147878R1 TF2197-2 (b) 3219421R1	TF5184 (e) 3224623R1
956, 956XL, 1056, 1056XL	TF4074 DFP559418 1329020C2		TF6206 (j) DFP550588 (j) 3132428R2	TF2104-1 DFP181089 3146576R1 TF2197 (b) DFP771561 3226416R1	DFP777524 3147878R1 TF2197-2 (b) 3219421R1	T2164A (e) 1328276C1
985XL, 995XL	TF4074 DFP559418 1329020C2		TF6206 (j) DFP550588 (j) 3132428R2	TF2566 3125342R2	TF2566-2 3125255R1	DFP550128 93413C1
1046	TF4074 DFP559418 1329020C2	MPCAV296 DFP556245 3044506R93	TF6206 (j) DFP550588 (j) 3132428R2	TF2104-1 DFP181089 3146576R1	DFP777524 3147878R1	
1055, 1055XL	TF4074 DFP559418 1329020C2	MPCAV296 DFP556245 3044506R93	TF6206 (j) DFP550588 (j) 3132428R2	TF2104-1 DFP181089 3146576R1 TF2197 (b) DFP771561 3226416R1	DFP777524 3147878R1 TF2197-2 (b) 3219421R1	TF5184 (e) 3224623R1
1246	TF4074 DFP559418 1329020C2	MPCAV296 DFP556245 3044506R93		TF2198 DFP181088 3146969R1	TF2198-2 DFP776694 3216100R1	
1255, 1255XL, 1455, 1455XL	TF4074 DFP559418 1329020C2		TF6206 (j) DFP550588 (j) 3132428R2	TF2197 DFP771561 3226416R1	TF2197-2 3219421R1	T2164A (e) 1328276C1 3229787R1
2275	TF5005 DFP550052 3043283R91	MPCAV296 DFP556245 3044506R93				
2500D, 2504D	TF5111	TF7122 (x2)				
3210, 3220	TF4142 DFP550719 3136046R93		TF6206 (j) DFP550588 (j) 3132428R2	TF21002 DFP771563 3125199R2	TF21002-1 DFP770181 3115569R2	DFP550128 93413C1
3230, 4210, 4220	TF4142 DFP550719 3136046R93		TF6206 (j) DFP550588 (j) 3132428R2	TF21002 DFP771563 3125199R2 TF2566 (a) 3125342R2	TF21002-1 DFP770181 3115569R2 TF2566-2 (a) 3125255R1	DFP550128 93413C1

Katso huomautukset sivulta E1.49

E1.48

Alkuperäisnumerot ovat ainoastaan vertailua varten, eivätkä tarkoita, että tuotteet ovat alkuperäisiä. Taulukoissa esiintyvät kuvat ovat viitteellisiä.

TRAKTORI-MALLI	ÖLJYN-SUODATIN	POLTTOAINESUODATIN CAV	BOSCH	ILMANSUODATIN ULOMPI	SISEMPI	HYDRAULI-SUODATIN
4230	TF4074 DFP559418 1329020C2		TF6206 DFP550588 (j) 3132428R2	TF21002 DFP771563 3125199R2 TF2566 (a) 3125342R2	TF21002-1 DFP770181 3115569R2 TF2566-2 (a) 3125255R1	DFP550128 93413C1
4240	TF4074 DFP559418 1329020C2		TF6206 DFP550588 (j) 3132428R2	TF2566 3125342R2	TF2566-2 3125255R1	DFP550128 93413C1
5110, 5220	TF4349					
5120	TF4349		DFP551329 J925274 TF6206 DFP550588 (j) J903640	TF21007 DFP181059 D56453	TF21007-1 DFP119410 N8153	DFP165875 1976934C3
5130	TF4350 J908615		DFP550248 J843760	TF21007 DFP181059 D56453	TF21007-1 DFP119410 N8153	DFP165875 1976934C3
5140	TF4350 J908615		DFP551329 J925274 TF6206 DFP550588 (j) J903640	TF21007 DFP181059 D56453	TF21007-1 DFP119410 N8153	DFP165875 1976934C3
5150	TF4350 J908615		DFP551329 J925274 TF6206 DFP550588 (j) J903640	DFP132935 A47032	DFP132939 A47033	DFP165875 1976934C3
7110, 7120, 7130, 7140	DFP551381 (f) A77537 DFP553548 (g) J919562		DFP551329 J925274 TF6206 DFP550588 (j) J903640			DFP170949 1971728C1 DFP164384 (h) 1346028C1
MX100, 110, 120, 135	TF4350 (k) J903264 J908615		DFP550248 J931062 J843760			DFP165875 1976934C5 1973964C3
MX150, 170			DFP550248 J931062 J843760			
1046, 1055, 1055XL, 1246, 323, 354, 374, 383, 384, 385, 423, 433, 444, 453, 454, 474, 475, 484, 485, 485XL, 533, 553, 574, 580F, 580G, 584, 585, 585XL, 633, 644, 654, 674, 684, 685, 685XL, 724, 733, 743XL, 744, 784, 785, 785XL, 824, 833, 84 Hydro, 844, 844XL, 884, 885, 885XL, 946, 955, 955XL, B414, BD275, BD276, BD414, BD434, CX50, CX60		F0560 (l) 81862754 81866599 2656818				
MXM120, MXM130, MXM140, MXM155, MXM175, MXM190		F87803444 (m) 87803443 87803445 F87803441 (n) 87803442 F87840590 (o) 87802921	DFP551433 87802927			
MXM135, MXM150, MXM165, MXM180		F87840590 (o) 87802921				
TM120, TM130, TM140, TM155, TM175, TM190		F87803441 (n) 87803442				
CS100, CS110 (DBD0075001→)			DFP551429 (p) 14200080715			
CS80, CS90, CS100 + PRO CS120, CS130, CS150 (DBD0075001→) CSX120, CSX130, CSX150 (07/99→)			DFP551430 (p)			
CS80, CS85Pro, CS90, CS95Pro, CS100, CS105Pro, CVX1135, CVX1145, CVX1155, JX1070U, JX1080U, JX1090U, JX1100U, MTX125, MXM120, MXM130, MXM140, MXM155, MXM175, MXM190			DFP551425			

a - ilmastointilaitteella
 b - esipuhdistimella
 c - HD malli (DFP550128)
 d - Coopers tyyppi
 e - TF5184 korkeus 71 mm, T2164A korkeus 120 mm
 f - →44500127
 g - 44500128→
 h - lisähydrauliikka (ABJ0044915→)
 i - vain 444

j - vedenpoistoruuvilla
 k - →JJE095001
 l - kaksoismalli
 m - 30 micron, malleihin, joissa suodatinrungossa PA-pumppu
 n - 5 micron, FA097480→
 o - vedenerotinsuodatin, →FA097480
 p - ensiösuodatin

JÄÄHDYTYS- JÄRJESTELMÄN SUODATIN

DFP554071

A77544

- Case IH kaikki mallit, joissa nestesuodatin



OHJAAMON ILMANSUODATIN

TF21203

- Comfort-ohjaamot
- 418 x 167 x 49 mm



OHJAAMON ILMANSUODATIN

TF21240

- kaikki XL-ohjaamot



OHJAAMON ILMANSUODATIN

TF21124

143381C2

- Maxxum, Magnum, 5120, 5130, 5140, 5150, 7110, 7120, 7130, 7140
- 962 x 152 x 64 mm

SYKLONI ESIPUHDISTIN

Esipuhdistin säästää koneen varsinaista ilmanpuhdistinta. Syklonissa ilma joutuu pyörivään liikkeeseen ja epäpuhtaudet jäävät syklonin pohjalle. Puhdistettava ajoittain.

DFH001249

1693129M1

- putkikoko 3"/76 mm
- varalasi **DFP020227**



DFH000820

- putkikoko 3"/76 mm
- varalasi **DFP016330**

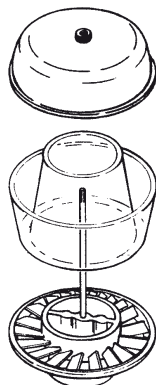

DFH000822

- putkikoko 4"/101 mm
- varalasi **DFP016330**

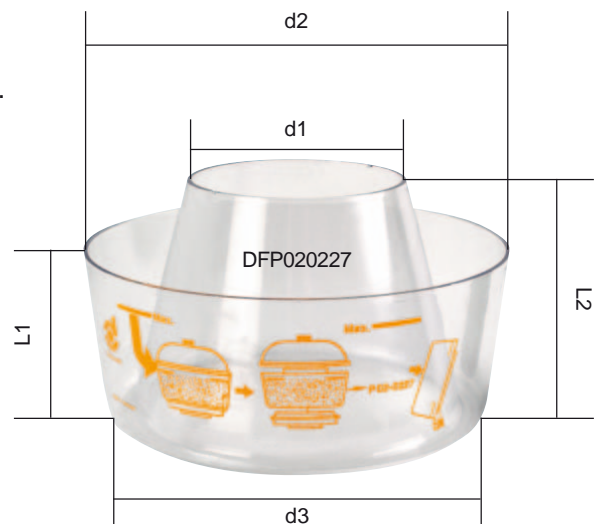

VARALASIN MITAT

MITAT	DFP020227	DFP016330
d1 mm	90	141
d2 mm	183,5	266
d3 mm	140	217,5
L1 mm	77	75,5
L2 mm	106	101,5