



TRAKTORI-MALLI	SYLINTERI-LUKU	TURBO	SYLINTERIN HALKAISUUS	MOOTTORI-TYYPPI	VUOSI-MALLI
33, 359				309D	
361, 361-2	3		100	310D	
565	3		100	310A	
565-2	3		100	310B	
500, 542	3		100	310B	
502	3		100	310B	1971-
502E, 504	3		100	310B	-1974
502S	3		100	310B	-1976
502	3		100	310B	-1982
602, 612	3		108	311C	1978-1982
602T		T	108	311CS	1980-1982
864	4		108	411D	
700	4		108	411A, 411AS	1968-1969
700MK2	4		108	411A7	1969-1973
900	4		108	411B	1967-1973
1100	3	T	108	411AS	1969-1974
504	3		108	311C	1982-1985
604 →7832			108	311C	1982-1985
604 7833→	3		108	311C	
604T →21391		T	108	311CS	1982-1985
604T 21392→	4		108	311CS	
702, 712	4		108	411B	1972-1979
702	4		108	411C	1979-1980
702S	4	T	108	411BS	1974-1979
702, 703	4		108	411C	1979-1980
802, 803	4	T	108	411CS	1980-1983
903	4	T	108	411CS	1979-1983
1102	4	T	108	411BS	1973-1979
1102, 1103	4	T	108	411CS	1979-1980
1203 →39581	4	T	108	411CX	1980-1983
1203 39582→			108		
1502	6	T	108	611CS	1975-1980
205	3		100	309D	1989-1991
305, 405, 415, 415M	3	T	100	309DS	1985-1989
355 →656312	3		108	311D	1980-1990
355 656316→	3		108	320D	1990-1994
455, 555 656315	3	T	108	311DS	1989-1994
455, 555 656316→	3	T	108	320DS	1990-1992
505, 605, 615	3	T	108	311DS	1983-1989
655	4		108	411D	1988-1989
655T	4	T	108	411DS	1990-1991
705, 755	4	T	108	411DS	1983-1991
805, 855, 815	4	T	108	411DS	1983-1991
905, 915	6		108	611D	1984-1991
255	3		108	320D	1992-1994
305, 405, 415, 415M	3	T	100	309DS	1991-1996
355	3		108	320D	1990-1994
365 656316→	3		108	320D	1994-1997
455, 555 →656315	3	T	108	311DS	1991-1996
455, 555 656316→	3	T	108	320DS	1991-1996
465, 565 656316→	3	T	108	320DS	1993-1997
665	4		108	420D	1992-1997



TRAKTORI-MALLI	SYLINTERI-LUKU	TURBO	SYLINTERIN HALKAISIJA	MOOTTORI-TYYPPI	VUOSI-MALLI
865, 865S	4	T	108	420DS	1996-1997
2005	6	T	120	VOLVO TD60B	1986-1987
2105	6	TI	120	VOLVO TD60B	1986-1987
6000	4		108	420D	1993-1996
6100	3	T	108	320DS	1991-1994
6200	4	T	108	420DSRE	1996-2000
6300	4	T	108	420DS	1991-2001
6300	4	T	108	420DSRE	2001-2003
6300	4	T	108	44DT	2003-
6400	4	T	108	420DS	1991-1994
6400	4	T	108	420DW	1994-2000
6400	4	T	108	420DWRE	2000-2003
6400	4	T	108	44ET	2003-
6600	4	T	108	420DS	1991-2000
6800	4	TI	108	420DWI	1996-2001
6800	4	TI	108	420DWRIE	2001-2003
6900	6	T	108	620DRE	1997-2000
6550	4	T	108	420DWRE	1998-2003
6750	4	TI	108	420DWRIE	2002-2003
6850	4	TI	108	420DWRIE	1998-2003
8050	6	T	108	620DS/DSR	1995-2001
8050	6	T	108	620DSRE	2001-2003
8050	6	T	108	66EWA	2003-2004
8000	6		108	620D	1991-1996
8100	6		108	620D	1990-1996
8100TS	6	T	108	620DS	1992-1993
8300	6		108	612D	1990-1992
8600	6	T	108	612DS	1990-1994
8800	6	T	108	634DS	1994-1996
8400	6	T	108	620DS	1996-2005
8400	6	T	108	620DSIE	2002-2004
8150	6	T	108	620DS/DSR	1995-2001
8150	6	T	108	620DSRE	2001-2003
8150	6	T	108	66EWA	2003-2004
8450	6		108	620DW/DWR	1995-2001
8550	6	T	108	634DS/DSR	1995-2001
8750	6	T	108	634DS SIGMA	1995-2000
365	3		108	320D	1994-1997
465	3	T	108	320DS	1993-1997
665	4		108	420D	1992-1997
865, 865S	4	T	108	420DS	1996-1997
600	3		108	320D/DE	1997-2002
700	3	T	108	320DS/DSRE	1997-2002
800	4		108	420DR	1997-2001
800	4	T	108	420DSRE	2001-2002
900	4	T	108	420DSR	1997-2001
900	4	T	108	420DSRE	2001-2002
6250HI, 6350HI	4		108	420DSRE	2003-
6350HI	4	T	108	44DT	2003-
6550HI, 6650HI	4	T	108	420DWRE	1998-2003
6550HI	4	T	108	44ET	2003-
6750HI (Eco Power)	4	TI	108	420DWRIE	2002-2003
6850HI	4	TI	108	420DWRIE	1998-2003
6850HI	4	TI	108	44EWI	2004-
8050HI	6	T	108	620DSRE	1998-2003
8050HI	6	T	108	66EWA	2003-2004
8150HI	6	T	108	620DSRE	1998-2003
8350HI (Eco Power)	6	T	108	620DSRIE	1998-2003
8450HI	6	T	108	620DWRE	1995-2001
8550HI	6	T	108	634DSRE	1998-2003
8950HI	6	T	108	634DSBIE SIGMA	1998-2002

Eco Power = matalakierrosmalli

T = Turbo

TI = Turbo Intercooler

**G1.02**

Alkuperäisnumerot ovat ainoastaan vertailua varten, eivätkä tarkoita, että tuotteet ovat alkuperäisiä. Taulukoissa esiintyvät kuvat ovat viitteellisiä.

**Moottori on koottu laadukkaista Long Life-takuuosista ja maalattu alkuperäisellä värillä. Takuu 6 kk.**

## Tehdyt toimenpiteet:

### Sylinteriryhmä

- putkitettu
- tiivistepinta tasohiottu
- koeponnistettu
- runkolaakerilinja tarkistettu

### Kampiaksi

- särötarkastettu
- tarvittaessa hiottu tai kiillotettu

### Kiertokanki

- laakeripesät tarkistettu
- helat uusittu
- suoruuus tarkistettu

### Nokka-akseli ja jakohammaspyörästä Ford-moottoreissa

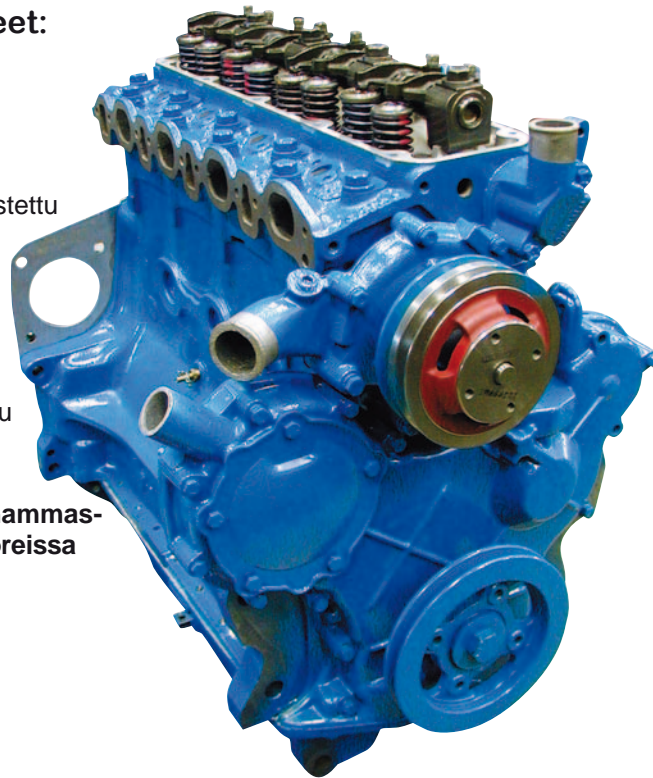

## Uusia osia vaihtopuolimoottorissa ovat:

- männät
- putket
- renkaat
- laakerit
- tiivistesarja täydellinen
- pakkastulpat
- öljykello
- vesihana

Tuotteet saatavana ilman vaihtoyksikköä tai vanhan yksikön voi palauttaa.

TUOTENO.	MOOTTORITYYPPI	SOVELTUVUUS
H0027	310B	Valmet 361, 565, 500, 502, ...
H0039	311C, 311CS	Valmet 602, 604, 612, ...
H0040	311D, 311DS	Valmet 505, 605, 615, ...
H0028	411B	Valmet 702, kuivaputkikone
H0029	411C	Valmet 702, 703, ...
H0038	411DS	Valmet 655T, 705, 755, 805, 855, ...

## VAIHTOPUOLIKANNET

### Tehdyt toimenpiteet:

- koeponnistettu
- tiivistepinnat tasohiottu
- venttiilin ohjurit koneistettu tai vaihdettu uusiin
- pakkastulpat uusittu
- maalattu alkuperäisiin väreihin

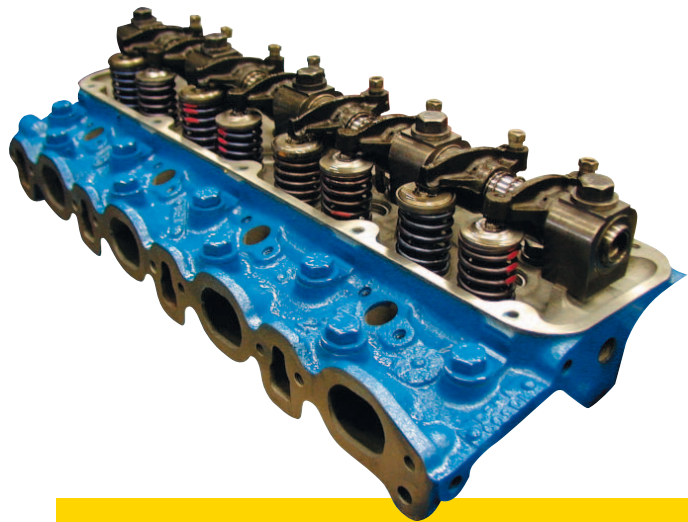

Tuotteet saatavana ilman vaihtoyksikköä tai vanhan yksikön voi palauttaa.

TUOTENO.	MOOTTORI- TYYPPI	SOVELTUVUUS
H048	311DS	Valmet 311DS
H049	411DS	Valmet 411DS
H053	310B	Valmet 365-502
H054	411B	Valmet 702B
H055	411C	Valmet 702C

## VAIHTOKAMPIAKSELIT

### Tehdyt toimenpiteet:

- hiottu tai kiillotettu
- särötarkastettu

### Vaihtokampiaksi sisältää:

- kiertokangen laakerit
- runkolaakerit
- päittäislaakerit

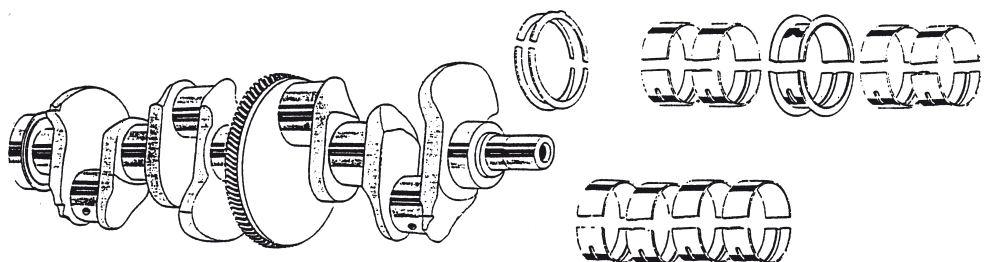

Tuotteet saatavana ilman vaihtoyksikköä tai vanhan yksikön voi palauttaa.

TUOTENO.	SOVELTUVUUS
H084	Valmet 359, 361, 500, 502, 504, 565
H085	Valmet 702 B
H086	Valmet 702 C

15.06.2007

## ASENNUSPAIKKA

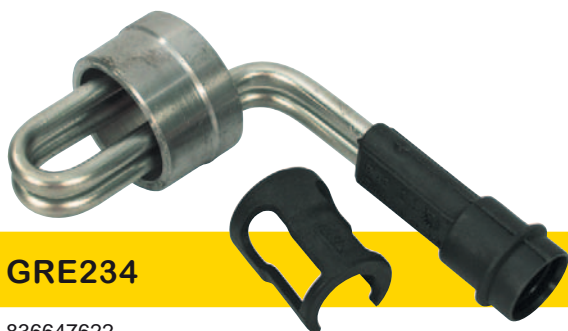
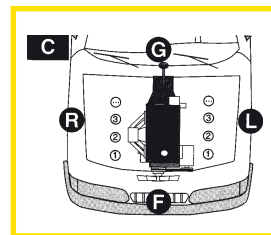

**GRE234**

836647622

- sopii: 365 moottorityyppi 320D  
255, 355, 365, 455, 465, 555, 565, 665, 865, 600, 700, 800,  
900, 6000, 6100, 6200, 6300, 6400, 6600, 6800,  
6250HI, 6350HI, 6550HI, 6650HI, 6750HI, 6850HI,  
A75N, A85N, A95N, C90, C100, C110, C120, C130, C150,  
M120, M130, M150
- asennuspaikka C-L
- johtosarja **GMKMS1525**

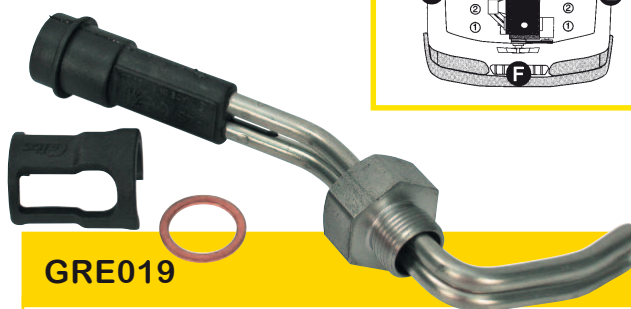

**GRE019**

836430362

- sopii:  
205, 305, 405, 502, 505, 602, 604, 605  
655, 905 moottorityyppi 309/311
- asennuspaikka C-L
- johtosarja **GMKMS1025**



**GRE065**

- sopii:  
33, 359, 361, 500, 565, 865
- asennuspaikka C-L2
- johtosarja **GMKMS1025**



**GRE095**

- sopii:  
702, 1102  
703, 903 moottorityyppi 411B
- asennuspaikka C-R
- johtosarja **GMKMS1525**



**GRE130**

836130363

- sopii:  
1502, 343, 702, 703, 802, 903  
905 moottorityyppi 411/611  
655, 705, 755, 805, 855, 715M, 905
- asennuspaikka C-L2
- johtosarja **GMKMS1025**



**GRE238**

836847596

- sopii:  
8000, 8100, 8200, 8400, 8050, 8150, 8450, 8550, 8750,  
8050HI, 8150HI, 8350HI, 8450HI, 8550HI, 8950HI,  
T120, T130, T140E, T150, T160, T170, T180, T190,  
T120C, T120CH, T130C, T130CH, T140EC, T140ECH,  
T160C, T160CH, T170C, S280
- asennuspaikka C-L
- johtosarja **GMKMS1525**

15.06.2007



## KAAPELISARJAT Calix vaihtovastuksiin



GMKMS1025

### GMKMS1025

- liitosjohto 2,5 m (mini)
- elementtikaapeli 1 m

### GMKMS1525

- liitosjohto 2,5 m (mini)
- elementtikaapeli 1,5 m

## LIITÄNTÄJOHDOT Calix pieni



### GMS25

- pituus 2,5 m

### GMS50

- pituus 5 m

Katso muut Calix-tuotteet Tarvikeluettelon T1-väliköstä

## T5086

- 33, 359, 361, 565, 500, 502, 504  
- \* sarja ei sisällä päittäislaakereita

T5056	Mäntä	3 kpl
T5066	Männänrengassarja	3 kpl
T5061	Sylinteriputki	3 kpl
T5078	Tiivistesarja	1 kpl
T5068	KK-laakeripari	3 kpl
T5070	RK-laakeripari*	4 kpl

## 702, 712, 903, 1102, 1112

- mäntä sisältää männänrenkaat

T5058	Mäntä	4 kpl
T5062	Sylinteriputki	4 kpl
T5081	Tiivistesarja	1 kpl
T5171	Päittäislaakeripari	2 kpl
T5069	KK-laakeripari STD	4 kpl
T5069A	KK-laakeripari 025	4 kpl
T5069B	KK-laakeripari 050	4 kpl
T5069D	KK-laakeripari 1 mm	4 kpl
T5072	RK-laakeripari STD	5 kpl
T5072A	RK-laakeripari 025	5 kpl
T5072B	RK-laakeripari 050	5 kpl
T5072D	RK-laakeripari 1 mm	5 kpl

## T5089

- 702, 703  
- märkä sylinteriputki

T5059	Mäntä	4 kpl
T5067	Männänrengassarja	4 kpl
T5063	Sylinteriputki	4 kpl
T5082	Tiivistesarja	1 kpl
T5069	KK-laakeripari STD	4 kpl
T5072	RK-laakeripari STD	5 kpl
T5171	Päittäislaakeripari	2 kpl

## T5090

- 802, 803, 812, 902, 903, 912, 1102, 1103, 1112  
- märkä sylinteriputki

T5260	Mäntä	4 kpl
T5067	Männänrengassarja	4 kpl
T5063	Sylinteriputki	4 kpl
T5082	Tiivistesarja	1 kpl
T5069	KK-laakeripari STD	4 kpl
T5072	RK-laakeripari STD	5 kpl
T5171	Päittäislaakeripari	2 kpl

## T5091

- 602, 612, 604, 604T, 615  
- märkä sylinteriputki

T5059	Mäntä	3 kpl
T5067	Männänrengassarja	3 kpl
T5063	Sylinteriputki	3 kpl
T5079	Tiivistesarja	1 kpl
T5069	KK-laakeripari STD	3 kpl
T5072	RK-laakeripari STD	4 kpl
T5171	Päittäislaakeripari	2 kpl

## T5216

- 505, 605, 615  
- märkä sylinteriputki

T5260	Mäntä	3 kpl
T5067	Männänrengassarja	3 kpl
T5063	Sylinteriputki	3 kpl
T5288	Tiivistesarja	1 kpl
T5069	KK-laakeripari STD	3 kpl
T5072	RK-laakeripari STD	4 kpl
T5171	Päittäislaakeripari	2 kpl

## T5217

- 705, 805, 755, 855, 715, 815  
- märkä sylinteriputki

T5260	Mäntä	4 kpl
T5067	Männänrengassarja	4 kpl
T5063	Sylinteriputki	4 kpl
T5263	Tiivistesarja	1 kpl
T5069	KK-laakeripari STD	4 kpl
T5072	RK-laakeripari STD	5 kpl
T5171	Päittäislaakeripari	2 kpl

## 905, 915

- märkä sylinteriputki

T5059	Mäntä	6 kpl
T5067	Männänrengassarja	6 kpl
T5063	Sylinteriputki	6 kpl
T5292	Tiivistesarja	1 kpl
T5069	KK-laakeripari STD	6 kpl
T5069A	KK-laakeripari 025	6 kpl
T5069B	KK-laakeripari 050	6 kpl
T5069D	KK-laakeripari 1 mm	6 kpl
T5072	RK-laakeripari STD	7 kpl
T5072A	RK-laakeripari 025	7 kpl
T5072B	RK-laakeripari 050	7 kpl
T5072D	RK-laakeripari 1 mm	7 kpl
T5171	Päittäislaakeripari	2 kpl

## T5576

- 600, 6200 (-K14993), 6300 (-L10005),  
6400, 6600, 6800, 6300 (L10006-),  
6350Hi, 6550Hi (-N11770)  
6650Hi, 6750Hi, 6850Hi

T5544	Mäntä	4 kpl
T5545	Männänrengassarja	4 kpl
T5264	Sylinteriputki	4 kpl
T5563	Tiivistesarja	1 kpl
T5069	KK-laakeripari STD	4 kpl
T5072	RK-laakeripari STD	5 kpl
T5171	Päittäislaakeripari	2 kpl

## 8000, 8100, 8050 (-L10240), 8150 (-L10725)

T5544	Mäntä	6 kpl
T5545	Männänrengassarja	6 kpl
T5264	Sylinteriputki	6 kpl
T5564	Tiivistesarja	1 kpl
T5069	KK-laakeripari STD	6 kpl
T5069A	KK-laakeripari 025	6 kpl
T5069B	KK-laakeripari 050	6 kpl
T5069D	KK-laakeripari 1 mm	6 kpl
T5072	RK-laakeripari STD	7 kpl
T5072A	RK-laakeripari 025	7 kpl
T5072B	RK-laakeripari 050	7 kpl
T5072D	RK-laakeripari 1 mm	7 kpl
T5171	Päittäislaakeripari	2 kpl

## 8200, 8550, 8750, 8550Hi, 8950Hi

T5569	Mäntä	6 kpl
T5264	Sylinteriputki	6 kpl
T5564	Tiivistesarja	1 kpl
T5069	KK-laakeripari STD	6 kpl
T5069A	KK-laakeripari 025	6 kpl
T5069B	KK-laakeripari 050	6 kpl
T5069D	KK-laakeripari 1 mm	6 kpl
T5072	RK-laakeripari STD	7 kpl
T5072A	RK-laakeripari 025	7 kpl
T5072B	RK-laakeripari 050	7 kpl
T5072D	RK-laakeripari 1 mm	7 kpl
T5171	Päittäislaakeripari	2 kpl

## 8400, 8450, 8350Hi, 8450Hi

T5544	Mäntä	6 kpl
T5545	Männänrengassarja	6 kpl
T5264	Sylinteriputki	6 kpl
T5564	Tiivistesarja	1 kpl
T5069	KK-laakeripari STD	6 kpl
T5069A	KK-laakeripari 025	6 kpl
T5069B	KK-laakeripari 050	6 kpl
T5069D	KK-laakeripari 1 mm	6 kpl
T5072	RK-laakeripari STD	7 kpl
T5072A	RK-laakeripari 025	7 kpl
T5072B	RK-laakeripari 050	7 kpl
T5072D	RK-laakeripari 1 mm	7 kpl
T5171	Päittäislaakeripari	2 kpl

## 8050 (L10241-), 8150 (L10726-), 8050Hi, 8150Hi, T120, T130 +C-mallit

T5570	Mäntä	6 kpl
T5264	Sylinteriputki	6 kpl
T5564	Tiivistesarja	1 kpl
T5069	KK-laakeripari STD	6 kpl
T5069A	KK-laakeripari 025	6 kpl
T5069B	KK-laakeripari 050	6 kpl
T5069D	KK-laakeripari 1 mm	6 kpl
T5072	RK-laakeripari STD	7 kpl
T5072A	RK-laakeripari 025	7 kpl
T5072B	RK-laakeripari 050	7 kpl
T5072D	RK-laakeripari 1 mm	7 kpl
T5171	Päittäislaakeripari	2 kpl

## 665, 865, 800 (uud.), 900 (uud.)

T5544	Mäntä	4 kpl
T5262	Männänrengassarja	4 kpl
T5264	Sylinteriputki	4 kpl
T5561	Tiivistesarja	1 kpl
T5069	KK-laakeripari STD	4 kpl
T5069A	KK-laakeripari 025	4 kpl
T5069B	KK-laakeripari 050	4 kpl
T5069D	KK-laakeripari 1 mm	4 kpl
T5072	RK-laakeripari STD	5 kpl
T5072A	RK-laakeripari 025	5 kpl
T5072B	RK-laakeripari 050	5 kpl
T5072D	RK-laakeripari 1 mm	5 kpl
T5171	Päittäislaakeripari	2 kpl

## 6100

T5544	Mäntä	3 kpl
T5545	Männänrengassarja	3 kpl
T5264	Sylinteriputki	3 kpl
T5562	Tiivistesarja	1 kpl
T5069	KK-laakeripari STD	3 kpl
T5069A	KK-laakeripari 025	3 kpl
T5069B	KK-laakeripari 050	3 kpl
T5069D	KK-laakeripari 1 mm	3 kpl
T5072	RK-laakeripari STD	4 kpl
T5072A	RK-laakeripari 025	4 kpl
T5072B	RK-laakeripari 050	4 kpl
T5072D	RK-laakeripari 1 mm	4 kpl
T5171	Päittäislaakeripari	2 kpl

## 205, 305, 405, 415

T5531	Mäntä	3 kpl
T5532	Männänrengassarja	3 kpl
T5533	Sylinteriputki	3 kpl
T5559	Tiivistesarja	1 kpl
T5068	KK-laakeripari STD	3 kpl
T5068A	KK-laakeripari 025	3 kpl
T5068B	KK-laakeripari 050	3 kpl
T5070	RK-laakeripari STD	4 kpl
T5070A	RK-laakeripari 025	4 kpl
T5070B	RK-laakeripari 050	4 kpl
T5169	Päittäislaakeripari	2 kpl



04.03.2011

## Valmet Valtra moottorinkorjaussarjat STD sisältää:

- männät
- männänrenkaat
- sylinteriputket
- täydellisen tiivistesarjan
- päittäislaakerit (ei sarjassa T5086)
- kk-laakerit STD
- rk-laakerit STD



T5086



T5544



T5067



T5063

TRAKTORI-MALLI	MOOTTORI-TYYPPI	1. MOOTTORIN-KORJAUSSARJA STD	2. MÄNTÄ	3. MÄNNÄN-RENGASSARJA	4. PUTKI
33, 359, 361, 565, 500, 502, 504	310	<b>T5086</b> (k) 836039027	<b>T5056</b> (e) 836015548	<b>T5066</b> (a) 836015816	<b>T5061</b> 836006525
700, 900, 700, 702	411A 411B			<b>T5067</b> (d) 836339201 <b>T5067A</b> (e) 836114058	<b>T5062</b> (h) 836110233
702S, 1100	411AS		<b>T5058</b> (l) 836115896	<b>T5067</b> (d) 836339201 <b>T5067A</b> (e) 836114058	<b>T5062</b> (h) 836110233
602, 612, 604, 604T, 615	311C, CS	<b>T5091</b> 836439784	<b>T5059</b> 835316177	<b>T5067</b> 836339201	<b>T5063</b> (i) 835322787
702, 712, 903, 1102, 1112	411B, BS	<b>T5088</b> 836139311	<b>T5058</b> (l) 836115896	<b>T5067</b> (d) 836339201 <b>T5067A</b> (e) 836114058	<b>T5062</b> (h) 836110233
702, 703	411C	<b>T5089</b> 836139423	<b>T5059</b> 835316177	<b>T5067</b> 836339201	<b>T5063</b> (i) 835322787
802, 803, 812, 902, 903, 912, 1102, 1103, 1112	411CS	<b>T5090</b> 836139424	<b>T5260</b> 836330700	<b>T5067</b> 836339201	<b>T5063</b> (i) 835322787
205, 305, 405, 415	309D, DS	<b>T5215</b> 836540084	<b>T5531</b> 836531922	<b>T5532</b> 836539010	<b>T5533</b> 836536827
355, 455, 555	311D, DS →656315		<b>T5059</b> 835316177	<b>T5067</b> 836339201	<b>T5063</b> (i) 835322787
255, 355, 455, 555, 365, 465, 565	320D, DS 656316→		<b>T5544</b> 836655269	<b>T5545</b> (m) 836640078 <b>T5262</b> (n) 836640126	<b>T5264</b> 836647420
600 700	320DE 320DSRE		<b>T5544</b> 836655269	<b>T5545</b> (m) 836640078 <b>T5262</b> (n) 836640126	<b>T5264</b> 836647420
505, 605, 615	311DS	<b>T5216</b> 836440085	<b>T5260</b> 836330700	<b>T5067</b> 836339201	<b>T5063</b> (i) 835322787
705, 805, 755, 855, 715, 815	411DS	<b>T5217</b> 836140036	<b>T5260</b> 836330700	<b>T5067</b> 836339201	<b>T5063</b> (i) 835322787
655	411D, DS		<b>T5059</b> 835316177	<b>T5067</b> 836339201	<b>T5063</b> (i) 835322787

- a - 4-renkainen  
d - 3-renkainen ylärengas 2,5 mm  
e - 4-renkainen ylärengas 3 mm

Huom. Jos mäntä 4-renkainen, mutta yläura 2,5 mm, käytä **T5067** ja jätä kolmas rengasura tyhjäksi

- i - **T5063** märkä putki  
h - **T5062** kuiva putki  
k - **T5086** ei sisällä päittäislaakereita  
l - sisältää männänrenkaat  
m - sopii mäntään **T5544**  
n - sopii Valtran oem mäntään **836655269**

**G1.05**

26.09.2011

## Valmet Valtra moottorinkorjaussarjat STD sisältää:

- männät
- männänrenkaat
- sylinteriputket
- täydellisen tiivistesarjan
- päittäislaakerit (ei sarjassa T5086)
- kk-laakerit STD
- rk-laakerit STD



T5544



T5262



T5264

TRAKTORI-MALLI	MOOTTORI-TYYPPI	1. MOOTTORIN-KORJAUSSARJA STD	2. MÄNTÄ	3. MÄNNÄN-RENGASSARJA	4. PUTKI
665, 865, 800, 900	420D, DS 420D, DSRE	<b>T5582</b> 836740334	<b>T5544</b> 836655269	<b>T5262</b> (n) 836640126 <b>T5545</b> (m)	<b>T5264</b> 836647420
905, 915	611D	<b>T5218</b> 836340268	<b>T5059</b> 835316177	<b>T5067</b> (d) 836339201	<b>T5063</b> (i) 835322787
6100	320DS	<b>T5583</b> 836640292	<b>T5544</b> 836640073	<b>T5545</b> 836640078	<b>T5264</b> 836647420
6000 6300, 6400 6250HI, 6350HI	420D 420DS 420DSRE	<b>T5575</b> 836740287	<b>T5544</b> 836655269	<b>T5262</b> (n) 836640126 <b>T5545</b> (m)	<b>T5264</b> 836647420
6400, 6600 6800 6550HI, 6650HI 6850HI	420DW 420DSI 420DWRE 420DWRIE	<b>T5576</b> 836740288	<b>T5544</b> 83664073	<b>T5545</b> 836640078	<b>T5264</b> 836647420
8000, 8100 8050, 8150	620D 620DS	<b>T5577</b> 836840241	<b>T5544</b> 836655269	<b>T5262</b> (n) 836640126 <b>T5545</b> (m)	<b>T5264</b> 836647420
8050HI, 8150HI	620DSRE	<b>T5580</b> 836862101	<b>T5570</b> 836659702	<b>T5262</b> 836640126	<b>T5264</b> 836647420
8400 8450 8350HI, 8450HI	620DS 620DWR 620DWRE	<b>T5579</b>	<b>T5544</b> 836640073	<b>T5545</b> 836640078	<b>T5264</b> 836647420
8200 8550, 8750 8550HI 8950HI	634D 634DS 634DSRE 634DSBE	<b>T5578</b> 836840795	<b>T5569</b> (l) 836840596	<b>T5545</b> 836640078	<b>T5264</b> 836647420
8300, 8600	612D, DS			<b>T5067</b> (d) 836339201	
A75n, A85n, A95n T120, T130			<b>T5570</b> 836659702		<b>T5264</b> 836647420
T140, T160, T170					<b>T5264</b> 836647420
Teollisuusmoottorit	611CS		<b>T5260</b> 835316033	<b>T5067</b> (d) 836339201	<b>T5063</b> 835322787

d - 3-renkainen ylärengas 2,5 mm

i - **T5063** märkä putki

l - sisältää männän renkaat

m - sopii mäntään **T5544**

n - sopii Valtran mäntään **836655269**

## MÄNNÄNRENGASSARJA

### T5262

836640126

Sopii mäntään  
836655269

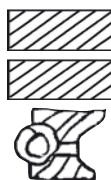

I 2,5 mm

II 2,5 mm

III 4,0 mm

## MÄNNÄNRENGASSARJA

### T5545

836640078



I kartio 2,8 mm

II 2,5 mm

III 4,0 mm

**G1.06**

26.09.2011

## Huom.

Alikokolaakereita

0,25 mm	0,50 mm	1,00 mm
T5068A	T5068B	T5068D
T5069A	T5069B	T5069D
T5070A	T5070B	
T5072A	T5072B	T5072D



T5069



T5072



T5171



T5094

TRAKTORI-MALLI	MOOTTORI-TYYPPI	1. KK-LAAKERI-PARI	2. RK-LAAKERI-PARI	3. PÄITTÄIS-LAAKERIPARI	4. KK-HELA
361-2, 565, 500, 502, 504	310	<b>T5068</b> 836006501	<b>T5070 (b)</b> 836006671	<b>T5168A+T5169</b> 836010103+836112632	<b>T5093</b> 836006502
602, 612, 604, 604T	311C, CS	<b>T5069</b> 836110552	<b>T5072 (a)</b> 836119457	<b>T5171 (c)</b> 836119459	<b>T5094</b> 836110646
700,900,1100	411A	<b>T5069</b> 836110552		<b>T5172+T5169</b> 836110548+836112632	<b>T5094</b> 836110646
700, 702, 703, 802, 803	411B, C	<b>T5069</b> 836110552	<b>T5072 (a)</b> 836119457	<b>T5171 (c)</b> 836119459	<b>T5094</b> 836110646
702S, 903, 1102, 1103	411BS, CS	<b>T5069</b> 836110552	<b>T5072 (a)</b> 836119457	<b>T5171 (c)</b> 836119459	<b>T5094</b> 836110646
1203	411CX	<b>T5069</b> 836110552	<b>T5072 (a)</b> 836119457	<b>T5171 (c)</b> 836119459	<b>T5094</b> 836110646
205, 305, 405, 415	309D, DS	<b>T5068</b> 836006501	<b>T5070</b> 836006671	<b>T5169 (c)</b> 836112632	<b>T5093</b> 836006502
355, 455, 555	311D, DS	<b>T5069</b> 836110552	<b>T5072 (a)</b> 836119457	<b>T5171 (c)</b> 836119459	<b>T5094</b> 836110646
255, 355, 455, 555, 365, 465, 565, 6100	320D, DS	<b>T5069</b> 836110552	<b>T5072 (a)</b> 836119457	<b>T5171 (c)</b> 836119459	<b>T5269</b> 836646271
600, 700	320DE, DSRE	<b>T5069</b> 836110552	<b>T5072 (a)</b> 836119457	<b>T5171 (c)</b> 836119459	<b>T5269</b> 836646271
505, 605, 515, 615	311DS	<b>T5069</b> 836110552	<b>T5072 (a)</b> 836119457	<b>T5171 (c)</b> 836119459	<b>T5094</b> 836110646
705, 805, 655,715,815	411DS	<b>T5069</b> 836110552	<b>T5072 (a)</b> 836119457	<b>T5171 (c)</b> 836119459	<b>T5094</b> 836110646
665,865, 800,900	420D, DS 420DR, DRS	<b>T5069</b> 836110552	<b>T5072 (a)</b> 836119457	<b>T5171 (c)</b> 836119459	<b>T5269</b> 836646271
905,915	611D	<b>T5069</b> 836110552	<b>T5072 (a)</b> 836119457	<b>T5171 (c)</b> 836119459	<b>T5094</b> 836110646
6100	320DS	<b>T5069</b> 836110552	<b>T5072 (a)</b> 836119457	<b>T5171 (c)</b> 836119459	<b>T5269</b> 836646271
6000 6300, 6400 6250HI,6350HI	420D 420DS 420DSRE	<b>T5069</b> 836110552	<b>T5072 (a)</b> 836119457	<b>T5171 (c)</b> 836119459	<b>T5269</b> 836646271
6400,6600 6800	420DW 420DSI	<b>T5069</b> 836110552	<b>T5072 (a)</b> 836119457	<b>T5171 (c)</b> 836119459	<b>T5269</b> 836646271
6550HI,6650HI 6850HI	420DWRE 420DWRIE	<b>T5069</b> 836110552	<b>T5072 (a)</b> 836119457	<b>T5171 (c)</b> 836119459	<b>T5269</b> 836646271
8000, 8100 8050,8150 8050HI,8150HI	620D 620DS 620DSRE	<b>T5069</b> 836110552	<b>T5072 (a)</b> 836119457	<b>T5171 (c)</b> 836119459	<b>T5269</b> 836646271
8200 8550,8750,8800 8550HI 8950HI	634D 634DS 634DSRE 634DSBE	<b>T5069</b> 836110552	<b>T5072 (a)</b> 836119457	<b>T5171 (c)</b> 836119459	<b>T5269</b> 836646271
8400 8450 8350HI 8450HI	620DS 620DW 634DSRE 620DWRE	<b>T5069</b> 836110552	<b>T5072 (a)</b> 836119457	<b>T5171 (c)</b> 836119459	<b>T5269</b> 836646271
8300, 8600	612D, DS		<b>T5072 (a)</b> 836119457	<b>T5171 (c)</b> 836119459	<b>T5269</b> 836646271
A75n, A85n, A95n, T120, T130, T140, T160, T170		<b>T5069</b> 836110552	<b>T5072 (a)</b> 836119457	<b>T5171 (c)</b> 836119459	

a - asenna öljyreikälinen/-urallinen laakeriliuska sylinteriryhmään, sekä reiätön laakeriliuska laakerikanteen

b - ei sovi malleihin, jossa runkolaakeriin on integroitu päittäislaakerit

c - käytetään 2 paria / moottori

## Huom.

Venttiileiden istukkarenkaat  
katso Tarvikeluettelo T12



T1842

T5265

T5266

T5267

T5455

T5457

TRAKTORI-MALLI	MOOTTORI-TYYPPI	1. IMU-VENTTIILI	2. PAKO-VENTTIILI	3. VENTTIILIN OHJURI	4. SUUTTIMEN HOLKKI	5. O-RENGAS HOLKKIIN
33, 359, 361-1 361-2, 565, 500	310	<b>T5153</b> 836117564	<b>T5153</b> 836117564	<b>T5166</b> 836136051		
502, 504	310	<b>T5153</b> 836117564	<b>T5153</b> 836117564	<b>T5166</b> 836136051	<b>T5455</b> 836022081	<b>T5457 (a)</b> 614602415
602, 612, 604, 604T	311C, CS	<b>T5165</b> 836110153	<b>T5153</b> 836117564	<b>T5166</b> 836136051	<b>T5455</b> 836022081	<b>T5457 (a)</b> 614602415
700, 900, 1100		<b>T5165</b> 836110153	<b>T5153</b> 836117564	<b>T5166</b> 836136051		
702, 703, 802, 803	411B, C	<b>T5165</b> 836110153	<b>T5153</b> 836117564	<b>T5166</b> 836136051	<b>T5455</b> 836022081	<b>T5457 (a)</b> 614602415
702S, 903, 1102, 1103	411BS, CS	<b>T5165</b> 836110153	<b>T5153</b> 836117564	<b>T5166</b> 836136051	<b>T5455</b> 836022081	<b>T5457 (a)</b> 614602415
1203	411CX	<b>T5165</b> 836110153	<b>T5153</b> 836117564	<b>T5166</b> 836136051	<b>T5455</b> 836022081	<b>T5457 (a)</b> 614602415
205, 305, 405, 415	309D, DS	<b>T5435</b> 836529951	<b>T5436</b> 836529950	<b>T5166</b> 836136051	<b>T5455</b> 836022081	<b>T5457 (a)</b> 614602415
355, 455, 555	311D, DS →656315	<b>T5165</b> 836110153	<b>T5153</b> 836117564	<b>T5166</b> 836136051	<b>T5455</b> 836022081	<b>T5457 (a)</b> 614602415
255, 355, 455, 555, 365, 465, 565	320D, DS 656316→	<b>T5265</b> 836646356	<b>T5266</b> 836646357	<b>T5267</b> 836647601		
600, 700	320DE, DSRE	<b>T5265</b> 836646356	<b>T5266</b> 836646357	<b>T5267</b> 836647601		
665, 865 800, 900	420D, DS 420DSRE	<b>T5265</b> 836646356	<b>T5266</b> 836646357	<b>T5267</b> 836647601		
505, 605, 515, 615, 655	311DS	<b>T5165</b> 836110153	<b>T5153</b> 836117564	<b>T5166</b> 836136051	<b>T5455</b> 836022081	<b>T5457 (a)</b> 614602415
705, 805	411DS	<b>T5165</b> 836110153	<b>T5153</b> 836117564	<b>T5166</b> 836136051	<b>T5455</b> 836022081	<b>T5457 (a)</b> 614602415
715, 815	411DS	<b>T5165</b> 836110153	<b>T5153</b> 836117564	<b>T5166</b> 836136051	<b>T5455</b> 836022081	<b>T5457 (a)</b> 614602415
905, 915	611D	<b>T5165</b> 836110153	<b>T5153</b> 836117564	<b>T5166</b> 836136051	<b>T5455</b> 836022081	<b>T5457 (a)</b> 614602415
6100	320DS	<b>T5265</b> 836646356	<b>T5266</b> 836646357	<b>T5267</b> 836647601		
6000, 6300	420D, DS	<b>T5265</b> 836646356	<b>T5266</b> 836646357	<b>T5267</b> 836647601		
6400, 6600	420DS, DW	<b>T5265</b> 836646356	<b>T5266</b> 836646357	<b>T5267</b> 836647601		
6800	420DSI	<b>T5265</b> 836646356	<b>T5266</b> 836646357	<b>T5267</b> 836647601		
8000, 8100	620D	<b>T5265</b> 836646356	<b>T5266</b> 836646357	<b>T5267</b> 836647601		
8400	620DS	<b>T5265</b> 836646356	<b>T5266</b> 836646357	<b>T5267</b> 836647601		
8300, 8600	612D, DS	<b>T5227</b> 836328735	<b>T5228</b> 836328734	<b>T5166</b> 836136051	<b>T5455</b> 836022081	<b>T5457 (a)</b> 614602415
8200	634D	<b>T5265</b> 836646356	<b>T5266</b> 836646357	<b>T5267</b> 836647601		

a - o-renkaita tarvitaan 2 kpl / holkki

26.09.2011

TRAKTORI-MALLI	MOOTTORI-TYYPPI	TIIVISTE-SARJA täyd.	YLÄ-TIIVISTE-SARJA	KANNEN TIIVISTE	VENTTIILI-KANNEN TIIVISTE	ÖLJY-POHJAN TIIVISTE
361-2, 565, 500	310	<b>T5078</b> 836015738		<b>T5073</b> 836007586	<b>T5240</b> 836006565	<b>T5246</b> 836006704
502, 504	310B	<b>T5078</b> 836015738		<b>T5073</b> 836007586	<b>T5240</b> 836006565	<b>T5246</b> 836006704
602, 612, 604, 604T	311C, CS	<b>T5079</b> 836416917	<b>T5298</b> 836416916	<b>T5076</b> 836122443	<b>T5242</b> 836322898	<b>T5246</b> 836006704
700, 900, 1100	411A, AS	<b>T5080</b> 836130091	<b>T5157</b> 836130090	<b>T5074</b> 836122141	<b>T5241</b> 836107722	<b>T5247</b> 836107726
702, 703, 702S, 1102, 1103	411B, BS	<b>T5081</b> 836130093	<b>T5158</b> 836130092	<b>T5075</b> 836122104	<b>T5241</b> 836107722	<b>T5247</b> 836107726
702, 703, 802, 803, 903, 1102, 1103	411C, CS	<b>T5082</b> 836130370	<b>T5159</b> 836130369	<b>T5077 (a)</b> 836128125	<b>T5243</b> 836128134	<b>T5247</b> 836107726
1203	411CX	<b>T5083</b> 836130754	<b>T5160</b> 836130753	<b>T5077 (a)</b> 836128125	<b>T5243</b> 836128134	<b>T5247</b> 836107726
205, 305, 405, 415	309D, DS	<b>T5559</b> 836589066	<b>T5291</b> 836539065	<b>T5253</b> 836536630	<b>T5242</b> 836322898	<b>T5246</b> 836006704
355, 455, 555	311D, DS →656315	<b>T5571</b> 836431369	<b>T5294</b> 836439538	<b>T5076</b> 836122443	<b>T5242</b> 836322898	<b>T5246</b> 836006704
255, 355, 455, 555, 365, 465, 565	320D, DS 656316→	<b>T5560</b> 836640356	<b>T5293</b> 836640289	<b>T5251</b> 836655395	<b>T5244</b> 836646360	<b>T5246</b> 836006704
505, 605, 515, 615	311DS	<b>T5288</b> 836431973	<b>T5294</b> 836431368	<b>T5076</b> 836122443	<b>T5242</b> 836322898	<b>T5248</b> 836429729
665, 865, 800, 900	420D 420DR, DRS	<b>T5561</b> 836740333	<b>T5295</b> 836740280	<b>T5252</b> 836746354	<b>T5245</b> 836746362	<b>T5247</b> 836107726
705, 805, 655, 715, 815, 755, 855	411DS	<b>T5263</b> 836131371	<b>T5296</b> 836131370	<b>T5077 (a)</b> 836128125	<b>T5243</b> 836128134	<b>T5249</b> 836129728
905, 915	611D	<b>T5292</b> 836331748	<b>T5297</b> 836331747	<b>T5076 (x2)</b> 836122443	<b>T5242 (x2)</b> 836322898	<b>T5250</b> 836322183
6100	320DS	<b>T5562</b> 836640290	<b>T5293</b> 836640289	<b>T5251</b> 836655395	<b>T5244</b> 836646360	<b>T5248</b> 836429729
6000 6300, 6400 6250HI, 6350HI	420D 420DS 420DSRE	<b>T5563</b> 836740281	<b>T5295</b> 836740280	<b>T5252</b> 836746354	<b>T5245</b> 836746362	<b>T5249</b> 836129728
6400, 6600 6800 6550HI, 6650HI 6850HI	420DW 420DSI 420DWRE 420DWRIE	<b>T5563</b> 836740281	<b>T5295</b> 836740280	<b>T5252</b> 836746354	<b>T5245</b> 836746362	<b>T5249</b> 836129728
8000, 8100 8050, 8150	620D 620DS	<b>T5564</b> 836840238	<b>T5566</b> 836840237	<b>T5251 (x2)</b> 836655895	<b>T5244 (x2)</b> 836646360	<b>T5250</b> 836322183
8050HI, 8150HI	620DSRE	<b>T5564</b> 836840238	<b>T5566</b> 836840237	<b>T5251 (x2)</b> 836655395	<b>T5244 (x2)</b> 836646360	<b>T5250</b> 836322183
8200 8550, 8750 8550HI 8950HI	634D 634DS 634DSRE	<b>T5564</b> 836840238	<b>T5566</b> 836840237	<b>T5251 (x2)</b> 836655395	<b>T5244 (x2)</b> 836646360	<b>T5250</b> 836322183
8000, 8100 8050, 8150	620D 620DS	<b>T5564</b> 836840238	<b>T5566</b> 836840237	<b>T5251 (x2)</b> 836655395	<b>T5244 (x2)</b> 836646360	<b>T5250</b> 836322183
8050HI, 8150HI	620DSRE	<b>T5564</b> 836840238	<b>T5566</b> 836840237	<b>T5251 (x2)</b> 836655395	<b>T5244 (x2)</b> 836646360	<b>T5250</b> 836322183
8200 8550, 8750 8550HI 8950HI	634D 634DS 634DSRE 634DSBE	<b>T5564</b> 836840238	<b>T5566</b> 836840237	<b>T5251 (x2)</b> 836655395	<b>T5244 (x2)</b> 836646360	<b>T5250</b> 836322183
8400 8450 8350HI 8450HI	620DS 620DW 634DSRE 620DWRE	<b>T5564</b> 836840238	<b>T5566</b> 836840237	<b>T5251 (x2)</b> 836655395	<b>T5244 (x2)</b> 836646360	<b>T5250</b> 836322183
8300, 8600	612D, DS	<b>T5565</b> 836339671	<b>T5567</b> 836339296	<b>T5076 (x2)</b> 836122443	<b>T5242 (x2)</b> 836322898	<b>T5250</b> 836322183
A75n		<b>T5560</b> 836640356	<b>T5293</b> 836640289			
A85n, A95n		<b>T5561</b> 836740333				
T120, T130, T140 T160, T170 + C-mallit		<b>T5564</b> 836840238	<b>T5566</b> 836840237			

a - lisäksi tarvitaan o-renkaat **T5445** ja **T5446**

**G1.09**

Alkuperäisnumerot ovat ainoastaan vertailua varten, eivätkä tarkoituksenaan, että tuotteet ovat alkuperäisiä. Taulukoissa esiintyvät kuvat ovat viitteellisiä.

17.08.2007



T5084



T5085

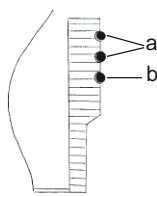

3 kpl  
o-renkaita/  
sylinteriputki



T5299

TRAKTORI- MALLI	MOOTTORI- TYYPPI	1. KAMPI- AKSELIN ETUTIIVISTE	2. KAMPI- AKSELIN TAKATIIVISTE	3. SYLINTERI- PUTKEN O-RENGAS YLEMPI	4. SYLINTERI- PUTKEN O-RENGAS ALEMPI
361-2, 565, 500	310	<b>T5084</b> 614105880	<b>T5085</b> 614400002	<b>T5299</b> 836038476	<b>T5299</b> 836038476
502, 503, 504	310B	<b>T5084</b> 614105880	<b>T5085</b> 614400002	<b>T5299</b> 836038476	<b>T5299</b> 836038476
602, 612, 604, 604T	311C, CS	<b>T5084</b> 614105880	<b>T5085</b> 614400002	<b>T5161</b> 835336903	<b>T5161</b> 835336903
700, 900, 1100	411A, AS	<b>T5084</b> 614105880	<b>T5085</b> 614400002		
702, 703, 702S, 903, 1102, 1103	411B, BS	<b>T5084</b> 614105880	<b>T5085</b> 614400002		
702, 703, 802, 803, 1102, 1103	411C, CS	<b>T5084</b> 614105880	<b>T5085</b> 614400002	<b>T5161</b> 835336903	<b>T5161</b> 835336903
1203	411CX	<b>T5084</b> 614105880	<b>T5085</b> 614400002	<b>T5161</b> 835336903	<b>T5161</b> 835336903
205, 305, 405, 415,	309D, DS	<b>T5084</b> 614105880	<b>T5085</b> 614400002	<b>T5299</b> 836038476	<b>T5299</b> 836038476
355, 455, 555	311D, DS	<b>T5084</b> 614105880	<b>T5085</b> 614400002	<b>T5161</b> 835336903	<b>T5161</b> 835336903
255, 355, 455, 555, 365, 465, 565	320D, DS	<b>T5084</b> 614105880	<b>T5085</b> 614400002	<b>T5290</b> 836647503	<b>T5290</b> 836647503
505, 605, 515, 615	311DS	<b>T5084</b> 614105880	<b>T5085</b> 614400002	<b>T5161</b> 835336903	<b>T5161</b> 835336903
655, 705, 805, 715, 815, 755, 855	411DS	<b>T5084</b> 614105880	<b>T5085</b> 614400002	<b>T5161</b> 835336903	<b>T5161</b> 835336903
905, 915	611D	<b>T5084</b> 614105880	<b>T5085</b> 614400002	<b>T5161</b> 835336903	<b>T5161</b> 835336903
6100	320DS	<b>T5084</b> 614105880	<b>T5085</b> 614400002	<b>T5290</b> 836647503	<b>T5290</b> 836647503
6000, 6300	420D, DS	<b>T5084</b> 614105880	<b>T5085</b> 614400002	<b>T5290</b> 836647503	<b>T5290</b> 836647503
6400, 6600	420DS, DW	<b>T5084</b> 614105880	<b>T5085</b> 614400002	<b>T5290</b> 836647503	<b>T5290</b> 836647503
6800	420DSI	<b>T5084</b> 614105880	<b>T5085</b> 614400002	<b>T5290</b> 836647503	<b>T5290</b> 836647503
8000, 8100	620D	<b>T5084</b> 614105880	<b>T5085</b> 614400002	<b>T5290</b> 836647503	<b>T5290</b> 836647503
8400	620DS	<b>T5084</b> 614105880	<b>T5085</b> 614400002	<b>T5290</b> 836647503	<b>T5290</b> 836647503
8300, 8600	612D, DS	<b>T5084</b> 614105880	<b>T5085</b> 614400002	<b>T5161</b> 835336903	<b>T5161</b> 835336903
8200	634D	<b>T5084</b> 614105880	<b>T5085</b> 614400002	<b>T5290</b> 836647503	<b>T5290</b> 836647503
8800	634DS	<b>T5084</b> 614105880	<b>T5085</b> 614400002	<b>T5290</b> 836647503	<b>T5290</b> 836647503

04.03.2011



## 7 hyvää syytä vaihtaa uudet suutinkärjet:

1. säästät polttoainetta
2. pidempi moottorin käyttöikä
3. puhtaammat päästöt
4. lisää tehoa
5. enemmän vääntöä
6. parempi käynnistyvyys
7. tasaisempi käynti



SD71329  
SD70070

TRAKTORI-MALLI	TUOTENO.	VERTAILU-NUMERO	VERTAILU-NUMERO	ALKUPERÄIS-NUMERO
33, 359, 361, 565-I, 565-II, 500, 502 504, 602, 604, 700, 702, 703, 900	SD70070	BDLL150S6429	5621260 CAV	836010936
602T, 604T, (311CS), 702S, 802, 803, 903, 1102, 1103, 1112, (411BS)	SD70015	BDLL150S6130A	5620790 CAV	836115244
880K, 1100, (411AS), 864, (411A) 1203, 1502, (611CS)	SD70015	BDLL150S6130A	5620790 CAV	836115244
205, 305, 405, 355, 415, 415M, 455 (→656315)	SD71329	DLLA150S1029	770671 Bo./Stan.	836339985 836339087
205, 305, 405, 355, 415, 415M, 455 (→656315)	SD71198	DLLA150S804	433271856 Bosch	835331101
255, 355, 455, 555, 365, 465, 565, 665 (656316→)	SD77920	DLLA150S620	770620 Stan.	836639957
355, 455, 555, 655, 755, 855, 505, 605, 705, 805, 615, 715, 815,	SD71198 (a)	DLLA150S804	433271856 Bosch	855331101
505, 605, 705, 805, 905, 655, 755, 855, 615M, 715M	SD71329 (b)	DLLA150S1029	770671 Bo./Stan.	836339985 836339087
6000, 6100, 6200, 6300, 6400, 6600, 6800	SD77920	DLLA150S620	770620 Stan.	836639957
8000, 8100, 8200, 8400, 8050, 8150, 8450, 8750	SD77920	DLLA150S620	770620 Stan.	836639957
865, 900, 8550	SD71329	DLLA150S1029	770671 Bo./Stan.	836339985 836339087
8050, 8450, 6250HI, 6550HI	SD779008	ADB145M34447	34447 Stan.	836854832

a - 4-reikäinen

b - 5-reikäinen

## ALUSLEVYT

### T0403

899901495

- koko 20 x 10 x 3
- 6 kpl/pussi.

### T0400

615570812

- ylivuotoputkeen (tarvitaan 2 kpl)



## HEHKUTULPAT

- sopii mm. vanha 100-, 02-,  
03-, 04-sarjoihin

### V565

- ruuviliittimellä

### MF0441

- lattaliittimellä



ks. sopivuudet G1.21

## VEDENEROTUSLASIT

### V298

- suodattimen alle
- sopii mm. 02-, 03-, 04-sarjoihin
- korkeus 54 mm, reiän halk. 25,4 mm

### T5113

- syöttöpumppuun Bosch
- sopii mm. 33, 359, 361

### Huom.

Täydelliset polttoainesuodattimet katso Tarvikeluettelo T12



## VEDENEROTIN TÄYDELLINEN

### F1711842A

836015104

- kierre ½ x 20 UNF
- sopii mm. vanha  
100-, 02-, 03-, 04-sarjoihin
- lasikupin tiiviste **V750**  
44 x 54 mm
- varalasi **V48/2**



G1.11

Alkuperäisnumerot ovat ainoastaan vertailua varten, eivätkä tarkoita, että tuotteet ovat alkuperäisiä.  
Taulukoissa esiintyvät kuvat ovat viitteellisiä.

22.10.2010

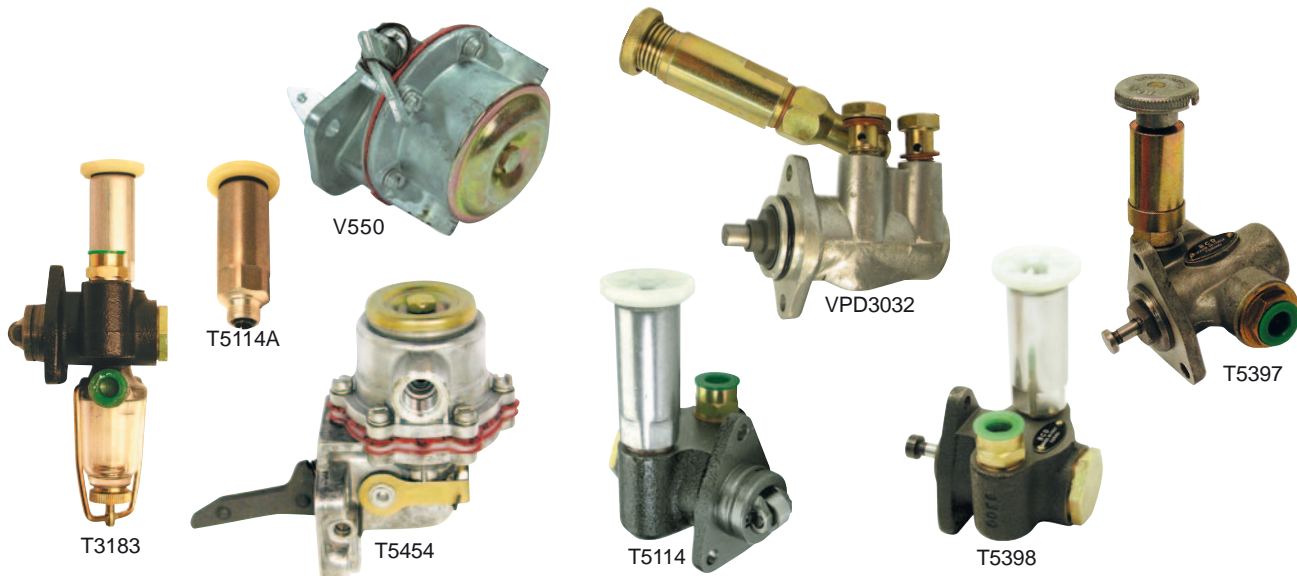

TRAKTORI-MALLI	SARJA-NUMERO	TIL.NRO	ALKUPERÄIS-NUMERO
33, 359, 361-1 361-2		T3183 (a) V550 (c)	836012114
565, 500, 602, 602T, 604, 604T, 700, 504, 702S		V550	836012114
502, 702		V550 VPD3032 (b)	836012114 836016055
702S, 703, 802, 803, 903		V550	836012114
900, 1100, 1102, 1103, 1203		V550	836012114
305, 405, 415, 415M	→77339	T5114 (d)	836439059, käyttövipu rissalla
205, 255, 305, 355, 365, 405, 455, 465, 555, 565, 415, 415M	77340→	T5398	836539872, käyttövipu tapilla
665		T5397	835340017
600, 700 (vm. 1998→)		T5398	836539872
505, 605, 615M	→77449	T5114	836431349, 836439059
505, 605, 615M	77450→	T5398	836539872, 836439059
705, 805, 715M	→77549	T5397	836131348, 836139012
655, 705, 755, 805, 855, 715M	77550→	T5397	835340017
905		T5397	835340017, 836131348
6100		T5398	836539872
6000, 6300, 6400, 6600, 6800, 8000, 8100, 8200, 8400		T5397	835340017, käyttövipu tapilla
8300, 8600, 8750		T5397	835340017
865, 800, 900, (vm. 1998→) 8050, 8150, 8450, 8550 A75N, A85N, A95N, 6250Hi, 6350Hi, 6550Hi, 6650Hi, 6750Hi, 6850Hi, 8050Hi, 8150Hi, 8350Hi, 8450Hi, 8550Hi		T5454	836659580, 836640932, 836659391 5-pultti kiinnitys

a - vain Bosch lasikupilla

b - "Import" Pal syöttöpumpulla olevat, käsipumppu VPD3299 (836016245)

c - vain Simss syöttöpumpun kanssa

d - käsipumppu T5114A (836007781), kierre M16 x 1,5 mm

## PYSÄYTINSOLENOIDI

### T5643

836662531

- A75 (P1001-), A85 & A95 (N19164-), Mezzo 6200 & 6300 (N19956-),  
Hi 6250 & 6350 (N19960-), C90, C100, C110, An-sarja, N91, N101 (-T07113),  
N111 (-T4003), A72, A82, A92, N82, N92



G1.12

Alkuperäisnumerot ovat ainoastaan vertailua varten, eivätkä tarkoita, että tuotteet ovat alkuperäisiä.  
Taulukoissa esiintyvät kuvat ovat viitteellisiä.



04.02.2008



TRAKTORI-MALLI	MOOTTORI-TYYPPI	PAKO-PUTKI	PAKO-PUTKEN TIIVISTE	PAKO-PUTKEN HATTU	PAKO-SARJA	TIIVISTE PAKO-SARJAAN	KIINNITYS-LAIPAN ASENTO °
33, 359, 361	310	T5054		VLD2054		T5286 (b) 836006805 T5287 (c) 836006804	
361-2, 565, 500	310B	T5055 658340		VLD2051	T5277 836012938	T5286 (b) 836006805 T5287 (c) 836006804	
502	310B	T5109 (d) 608331	T5303 822810	VLD2051		T5286 (b) 836006805 T5287 (c) 836006804	90°
602, 612	311C, CS	T5109 (d) 608331 T5538 (h) 621620	T5303 (d) 822810 T5304 (h) 586480	VLD2051		T5285 (x3) 836122886	90°
700, 900, 1100	411A, 411AS					T5286 (x2) 836006805	
702, 703	411B	T5109 (d) 608331	T5303 822810	VLD2051		T5286 (x2) 836006805	90°
702S, 703, 803, 903, 1102, 1103	411BS	T5110 (j) 608330		VLD2056		T5286 (x2) 836006805	15°
702, 703, 802, 803, 1102, 1103, 1203	411C, CS	T5110 (j) 608330		VLD2056		T5285 (x4) 836122886	15°
305, 405, 415, 415M	309D, DS →656315	T5300 (a) 31009310	T5304 586480	VLD2056		T5285 (x3) 836122886	90°
455, 555	311D, DS →656315	T5300 (a) 31009310	T5304 586480	VLD2056		T5285 (x3) 836122886	90°
365S, 455, 465, 465S, 555, 565, 355, 6100	320D, DS 656315→		T5306 32589800				90°
505, 605, 615, 655	311DS	T5301 (e) 30294920	T5304 586480	VLD2060		T5285 (x3) 36122886	90°
705, 715, 755, 805, 815, 855	411DS	T5301 (e) 30294920	T5304 586480	VLD2060		T5285 (x4) 36122886	90°
905, 915,	611D	T5302 (f) 30355700	T5305 (f) 30279900	VLD2056		T5285 (x6) 36122886	

a - sopii 305, 405, 415, 415M, 455, 555  
pyöreä laippa, kiinnitys neljällä pultilla, pulttipiiri 87 mm  
b - etummainen  
c - takimmainen  
d - kolmion mallinen laippa, kiinnitys kolmella pultilla, pulttipiiri 78 mm

e - pyöreä laippa, kiinnitys neljällä pultilla, pulttipiiri 87 mm  
f - suorakulmion mallinen laippa, kiinnitys neljällä pultilla 45 x 86 mm  
h - sopii 602 turbo, kiinnitys neljällä pultilla, pulttipiiri 87 mm  
j - neliön mallinen laippa, pulttipiiri 84 mm

## G1.13

Alkuperäisnumerot ovat ainoastaan vertailua varten, eivätkä tarkoituksena, että tuotteet ovat alkuperäisiä.  
Taulukoissa esiintyvät kuvat ovat viitteellisiä.

22.10.2010

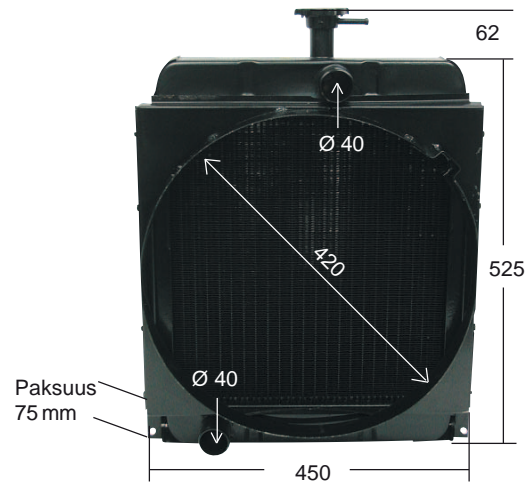
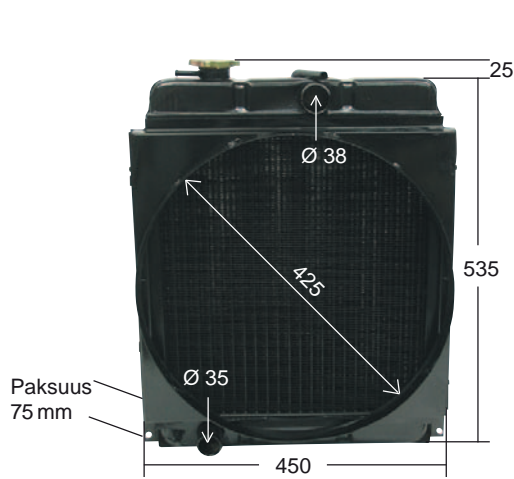

## JÄÄHDYTIN

### T5534

619302

- 502
- kokonaiskorkeus 560 mm
- sisältää tuulitunnelin 128 mm

## JÄÄHDYTIN

### T5535

30281700

- 205, 305, 405, 602, 602T, 612, 604, 604T
- (moottorityyppi 311C, CS)
- kokonaiskorkeus 587 mm
- sisältää tuulitunnelin 135 mm

**Muista uusia myös letkut ja letkunsiteet!**

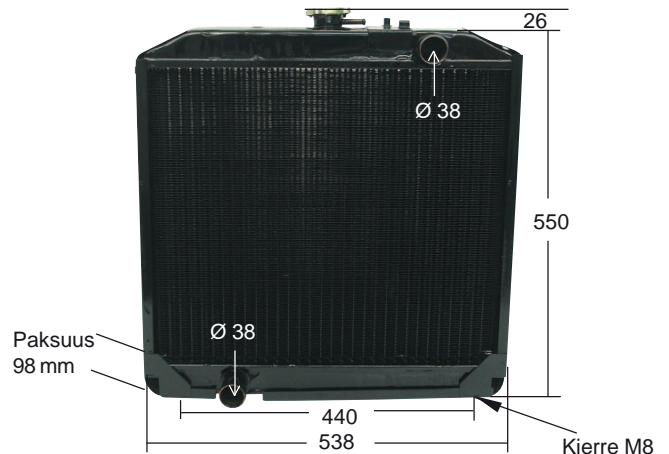
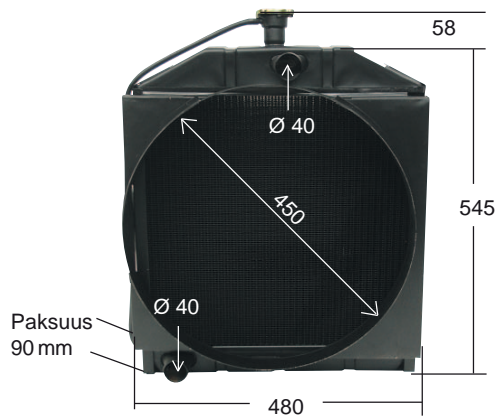

## JÄÄHDYTIN

### T5519

32611000

- 415, 355, 455, 555 (moottorityyppi 311D, DS)
- numerosta 656316→
- 255, 355, 455, 555, 365, 465, 565 (moottorityyppi 320D, DS)
- numerosta 656316→
- kokonaiskorkeus 603 mm
- sisältää tuulitunnelin 155 mm

## JÄÄHDYTIN

### T5517

30068900

- 505, 605, 515, 615, 655 (moottorityyppi 311DS)
- 705, 715, 755, 805, 815, 855 (moottorityyppi 411DS)
- kokonaiskorkeus 576 mm
- kiinnitysliipat takana, kokonaisleveys takaa 568 mm
- Huom! Sopiva korkki **T5644**

22.10.2010



T5376

T0028

T5105

T5108

T5471

TRAKTORI-MALLI	MOOTTORI-TYYPPI	JÄÄHDYTTIMEN KORKKI	YLÄVESI-LETKU	ALAVESI-LETKU	TIIVISTE vesip./term.
361-2, 500, 565	310D 310B	<b>T5376</b> 30247600	<b>T0026</b> 589310	<b>T0032</b> 619320	
502	310B	<b>T5376</b> 30247600	<b>T0028</b> (616790)(d) <b>T0030</b> (619311)	<b>T0032</b> 619320	<b>T5465</b> (b) 63114530
504,	310	<b>T5376</b> 30247600	<b>T0028</b> 616790	<b>T0032</b> 619320	<b>T5465</b> (b) 63114530
602, 602T, 612, 604, 604T	311C, CS	<b>T5376</b> 30247600	<b>T0028</b> 616790	<b>T5106</b> 616800	<b>T5465</b> (b) 63114530
700	411A, AS	<b>T5376</b> 30247600	<b>T0031</b> 672190	<b>T5107</b> 824580	
900	411A	<b>T5376</b> 30247600	<b>T5104</b> 824571	<b>T5107</b> 824580	
702, 703, 802, 803	411B, C	<b>T5376</b> 30247600	<b>T5102</b> 685160	<b>T5107</b> 824580	
702S, 903, 1102, 1103, 1203	411BS, CS	<b>T5376</b> 30247600	<b>T5104</b> 824571	<b>T5107</b> 824580	
205, 305, 405, 415,	309D, DS	<b>T5376</b> 30247600	<b>T0028</b> 616790	<b>T5106</b> 616800	<b>T5465</b> (b) 63114530
305, 405, 415, 355, 455, 555	311D, DS	<b>T5376</b> 30247600	<b>T0028</b> 616790	<b>T5106</b> 616800	<b>T5465</b> (b) 63114530
255, 355, 455, 555, 365, 465, 565	320D, DS	<b>T5376</b> 30247600	<b>T0028</b> 616790	<b>T5108</b> (c) 30107700	<b>T5466</b> (b) 614602550
665 865	420D 420DS	<b>T5376</b> 30247600			<b>T5466</b> (b) 614602550
505, 605, 515, 615, 655	311DS	<b>T5376</b> 30247600 <b>T5644</b> (e)	<b>T5105</b> 30107800	<b>T5108</b> 30107700	<b>T5471</b> (b) 836640848
705, 715, 755, 805, 815, 855	411DS	<b>T5376</b> 30247600 <b>T5644</b> (e)	<b>T5105</b> 30107800	<b>T5108</b> 30107700	<b>T5471</b> (b) 836640848
905	611D	<b>T5376</b> 30247600	<b>T5374</b> 30343500	<b>T5375</b> 30343400	
6100	320DS	<b>T5377</b> 31679810	<b>T5105</b> 30107800	<b>T5108</b> 30107700	<b>T5466</b> (b) 614602550
6000, 6200, 6300, 6400, 6600, 6800	420D, DS, DSI, DW	<b>T5377</b> 31679810	<b>T5105</b> 30107800	<b>T5108</b> 30107700	<b>T5466</b> (b) 614602550
6900, 8000, 8100, 8400	620D 620DS	<b>T5377</b> 31679810	<b>T5374</b> (a) 30343500	<b>T5108</b> 30107700	<b>T5467</b> (b) 614602950
8200	634D	<b>T5377</b> 31679810	<b>T5374</b> (a) 30343500	<b>T5108</b> 30107700	<b>T5467</b> (b) 614602950
8300, 8600	612D, DS	<b>T5377</b> 31679810			
8050, 8150, 8450, 8550, 8750	620DS 620DW 634DS				<b>T5467</b> (b) 614602950
600, 700, 800, 900	320D, DS 420DR, DRS	<b>T5376</b> 30247600		<b>T5108</b> 30107700	<b>T5466</b> (b) 614602550

a - →665753

c - 656316→

e - sopii jäähdyttimelle T5517

b - tarvitaan 2 kpl / traktori

d - kulma 45°, koko ø 38 mm

**G1.15**

Alkuperäisnumerot ovat ainoastaan vertailua varten, eivätkä tarkoituksenaan, että tuotteet ovat alkuperäisiä. Taulukoissa esiintyvät kuvat ovat viitteellisiä.



**T5400A**

836014271  
 - sopii: 361-2, 565, 500  
 - malleihin, joissa pumpun ja termostaattikotelon välissä ei ole putkea  
 - korjaussarja **T0025**



**T5400**

836055032  
 - sopii: 502, 504  
 - korjaussarja **T0025**



**T5404**

835339234  
 - sopii: 602, 612, 604, 702, 703, 802, 803  
 - korjaussarja **T0024**



**T5402**

836136220  
 - sopii: 505, 605, 515, 615, 655, 705, 755, 805, 855, 715, 815  
 - korjaussarja **T5412**

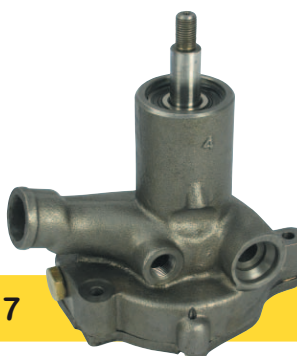

**T5617**

836124301  
 - sopii: 702S, 802, 803, 903, 1102, 1103 411BS ja 411CS moottorit



**T5406**

836864481  
 - sopii: 6900, 8050Hi, 8150Hi, 8050, 8150, 8000, 8100, 8200, 8400 (→L10225)  
 - korjaussarja **T5416**



**T5407**

836864484  
 - sopii: 8450Hi, 8550Hi, 8450, 8550, 8750

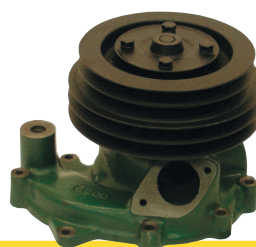

**T5539**

4774718-3  
 - sopii: 2005, 2105



**T5616**

836747847  
 - sopii: 6250Hi, 6350Hi, 6550Hi, 6650Hi, 6850Hi (→K6490)

**T5409**

836764215  
 - 6200 (K10201→), 6300 (K11155→), 6400 (K10176→), 6800 (K10683→), 6250Hi, 6350Hi, 6550Hi, 6650Hi, 6850Hi, A75N, A85N, A95N

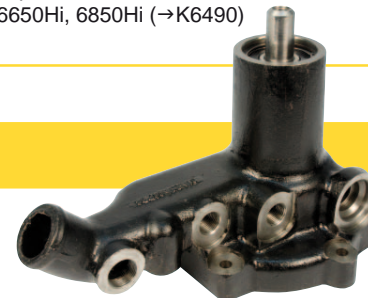

Sopii pumppuun  
 T5404  
 (835339234)

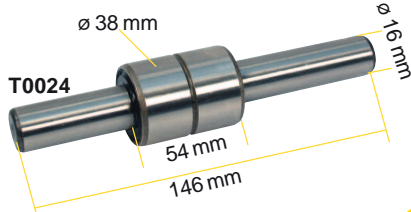

Sopii pumppuihin  
 T5400A,  
 T5400,  
 T5410A

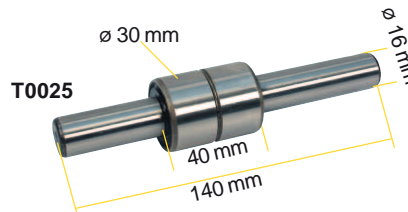

**G1.16**

22.10.2010

Katso tuuletin hihnojen  
vertailutaulukko  
Tarvikeluettelon sivulta T6.16c.

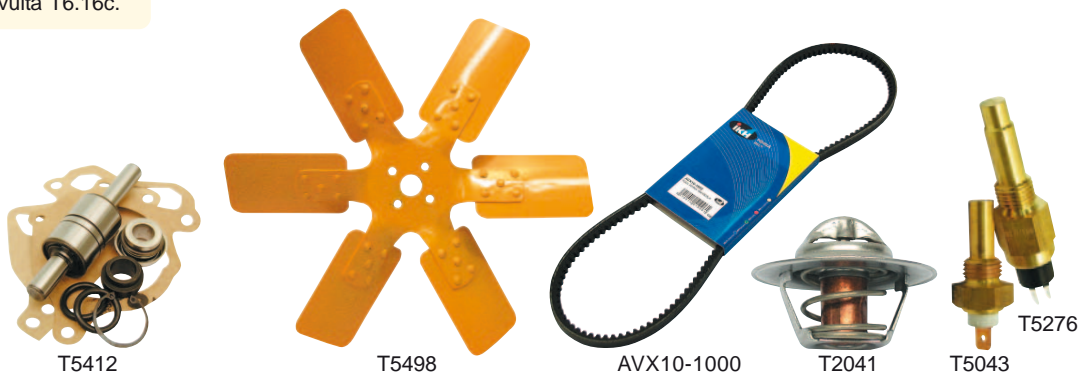

TRAKTORI-MALLI	MOOTTORI-TYYPPI	KORJAUS-SARJA	TUULET-TIMEN SIIVET	TUULET-TIMEN HIHNA	TERMOS-TAATTI	LÄMPÖ-MITTARIN ANTURI
361-1	310			KHB42		
361-2, 565, 500	310	T0025 836115971		AVX10-1100	T2041 (82°) 836115489	
502, 504	310	T0025 836115971		AVX10-1125	T2041 (82°) 836115489	T5043 619660
602, 612, 604, 604T	311C, CS	T0025 836115971		AVX13-1275 684121275	T2041 (82°) 836115489	T5043 619660
602, 612 604, 604T	311C, CS	T0024 (j) 836539064		AVX13-1275 684121275	T2041 (82°) 836115489	T5043 619660
700, 900, 1100		T0025 836115971		AVX10-1125	T2041 (82°) 836115489	
702, 703, 802, 803	411B, C	T0025 836115971		AVX10-1125 (f) AVX13-1075 (f) AVX13-1275 (f) AVX13-1325 (f)	T2041 (82°) 836115489	T5043 619660
702, 703 802, 803	411B, C	T0024 (j) 836539064		AVX10-1125 (f) AVX13-1075 (f) AVX13-1275 (f) AVX13-1325 (f)	T2041 (82°) 836115489	T5043 619660
702S, 903, 1102, 1103	411BS, CS	T5051 (h) 836115972		AVX10-1125 (f) AVX13-1075 (f) AVX13-1275 (f) AVX13-1325 (f)	T5434A (83°) 836666334 T5101 (80°)	T5043 619660
1203				AVX13-1325 684121235	T5434A (83°) 836666334 T5101 (80°)	T5043 619660
205, 305, 405, 415	309D, DS	T5415 (d) 836539064 T5412 (e) 835331372		AVX13-1275 684121275	T2041 (82°) 836115489	T5276 654271208
355, 455, 555	311D, DS	T5415 (d) 836539064 T5412 (e) 835331372		AVX13-1275 684121275	T2041 (82°) 836115489	T5276 654271208
255, 355, 455, 555, 365, 465, 565	320D, DS	T5415 (d) 836539064 T5412 (e) 835331372		AVX13-1275 684121275	T5434A (83°) 836666334 T5101 (80°)	T5276 654271208
505, 605, 515, 615, 655	311DS	T5412 835331372	T5498 (k) 836119431	AVX13-1325 684121325	T5434A (83°) 836666334 T5101 (80°)	T5276 654271208
705, 755, 805, 855 715, 815	411DS	T5412 835331372	T5498 (k) 836119431	AVX13-1325 684121300	T5434A (83°) 836666334 T5101 (80°)	T5276 654271208
905, 915	611D	T5414 836316441		AVX13-1425 684121425	T5432 (83°)(g) 836331590	T5276 654271208

k - halkaisija 430 mm, siipiä 6 kpl, keskireikä 25 mm, pulttipiiri 53 mm, 4 pulttia  
Katso muut huomautukset seuraavalta sivulta

22.10.2010

Katso tuulettimen hienojen vertailutaulukko Tarvikeluettelon sivulta T6.16c.



TRAKTORI-MALLI	MOOTTORI-TYYPPI	KORJAUS-SARJA	TUULETTIMEN HIHNA	TERMOSTAATTI	LÄMPÖMITTARIN ANTURI
6100	320DS	<b>T5412</b> 835331372	<b>AVX13-1325</b> 684121325	<b>T5434A</b> (83°) 836115718 <b>T5101</b> (80°)	<b>T5276</b> 654271208
6000, 6300	420D, DS	<b>T5412</b> 835331372	<b>AVX13-1325</b> 684121325	<b>T5434A</b> (83°) 836115718 <b>T5101</b> (80°)	<b>T5276</b> 654271208
6400, 6600	420DS, DW	<b>T5412</b> 835331372	<b>AVX13-1325</b> 684121325 <b>AVX13-1300</b> (a) 684121300	<b>T5434A</b> (83°) 836115718 <b>T5101</b> (80°)	<b>T5276</b> 654271208
6800	420DSI	<b>T5051</b> (h) 836115972	<b>AVX13-1300</b> (x2) 684121300	<b>T5434A</b> (83°) 836115718 <b>T5101</b> (80°)	<b>T5276</b> 654271208
8000, 8100	620D	<b>T5416</b> 836840101	<b>AVX13-1400</b> (x2) 684121400	<b>T5434A</b> (83°) 836115718 <b>T5101</b> (80°)	<b>T5276</b> 654271208
8400	620DS →G13500	<b>T5416</b> 836840101	<b>AVX13-1400</b> (x2) 684121400	<b>T5434A</b> (83°) 836115718 <b>T5101</b> (80°)	<b>T5276</b> 654271208
8050, 8150, 8400	620DS G13501→	<b>T5416</b> 836840101	<b>AVX13-1400</b> (x2) 684121400	<b>T5432</b> (83°)(g) 836331590	<b>T5276</b> 654271208
8300, 8600	612D, DS	<b>T5417</b> 836339723	<b>AVX13-1600</b> (c) 684121600	<b>T5432</b> (83°)(g) 836331590	<b>T5276</b> 654271208
8200	634D	<b>T5416</b> 836840101	<b>AVX13-1400</b> 684121400	<b>T5434A</b> (83°) 836115718 <b>T5101</b> (80°)	<b>T5276</b> 654271208

a - 6600 E1233→

b - E7055→

c - hihnasarja

d - 205-555 →656315

e - 255-655 656316→

f - **AVX10-1125** = 10 x 1125

**AVX13-1075** = 13 x 1075

**AVX13-1275** = 13 x 1275

**AVX13-1325** = 13 x 1325

g - kahdella termostaattilla

h - siivapyörän kiinnitys akseliin mutterilla, ei sisällä akselia

j - sopii pumppuun 835339234 (T5404)

## COMBITIIVISTE

### T0025A

835339425

- vesipumpun akselille, sama tiiviste kuin korjaussarjassa
- halkaisija 36,6 mm (A)
- reikä 15,8 mm

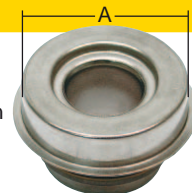

**G1.18**

26.09.2011

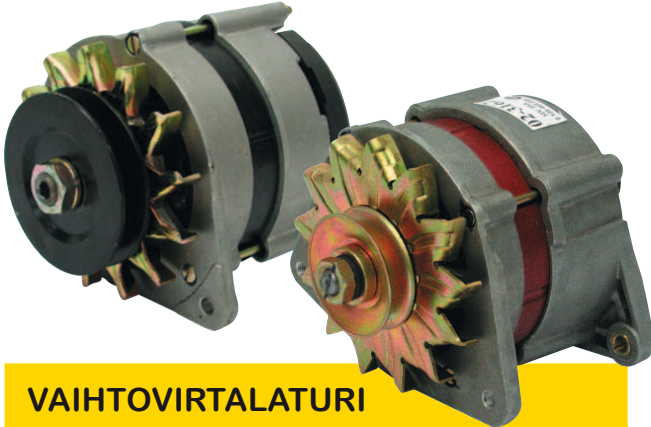

## VAIHTOVIRTALATURI

- sisältävät tuulettimen ja siivan

### ST0215

835339304

- 505, 605, 705, 805, 905, 615, 715, 655, 755, 855
- w-liittimellä sähkö kierroslukumittarille
- teho 70 A
- akselin koko 15 mm
- hihnaura 12,5 mm

### ST0232

836640128

- 5-napainen
- 600, 700, 800, 900 -> J6773, 865, 6000, 6100, 6300, 6400, 6600, 6800, 8000, 8100, 8200
- teho 70 A
- akselin koko 17 mm
- hihnaura 12,5 mm

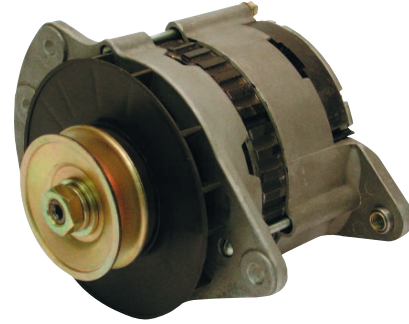

## VAIHTOVIRTA-LATURI 65 A

### ST0210

- 5-napainen
- yleismalli, sisältää tuulettimen ja siivan
- soveltuu useimpien 12 V järjestelmien 28-65 A tehoisten latureiden tilalle
- w-liittimellä sähkö kierroslukumittarille
- hihnaura 13,5 mm



## LATURI 95A

### ST0239

836640927, 836666225, 836666720

- Valmet
- 6100, 6300, 6400, 6600, 6800, 8050, 8150, 8400, 8450, 8550, 8750, A75, A85, A95
- 4-napainen
- w-liittimellä sähkö kierroslukumittarille
- akselin halkaisija 17 mm
- kiinnityskorva 56 mm/29 mm



## LATURI 120A

### ST0240

836666039, 836666226, 836666721

- Valmet
- 8450, T120, T130, T140, T160, T170
- 4-napainen
- w-liittimellä sähkö kierroslukumittarille
- akselin halkaisija 17 mm
- kiinnityskorva 56 mm/29 mm

## VAIHTOVIRTALATURI 45 A

### ST0005

835339303







- 18 ACR
- teho 630W
- jännitteen säädin ST0005-10
- 502, 503, 504, 602, 604, 702, 703, 802, 803, 902, 903, 1102, 1103, 1203, 1502
- 656316->: 255, 355, 365, 455, 465, 555, 565, 665

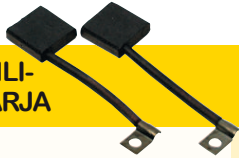

**G1.19**

26.09.2011

## PIKKULUCAS TASAVIRTALATURI, VALMET 361, 565, 500 ja 502

			
<b>LATURI</b>	<b>HIILI-SARJA</b>	<b>VETOPÄÄTY</b>	<b>VETOPÄÄN LAAKERI</b>
ST0001	ST0013	ST0012	L6302-2RS
			
<b>HIILIPÄÄN PUSLA</b>	<b>SIIVAPYÖRÄ</b>	<b>RELE</b>	<b>RELE</b>
ST0016	ST0009	ST0082	ST0084

## LUCAS 18 ACR VAIHTOVIRTALATURI

02, 03 ja 04 sarjat

					
<b>LATURI 18 ACR</b>	<b>HIILISARJA</b>	<b>SÄÄDIN</b>	<b>DIODISILTA</b>	<b>SIIVA-PYÖRÄ</b>	<b>LIITIN-SARJA</b>
<b>ST0005</b> 835339303	<b>ST0024</b> 836115425	<b>ST0020</b> 836115797	<b>ST0021</b> 836115798	<b>ST0022 (a)</b> <b>ST0022B (b)</b>	<b>ST0025</b>

a - halkaisija 63 mm, ura 9,5 mm

b - halkaisija 90 mm, ura 12,5 mm

## CAV CA 45 STARTTIMOOTTORIN VARAOSAT

VALMET 361 D, 565

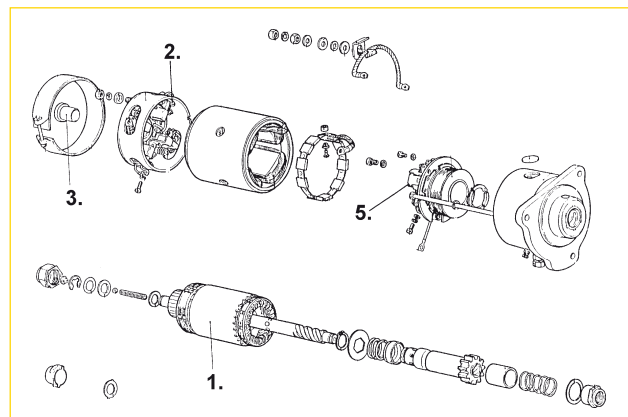

### Huom.

Katso startin tyyppi tilatessasi varaosia



6. ST0053

TYYPPI	1. ANKKURI	2. HIILI-SARJA	3. HELA-SARJA	5. SOLENOIDIN KÄRJET KIINTEÄ + LIIKKUVA	6. SOLENOIDI KAAPELIN VÄLIIN
CA 45 C	ST0063	ST0065 (a)	ST0066		ST0053
CA 45 D	ST0063	ST0065 (a)	ST0066	ST0072	ST0053

a - 9 x 20 mm, pituus 25,5 mm

**G1.20**

Alkuperäisnumerot ovat ainoastaan vertailua varten, eivätkä tarkoita, että tuotteet ovat alkuperäisiä. Taulukoissa esiintyvät kuvat ovat viitteellisiä.



04.03.2011

## Huom.

Katso startin ST0036A varaosat Tarvikeluettelo T2

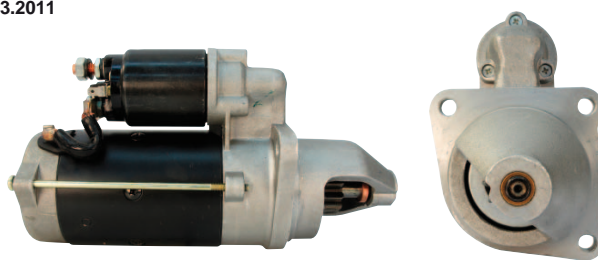
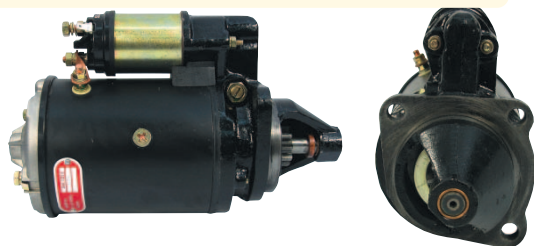

## STARTTI

### ST0231

- 8300, 8600

## STARTTI

### SM2834A (836640949)

- 1100, 1102, 1103, 1203, 205, 305, 33, 355, 359, 361, 405, 455, 500, 502, 504, 505, 565 (-64-68), 600, 6000, 602, 604, 605, 6100, 6300, 6400, 655, 6600, 6800, 700, 702, 703, 705, 755, 800, 8000, 802, 803, 805, 8100, 8200, 8400, 855, 900, 903, 905, T120, T130, T140e, T160, T170, T180, T190 -> N17488, A75, A85, A95

## STARTTI

### ST35210 (835331592, 133200009075)

- 33, 359, 361, 565, 500, 600, 700, 800, 900, 1100, 502, 504, 602, 604, 702, 703, 802, 803, 903, 1102, 1103, 1203, 205, 305, 405, 505, 605, 705, 805, 905, 355, 455, 655, 755, 855, 6000, 6100, 6300, 6400, 6600, 6800, 8000, 8100, 8400, 8200  
- 12 V  
- 4,0 kW  
- 11 hammasta  
- LRS 147

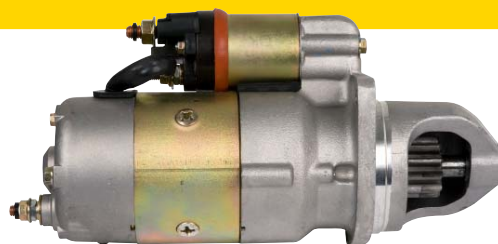

TRAKTORI-MALLI	HIILI-SARJA	BENDIX-RATAS	HELA-SARJA	VIRTA-LUKKO	KÄYNNISTYS-RELE	HEHKUTULPPA ruuvi-liitt.	HEHKUTULPPA latta-liitt.
500, 700, 900, 1100	ST0048 836015230	ST0186 (a) 836015831	ST0051 836015848	ST0087 816450		V565 836115179	MF0441
502, 504, 602, 604, 702, 703, 802, 803, 903, 1102, 1103, 1203	ST0048 836015230	ST0186 (a) 836015831	ST0051 836015848	ST0087 816450 32553200	ST0177 687300	V565 836115179	MF0441
505, 605, 655, 755, 855, 705, 805, 905		ST0226 (a)		ST0178 30100800	T5371 30101000	V565 836115179	MF0441
205-655				ST0087 816450	ST0177 687300	V565 836115179	MF0441
6000, 6100, 6300, 6400, 6800, 8000, 8100, 8200, 8400		ST0226 (a)		ST0087 32553200		V565 836115179	MF0441

a - Lucas

## STARTTIKEHÄ

### T5547

(836117970, 836014127)

- sisä Ø 357 mm, Z 128  
- 502, 602, 503, 205, 305, 405, 415, 415M, 355, 455, 555, 565 uusi, 665, 865, 512, 612, 600, 700 uusi, 800, 900 uusi



## STARTTIKEHÄ

### T5546

(835328783, 836117378)

- sisä Ø 373 mm, Z 133  
- 702-1502, 703-1203, 505-905, 715-915, 755-955, 6000-6900, 6250Hi-6850Hi, 8000-8950, 8050Hi-9050Hi, 712, 812, 912, 1112

05.02.2010



TRAKTORI- MALLI	KYTKIMEN PÄÄSYLINTERI		PÄÄSYLINTERIN KORJAUSSARJA		KYTKIN- JA JARRUNESTE- SÄILIÖ	KYTKIMEN TYÖ- SYLINTERI	KYTKIMEN TYÖ- SYLINTERIN KORJAUSSARJA
	ALU	VALU	ALU	VALU			
700, 702, 703, 802, 803, 903	<b>T0310</b> 661910	<b>T0311</b> 661911	<b>T5002</b> (a) 663240	<b>T5003</b> (b) 663241	<b>T5001</b> 813140	<b>T5011</b> 666230	<b>T5012</b> (c) 691210
900, 1100, 1102, 1103, 1203	<b>T0310</b> 661910	<b>T0311</b> 661911	<b>T5002</b> (a) 663240	<b>T5003</b> (b) 663241	<b>T5001</b> 813140	<b>T5011</b> 666230	<b>T5012</b> (c) 691210
6000, 6100, 6300, 6400, 6600, 8000, 8100, 8200, 8400		<b>T5282</b> 33031410		<b>T5283</b> 31975300			
N91C, N101C, N111C		<b>T5282</b> 33031410					
T120C, T130C, T140C, T150C, T160C, T170C		<b>T5288</b>					
T121C, T131C, T161C, T171C		<b>T5288</b>		<b>T5283</b> 31975300			

a - vaihtoehto T5002A

b - vaihtoehto T5003A

c - vaihtoehto T5012A

26.09.2011



LUK133060510

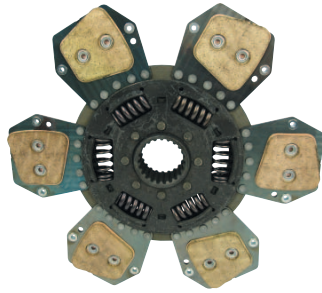

LUK331010411

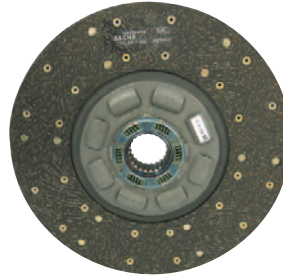

LUK333020110



T5280



L6205-2RSC3

TRAKTORI-MALLI		KYTKIN-ASETELMA	KYTKIN-LEVY	PAINELAAKERI/HIILI	SILMÄ-LAAKERI
33, 359, 361, 361-2, 565	280 mm	T5033 (3) 584400	T5129 (e) 584520	LUK500059011 584310	L6205-2RSC3
500, 502, Valtra 542, 2402	280 mm	T5033 (3) 584400	LUK328024810 T5129 (e) V8740 584520	LUK500059011 584310	L6205-2RSC3
700, 702, 703, 712, 912, 900, 1100, 1102	310 mm	T5031 (3)	T5032 813890	T5453 725160	L6304-2RSC3 LA1282
Valtra UM 353, UM 355, UM 475, UM 855	310 mm	T5031 (3)	T5032 813890	T5453 725160	L6304-2RSC3 LA1282
205	280 mm		T5212 30960900	31257400	L6304-2RSC3 LA1282
505, 605, 705, 805 Orgaani	310 mm	LUK133060510 (d, 3) 30342900	LUK331026910 (c, k) T5029S (c, k) 30049210 LUK331010411 (c, g) 30049300	T5280 30208100	L6008-2RSC3 LA1992
505, 605, 655, 705, 755, 805, 855, 905	330 mm	LUK133060510 (3) 30342900	LUK333020110 (b, c) T5177S 32592700 LUK333020111 (c, g) T5177S 32772900	T5280 30208100	L6008-2RSC3 LA1992
Volvo 2005, 2105,	380 mm		T5163 (b) T5164 (a) 4832414		
6000, 6100, 6200, 6300, 6400, 6600, 6800, 6900, 8000, 8100, 8200, 8400	330 mm	LUK133060510 (3) 30342900	LUK333008110 (b, i) T5177 (b, i) 31887800 LUK333020110 (b, c, h) T5177S (c, h) 32592700 LUK333020111 (c, g, h) 32772900	T5280 30208100 LUK510002110 (f, l) 31597300	L6008-2RSC3 LA1992
8200, 8400 (663387→) 8050, 8150, 8450, 8550, 8750 T120c, T130c, T140ec T160c, T170c	350 mm	LUK136021310 (3) 32831400	LUK335031710 32831300 35651400	LUK510002110 (f, l) 31597300	L6008-2RSC3 LA1992
505, 605, 655, 705, 755, 805	330 mm		LUK333020111 (c, g) 32772900		

a - T5164 vahvistettu levy Intercooler-mallit

b - orgaaninen

c - jousitetulla keskiöllä

d - 330 mm kytkin voidaan asentaa 310 mm kytkimen tilalle suoraan

e - T5129 kudottu HD

f - hydraulinen malli, sis. sylinterin

g - keraaminen

h - malleihin, joissa on perinteinen kytkin

i - malleihin, joissa on turbiinikytkin

3 - ei sisällä levyä

k - 310 mm

l - kasviöljypohjaiselle kytkinnesteelle

**G1.23**

26.09.2011

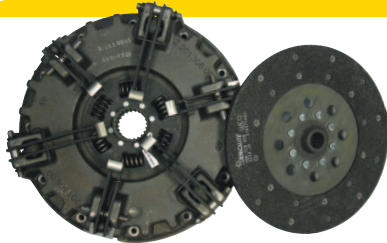

LUK630303309



LUK228008710



L6304-2RSC3



LUK228009110

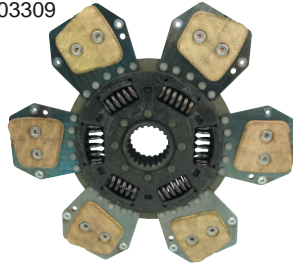

LUK331010411

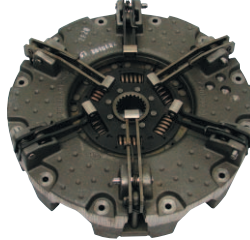

LUK231010210

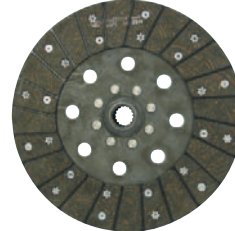

LUK328025110



T5452



T5450

TRAKTORI-MALLI		KYTKIN-ASETELMA	AJO-KYTKIN-LEVY	VO-KYTKIN-LEVY	AJO-PAINE-LAAKERI	VO-PAINE-LAAKERI	SILMÄ-LAAKERI
565, 500, 502, 700, englantilainen kytkin (peltiaset.)	280 mm	LUK228008710 (1) 654490	LUK328024310 T5024 654410	V8811 654420 LUK328024210 (a)	T5448 654390	T5449 (1) 654310	L6304-2RSC3 LA1282
502, 504, 602, 604 Valtra C612 saksalainen kytkin (valuaset.)	280 mm	LUK228015910 (1) 601450	T5025 721155	LUK328024210 (a) T4092 (a) LUK328045210 (b)	T5450 582990	T5451 582970	L6304-2RSC3 LA1282
602 T 604 T	280/280	LUK228015910 (m,1) 601450	T5027 (f) 721275	LUK328024210 (a) LUK328045210 (b) T4092 (a)	T5450 582990	T5451 582970	L6304-2RSC3 LA1282
700, 702, 703, 702 S, 802, 803, 900, 903, Valtra 742, 942 1100, 1102, 1103, 1203	310 mm	LUK231010210 (s,1) 664880	LUK331010411 (n) T5030 (n) 723554 LUK331026910 (c, m) 331026910 T5029S (c, m) 30049210 T5029 (m) 30049200	LUK331027010 (s) 814050	T5452 (v) 811080 T5035 (u) 725150	T5453 725160 663120	L6304-2RSC3 LA1282
465, 555, 565, 665 (→F14302)	280/280	LUK228009110 (n,1) 32043110	LUK328025210 (f) T5212 (h) 32639400	LUK328025110 32043000	T5450 582990	T5451 582970	L6304-2RSC3 LA1282
255, 305, 355, 365, 405, 455, 465, 555, 565, 665, 865 (F14303→) 600, 700, 800, 900	295/280	LUK630303309 (1,2) LUK630303319 (1,2, d, n) 34548900	T5447 (i, r) 33294700	LUK328025110 (f) 30960710	T5450 582990	T5451 582970	L6304-2RSC3 LA1282
A65, A75, A85, A95	295/280	LUK630303309 (1,2) LUK630303319 (1,2, d, n) 34548900	T5447 (f) 33294700	LUK328025110 (f) 30960710	T5450 582990	T5451 582970	LA1803
A75n, A85n, A95n	295/280	LUK630303309 (1,2) LUK630303319 (1,2, d, n) 34548900	T5447 (f) 33294700	LUK328025110 (f) 30960710	T5450 582990	T5451 582970	LA1803
8300, 8600 parikytkin	310/310	T5468 (n, 1) F35809442	T5469 (j) F35809462				

- a - 10-poorinen
- b - 18-poorinen
- c - **T5029S** keskiö jousitettu
- d - 7-lapainen
- f - keraaminen 280 mm
- h - orgaani jousitettu 280 mm
- i - orgaani jousitettu 295 mm numerosta F14303→
- j - tarvitaan 2 kpl / traktori
- m - orgaani
- n - keraaminen
- p - HD-malli (sopii ainoastaan jos käyttää painelaakerin ohjainta HD-mallia)
- r - sopii vain F&S-kytkimiin
- s - myös VO-levy/asetelma uusittava
- t - K57,40, Ø 111,40 mm, Ø 133 mm
- u - K56, Ø 112 mm, Ø 159,70 mm
- v - K54, Ø 112 mm, Ø 159 mm
- 1 - sisältää ajolevyn
- 2 - sisältää VO-levyn

## KESKIÖRASVA

### LUK414001410

- erityisesti kytkin keskiöihin ja -akseleihin



## VAUHTIPYÖRÄN NAPA

### LUK370005210

35652400

- T120, T130, T140, T150, T160, T170, T180, T190, 8050Hi, 8150Hi, 8350Hi, 8450Hi, 8550Hi, 8950Hi

26.09.2011

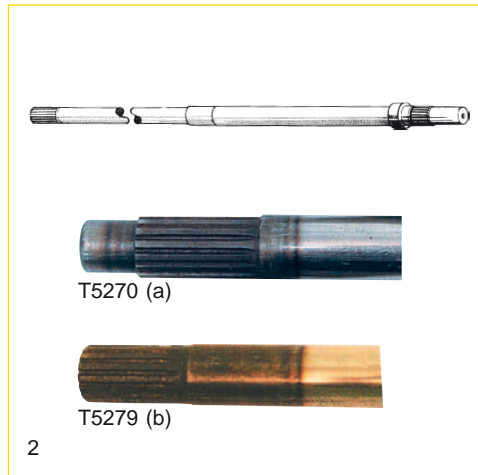
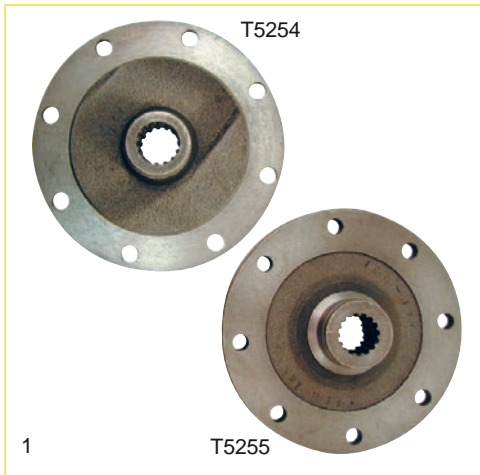

TRAKTORI-MALLI	1. VAUHTI-PYÖRÄN POORIKAPPALE	2. V.O PITKÄ KÄYTTÖ-AKSELI	3. V.O TUKI-LAAKERI
505, 605, 705, 805, 905, 815, 915, 655	<b>T5254</b> (a, d) 30021810 halkaisija 168 mm <b>T5255</b> (b, d) 30021820 halkaisija 176 mm	<b>T5270</b> (a) 30014500 pituus 2413 mm <b>T5279</b> (b) 30014510 pituus 2408 mm	<b>T5038</b> LA9011
6000, 6100, 6300, 6400, 6600, 6800, 8000, 8100, 8200, 8400	<b>T5255</b> 30021820		
8050Hi, 8150Hi, 8350Hi, 8450Hi, 8550Hi, 8950Hi, T120, T130, T140, T150, T160, T170, T180, T190	<b>LUK370005210</b> 35652400		

- a - sarjanumeroon →605677
- b - sarjanumerosta 605678→
- c - ks. silmälaakeri kytkinsivulta
- d - malleihin, joissa perinteinen kytkin

### KYTKINAKSELI SISIN

**T5612**  
671630  
- 702, 703, 803, 903

### KYTKIN-AKSELI

**T5618**  
651862  
- 502  
- kaksoiskytkimellä  
- 10/12 uraa

### KYTKIN-AKSELI

**T5619**  
605890  
- 602  
- 10/12 uraa

### OHJAUSHOLKKI

**T5650**  
820430  
- 702, 703, 802, 803, 903

**G1.25**

04.03.2011

## VETOAKSELI TÄYDELLINEN



### T5620

30402810

- sopii -05 sarjat, joissa Carraro 709/20 etuakseli

## VETOAKSELIN URAHOLKKI



### T5588

717380

- sopii 702, 703, 803, 903

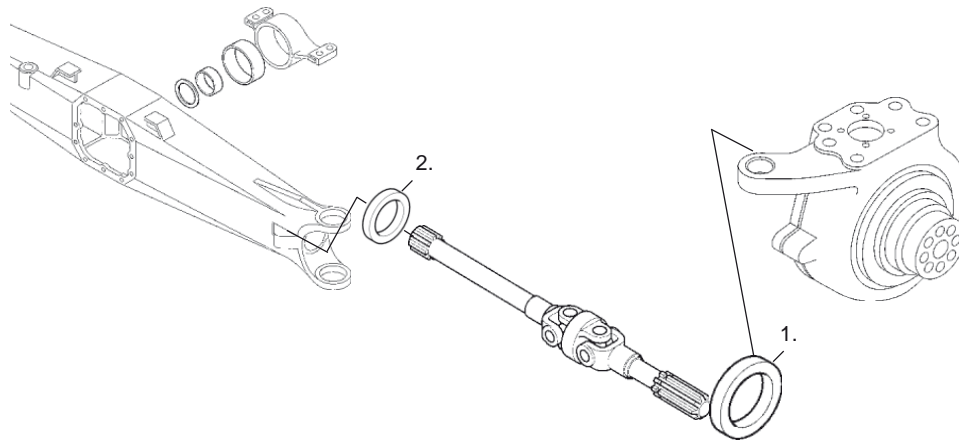

TRAKTORI-MALLI	ETUAKSELI	VETOAKSELIN TIIVISTE 1. ULOMPI	2. SISEMPI	ETUNAVAN ISO TIIVISTE	KARDAANIN ETUP. TIIVISTE
205, 305, 355, 405, 455, 555, 415, 415M	ZF APL 335	<b>F3959483</b> (d) 31372000	<b>F3959483</b> (d) 31372000	<b>F1869544</b> (e) 31062710	<b>F3945747</b> 31370300
255, 355, 365, 455, 465, 555, 565, 665, 865	SIGE 658483→	<b>T56026</b> 31800500	31953100	<b>T56025</b> 31795910	<b>T56030</b> (b) <b>OAS609010</b> (c) 31794200
600, 700, 800 900	SIGE	<b>T56026</b> 31800500	31953100	<b>T56025</b> 31795910	<b>T56030</b> (b) <b>OAS609010</b> (c) 31794200
505, 605, 705, 805, 905, 615M, 715M	709/20	<b>F3949435</b> KH1209	<b>F3952335</b> KH1213	<b>T56023</b> KH1214	<b>F3949435</b> KH1209
505, 605, 705, 805, 905, 615M, 715M	AE3	<b>F3930306</b> KH1163	<b>F3930307</b> KH1161	<b>T56021</b> KH1158	<b>VPJ2877</b> KH1162
505, 605, 705, 805, 905, 615M, 715M	AE3 VEA/302→	<b>F3946626</b> KH1216	<b>F3930307</b> KH1161	<b>T56022</b> KH1215	<b>T56029</b> KH1211
505, 605, 655, 705, 755, 805, 855, 905, 615M, 715M	SIGE	<b>T56026</b> 31800500	<b>T56027</b> 31790500 31790510	<b>T56024</b> 31795900	<b>T56030</b> (b) <b>OAS609010</b> (c) 31794200
6000, 6100, 6200, 6300, 6400, 6600, 6800, 6900, 8000, 8100, 8200, 8400, 6250HI, 6350HI, 6550HI, 6650HI	SIGE	<b>T56026</b> 31800500	<b>T56027</b> 31790500 31790510	<b>T56025</b> 31795910	<b>T56030</b> (b) <b>OAS609010</b> (c) 31794200
6600, 6800, 6900, 8100, 8200, 8400, 6650HI, 6850HI, 8050HI, 8350HI, 8450HI, 8550HI, 8950HI, 8050, 8100, 8100, 8450, 8550, 8750	SIGE IND	<b>T56028</b> 31800610	<b>T56026</b> 31800500	<b>T56024</b> 31795900	
6650HI, 6850HI, 8050HI, 8150HI, 8350HI, 8450HI, 8550HI, 8950HI	CARRARO IND	34052100	<b>F3946626</b> KH1216	34051900	

a - 33248→

c - etummainen

e - 13,5 x 122 x 150 mm

b - takimmainen

d - 65,22 x 46,08 x 17,05 mm

## G1.26

Alkuperäisnumerot ovat ainoastaan vertailua varten, eivätkä tarkoita, että tuotteet ovat alkuperäisiä.  
Taulukoissa esiintyvät kuvat ovat viitteellisiä.

04.03.2011



TRAKTORI-MALLI	ETU-AKSELI	KÄÄNTÖKOTELO VASEN	KÄÄNTÖKOTELO OIKEA	LAUTAS-PYÖRÄPARI
505, 605, 705 (507007→), 805 (506992→)	CARRARO 709/20	T5585 (a) 30400630	T5586 (a) 30400730	T5584 3039700, 720720
505, 605, 705, 805 (→500119), 815 (500000→), 903	CARRARO AE3			T5584 3039700, 720720

TRAKTORI-MALLI	NAVAN LAAKERI	KULUTUS-RENGAS
505, 605, 705 (507007→), 805 (506992→)	VPJ2448 30562600	T5609 31339200

a - myy T5609 myös

### KÄÄNTÖKOTELO

**T5632**  
30798200, 633380  
- 604

### OLKATAPPI

**T5633**  
30798300, 633380  
- 604

### TAKAPYÖRÄN PULTTI JA MUTTERI

- 205, 255, 305, 355, 365, 405, 455, 465, 555, 565, 665, 415, 415M  
- mutterin kierre M18 x 1,5 mm

**Pultti T5461**  
31132410, 655835

**Mutteri T5463**  
JB8206, F20321

### TAKAPYÖRÄN PULTTI JA MUTTERI

- 505, 605, 655, 705, 755, 805, 855, 905, 615M, 715M  
- mutterin kierre M20 x 1,5 mm

**Pultti T5462**  
671441

**Mutteri T5464**  
30247400

### PYÖRÄN PULTTI

**T5553**  
31796200  
- M20 x 1,5, Sige/Dana-etuakseliin ja -takapyörään  
- 865, 600, 700, 800, 900, 505, 605, 655, 705, 755, 805, 855, 905, 6000, 6100, 6200, 6300, 6400, 6900, 6600, 6800, 8000, 8100, 8200, 8400, 8050, 8150, 8450, 8550, 8750, 6250Hi, 6350Hi, 6550Hi, 6650Hi, 6850Hi, 8050Hi, 8150Hi, 8350Hi, 8450Hi, 8550Hi, 8950Hi, T140e, T150, T160, T170, T180, T190

### PYÖRÄN MUTTERI

**T5554**  
JB8205  
- M20 x 1,5, Sige/Dana-etuakseliin ja -takapyörään  
- 865, 600, 700, 800, 900, 505, 605, 655, 705, 755, 805, 855, 905 (jos Sige-etuakselilla), 6000, 6100, 6200, 6300, 6400, 6900, 6600, 6800, 8000, 8100, 8200, 8400, 8050, 8150, 8450, 8550, 8750, 6250Hi, 6350Hi, 6550Hi, 6650Hi, 6850Hi, 8050Hi, 8150Hi, 8350Hi, 8450Hi, 8550Hi, 8950Hi, T140e, T160, T170, T180, T190

04.02.2008



## PIKAVAIHTEEN AKSELI

- laakeri **T5038** (LA9011),  
stefa **T5039** (KH1164)

### T5494

70044800

- 505, 605, 615, 655, 705,  
715, 755, 805, 855, 905  
- 30-hampainen, ylentävä



## PIKAVAIHTEEN AKSELI

### T5492

70043010

- 505, 605, 615, 655, 705,  
715, 755, 805, 855, 905



T5551



T5556

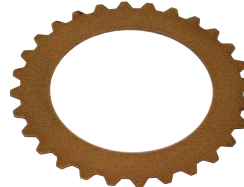

T5362



T5363

## SYNKRORENKAAAT

### T5551

30263910

- 205, 255, 305, 355, 365, 405,  
455, 465, 555, 565, 665, 865,  
415, 415M, 505, 605, 655,  
705, 755, 805, 855, 905, 615M  
715M, 600, 700, 800, 900  
- sisähalkaisija 80 mm

### T5556

30221800

- 505, 605, 655, 705,  
755, 805, 855, 905  
- sisähalkaisija 87,5 mm

## ULOSOTTOPAKAN LEVYT

- 505, 605, 615, 655, 705, 715, 755, 805, 855, 905

### Välilevy

#### T5362

30030100

- käytetään  
7 kpl/traktori

### Kitkalevy

#### T5363

30030000

- käytetään  
6 kpl/traktori

## ULOSOTTOPAKAN LEVYT

### T5647

32618700

- 6000, 6100, 6200, 6250 HI, 6300, 6350 HI, 6400,  
6550 HI, 6600, 6650 HI, 6750 HI, 6800, 6850 HI, 6900,  
8000, 8050, 8050 HI, 8100, 8150, 8150 HI, 8200, 8350  
HI, 8400, 8450, 8450 HI, 8550, 8550 HI, 8750, 8950 HI,  
A75n, A85n, A95n, T120, T130, T140, T140e, T150,  
T160, T170, T180, T190

## ULOSOTTOPAKAN LEVYT

### T5646

70029600

- 6000, 6100, 6200, 6250 HI, 6300, 6350 HI, 6400,  
6550 HI, 6600, 6650 HI, 6750 HI, 6800, 6850 HI,  
6900, 8000, 8050, 8050 HI, 8100, 8150, 8150 HI,  
8200, 8350 HI, 8400, 8450, 8450 HI, 8550, 8550 HI,  
8750, 8950 HI



22.10.2010



## ULOSOTTO-AKSELI

### T5500

- 30324300
- 205-665
- 1<sup>3</sup>/<sub>8</sub>" , 6-urainen
- traktoreihin, joissa 540 rpm

## ULOSOTTO-AKSELI

- 505, 605, 615, 655, 705, 715, 755, 805, 855, 905

### T5496

- 80381900, 30040000
- traktoreihin, joissa 540 rpm ja ajovoimanotto
- 1<sup>3</sup>/<sub>8</sub>" , 6-urainen

### T5497

- 70003700
- traktoreihin, joissa 540 ja 1000 rpm
- 1<sup>3</sup>/<sub>8</sub>" , 6-urainen

## ULOSOTTO-AKSELI

### T5548

- 31813100
- 6000, 6100, 6200, 6300, 6400, 6600, 6800, 6900, 8000, 8100, 8200, 8400, 6250Hi, 6350Hi, 6450Hi, 6550Hi, 6850Hi, 9050Hi, 8150Hi, 8350Hi, 8450Hi, 8550Hi, 8950Hi, T120, T130, T140, T150, T170, T180, T190, M120-M150, C90-C150, T120C-T170C, N91C-N141LS, T121C-T191LS
- 1<sup>3</sup>/<sub>8</sub>" , 6-urainen
- o-rengas **OR49530** (KH4932)

## ULOSOTTO-AKSELI

### T5623

- 45031120
- 255, 355, 365, 455, 465, 555, 565, 665, 865, 600, 700, 800, 900, A65, A75, A85, A95, A75n, A85n, A95n
- 1<sup>3</sup>/<sub>8</sub>" , 6-urainen
- traktoreihin, joissa 540/1000 rpm



## TRAKTORIMALLI

## VO-AKSELIN TIIVISTE

502, 602, 602T, 604

**T56003**  
KH1121

702, 703, 803, 903, 700II

**T56043**  
KH1120

205, 255, 305, 355, 365, 405, 455, 465, 555, 565, 415, 415M, 665, 865, 505, 605, 655, 705, 755, 805, 855, 905, 615M, 715M, 600, 700, 800, 900, A75n, A85n, A95n

**T56001**  
KH1191

6000, 6100, 6200, 6300, 6400, 6600, 6800, 6900, 8000, 8100, 8200, 8400, 8050, 8150, 8450, 8550, 8750, T120, T130, T140e, T150, T160, T170, T180, T190

**T56002**  
KH1405

6250HI, 6350HI, 6550HI, 6650HI, 6850HI, 8050HI, 8150HI, 8350HI, 8450HI, 8550HI, 8950HI

**T56044**  
KH1228

**G1.29**

04.03.2011



## OLKA-AKSELIN VÄÄNTIÖ

Valmet 2005

**T5504**  
4714885-3



## KÄYRÄ IMUPUTKI

**T5628**  
30247000  
- 505, 605, 655, 705, 805,  
855



## HYDRAULISEN PIKALIITTIMEN SUOJUKSET

**HC01**  
32098310  
- täydellinen  
- 1/2" pikaliittimelle  
- vuotoputken lähdöllä



**HC02**  
- pelkkä suojus  
(2 kpl pakkaus)  
- sopii kaikkiin  
1/2" pikaliittimiin

## KYTKENTÄHOLKIT



**T5182**  
686300  
- sopii pumppuihin  
T5180, T5064, T5181



**T5183**  
31877400  
- sopii pumppuihin  
T5536, T5537



**T5439**  
30428900  
- sopii pumppuihin  
T5440, T5441

## YHDYS- PUTKI

**T5442**  
30230110  
- tarvitaan,  
jos aiemmin  
pienempi pumppu



Käytä T5441 kanssa

## IMU- LETKU

**T5443**  
30229710

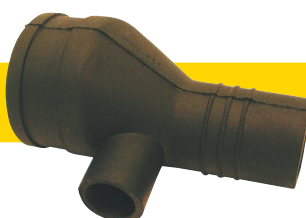

Käytä T5440 tai T5441 kanssa

## O-RENGAS- SARJA

**T5444**  
KH4952, KH4005x2,  
KH4946, KH4961x2  
- imu- ja paineliitäntöihin  
- yhdysputkeen

Käytä T5440  
tai T5441 kanssa

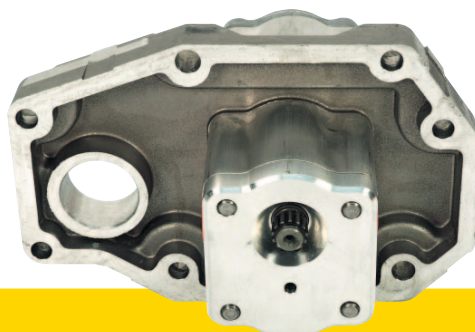
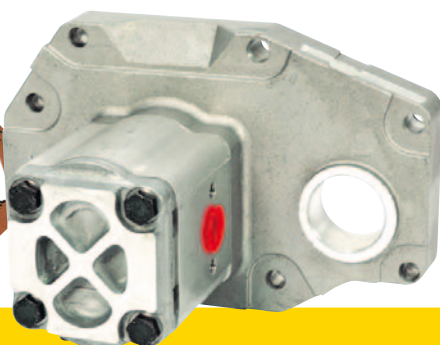

## HYDRAULIPUMPUT

**T5440**  
30225110  
- 505, 605, 655, 705, 755, 805, 855, 905  
- Carraro-etuakselilla →607100  
- tuotto 48 L / 27 L  
- tiiviste **T5622**  
- kytentäholkki **T5439** (30428900)

**T5441**  
30225120  
- 505, 605, 655, 705, 755, 805, 855, 905  
- Sige-etuakselilla, 607101→  
- tuotto 48 L / 35 L  
- tiiviste **T5622**  
- kytentäholkki **T5439** (30428900)

**G1.30**

01.12.2009

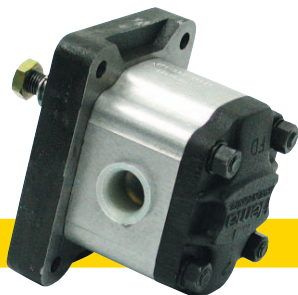

## T5050

- 130731, 61935
- 361, 565, 500
- kierrelähdöt UNF 1" ja 3/4"



## T5180

- 731310, 32905600
- 502, 602, 504, 604, 205, 255, 305, 355, 365, 405, 455, 465, 555, 565, 665, 415
- 600, 700, 800, 900 (→05/2000 mallit, joissa paineensulkuventtiili)
- hydrauliiikka 15 cm<sup>3</sup>, ohjaus 11 cm<sup>3</sup>
- sopiva kytkentäholkki **T5182** (686300)



## T5064

- 731320, 31851700
- 702, 702S, 703, 802, 803, 903, 1102, 1103, 1203, 205, 255, 305, 355, 365, 405, 455, 465, 555, 565, 665, 415, 615, 715M
- 600, 700, 800, 900 (→05/2000)
- hydrauliiikka 18 cm<sup>3</sup>, ohjaus 15 cm<sup>3</sup>
- rungon pituus 200 mm
- sopiva kytkentäholkki **T5182** (686300)
- sisältää holkin



## T5181

- 731430, 731900
- 702, 702S, 703, 802, 803, 903, 1102, 1103, 1203, 305, 405, 415, 415M, 615, 715M
- hydrauliiikka 23 cm<sup>3</sup>, ohjaus 15 cm<sup>3</sup>
- rungon pituus 217 mm
- sopiva kytkentäholkki **T5182** (686300)
- sisältää holkin

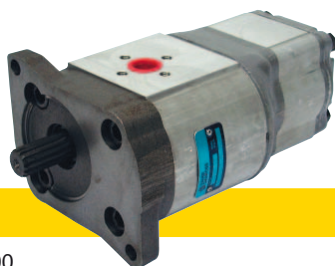

## T5536

- 31852310, 34306100
- 6000, 6100, 6200, 6300, 6400, 6600, 6800, 6900, 8000, 8100, 8200, 8400
- tuotto 23,5 + 6 cm<sup>3</sup>
- sopiva kytkentäholkki **T5183** (31877400)
- sisältää holkin
- Sauer

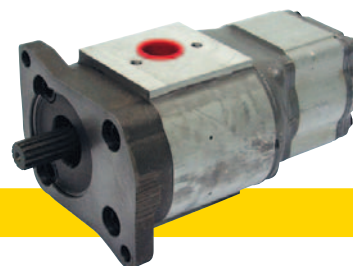

## T5537

- 31852330
- 6000, 6100, 6200, 6300, 6400, 6600, 6800, 6900, 8000, 8100, 8200, 8400 sarjano. 658900→
- 8050, 8150, 8450, 8550, 8750
- tuotto 25 + 8 cm<sup>3</sup>
- sopiva kytkentäholkki **T5183** (31877400)
- sisältää holkin
- Sauer

## T5549

- 33561800, 32863100
- 6000, 6100, 6200, 6300, 6400, 6600, 6800, 6900, 8000, 8100, 8200, 8400, 8050, 8150, 8450, 8550, 8750, T120, 130, 140, 150, 160, 170
- tuotto 25 + 11 cm<sup>3</sup>
- sisältää holkin
- Bosch



**G1.31**

22.10.2010

TRAKTORIMALLI Ulkopuolinen nostosylinteri	BOKSITIIVISTE 1.	BOKSITIIVISTE 2.
505, 605, 615M, 655, 705, 715M, 755, 805, 855, 905	<b>T56009</b> KH3305	<b>T56010</b> KH3306
865, 800 900 (c)	<b>T56012</b> KH3300	
805, 855, 905 607101→, sylinterikoko 90/40 mm	<b>T56041</b> KH3319	
6000, 6100, 6200, 6300, 6400 6900, 8000	<b>T56009</b> KH3305	<b>T56010</b> KH3306
6600, 6800, 8100, 8200, 8400 6250Hi, 6350Hi, 6550Hi, 6650Hi, 6850Hi 8050, 8150, 8450, 8550, 8750, 8050Hi, 8150Hi, 8350Hi, 8450Hi, 8550Hi, 8950Hi, T120, T130, T140e, T150, T160, T170, T180, T190	<b>T56041</b> KH3319	

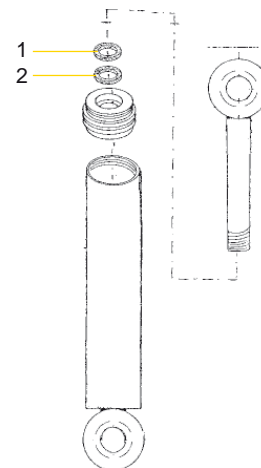

c - lisäsylinteriset mallit

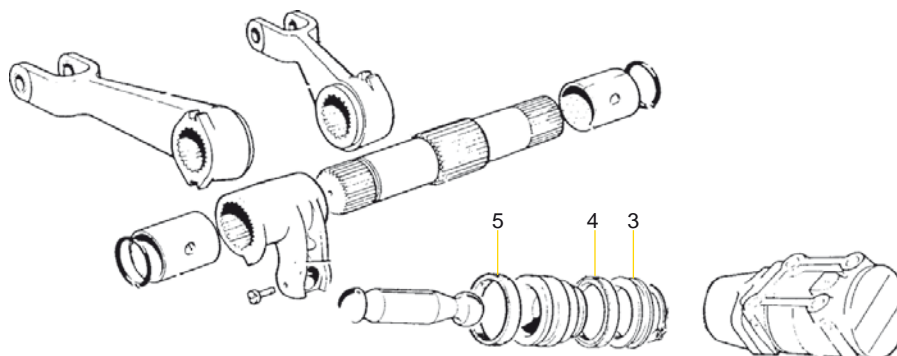

TRAKTORIMALLI Kannen alla oleva nostosylinteri	TUKIRENGAS 3.	TIIVISTE 4.	LIUKURENGAS 5.
502, 602, 602T, 604	<b>T56013</b> KH3275		
702	<b>T56014</b> KH3267	<b>T56015</b> 682790	<b>T56016</b> KH3268
903	<b>T56018</b> 859040	<b>T56017</b> KH3271	<b>T56042</b> KH3272
205, 255, 305, 355, 365, 405, 455, 465 555, 565, 665, 865, 415, 415M, 610312→	<b>T56019</b> KH3316	<b>T56020</b> KH3317	
600, 700, 800, 900	<b>T56019</b> KH3316	<b>T56020</b> KH3317	
305, 405, 415, 415M →610311	<b>T56013</b> KH3275		

26.09.2011

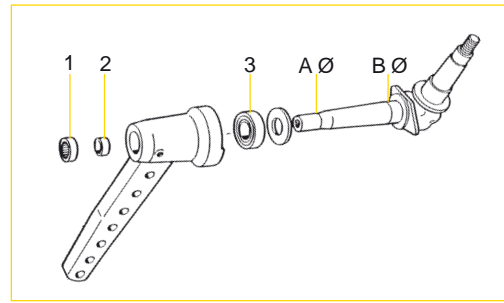

TRAKTORI-MALLI	MITAT		OLKA-AKSELI oik. ja vas.	OLKA-AKSELIN KORJ.SARJA sis. 2 x (1) 2 x (2) 2 x (3)	1 LAAKERI ULKOKEHÄ	2 LAAKERI SISÄKEHÄ	3 LAAKERI ALA
	A mm	B mm					
33, 359, 361, 565 I	30	40		T5117 (b)	T5120 (pusla 586070)		L30208
565 II, 500, 502, 504, 602, 604	31,5	40	T5256 (a) 656091	T5118 (c)	T5122 LA9008		L30208 LA5013
	35	54		T5119	T5123 LA9016	T5124 LA9017	LM806649-610 662220
700, 702, 702 S, 703, 802, 803, 903, 900 505, 605, 705, 805	35	54		T5119	T5123 LA9016	T5124 LA9017	LM806649-610 662220

a - sopii 502, 504

b - sarja sisältää 2 kpl T5120 puslaa ja 2 kpl L30208 laakeria

c - sarja sisältää 2 kpl T5122 neulalaakeria ja 2 kpl L30208 laakeria



TRAKTORI-MALLI	ETUPYÖRÄN LAAKERISARJA	
	NORMAALI AKSELI	VAHVISTETTU AKSELI
361, 565		T5016
500		T5016
502, 602, 504, 604	T5016	T5017
702, 702 S, 703, 802, 803, 903	T5017	T5112
900, 1100		T5112
1102, 1103, 1203		T5112
700		T5017

29.06.2011



T5131



T5132



T5145



T5144

TRAKTORI-MALLI	AKSELI-TYYPPI/HUOM !	SIVURAIDETANGON PÄÄT		RAIDETANGON PÄÄ ULOMPI		RAIDETANGON PÄÄ SISEMPI	
		etu	taka	vasen	oikea	vasen	oikea
33, 359, 361,500, 565		<b>T5131</b> 585270	<b>T5132</b> 585290				
502, 503, 602, 612, 604, 305, 405				<b>T5148</b> 609408	<b>T5135</b> 609409	<b>T5136</b> 609404	<b>T5136</b> 609404
700, 702, 702S, 900, 910, 1100, 1110, 1102,	a			<b>T5133</b> 821030	<b>T5133</b> 821030	<b>T5134</b> 827480	<b>T5134</b> 827480
702, 702S, 712, 703, 802, 803, 903, 1102,	b			<b>T5137</b> 698930	<b>T5133</b> 821030	<b>T5134</b> 827480	<b>T5134</b> 827480
702, 702 S, 712, 802, 803, 903, 1102,	c			<b>T5145</b> 827482	<b>T5145</b> 827482	<b>T5144</b> 688911	<b>T5144</b> 688911
505, 605,705, 805				<b>T5142</b> 30002200	<b>T5134</b> 827480		

a - mallit, joissa ohjaussylinteri moottorin sivussa  
b - mallit, joissa ohjaussylinteri on etuakselissa  
c - teollisuus- ja tvh-mallin etuakselilla

TRAKTORIMALLI	ETUAKSELI	RISTIKKO
505-805, 815, 615M, 715M 30,17 x 92 mm	CARRARO AE3 →VE/109	<b>CR098</b> 30398600
702-903, 505-905, 615M, 715M 35 x 96,8 mm	CARRARO AE3 VE/110→	<b>CR022</b> 721005
505-905 27 x 74,6 mm	CARRARO 709/20	<b>CR277</b> 633205



CR022

## OHJAUSSYLINTERIN TIIVISTESARJAT

TRAKTORI-MALLI	ETUAKSELI	OHJAUSSYLINTERIN TIIVISTESARJA
505, 605, 655, 705, 755, 805, 855, 905, 915, 615M, 715M, 6000, 6100, 6200, 6300, 6400, 6600, 6800, 6900, 8000, 8100, 8200, 8400	SIGE	<b>T56032</b> (b) 32263500
355, 365, 455, 465, 555, 565, 665, 865, 600, 700, 800, 900	SIGE	<b>T56032</b> (c) 32263500
505, 605, 705, 805, 815, 905, 615M, 715M	709/20 AE3	<b>T56034</b> 730680



b - 40 mm varsi

c - →129/92

d - 130/92→

04.03.2011

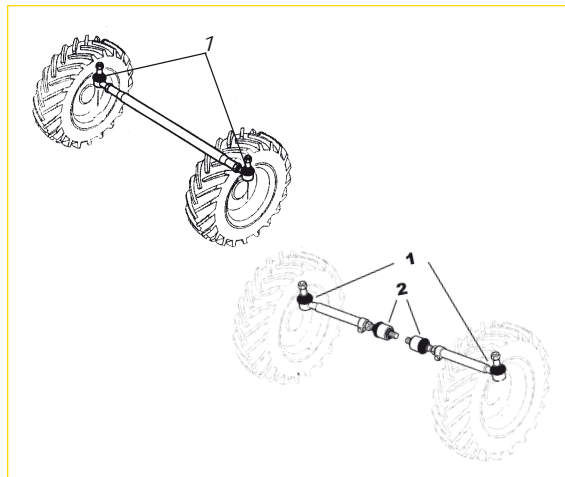
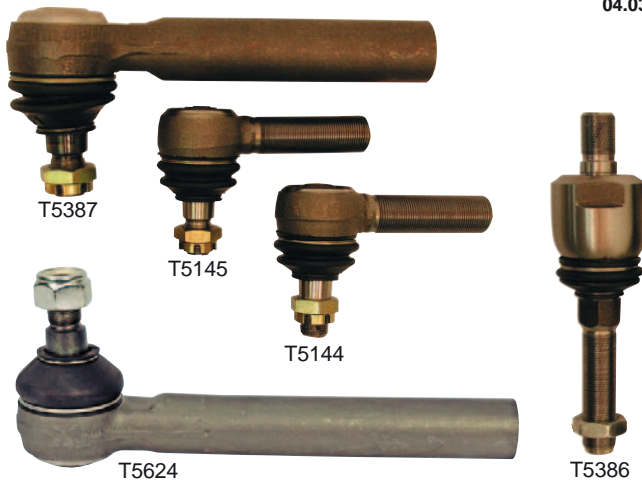

TRAKTORI-MALLI	AKSELI-TYYPPI / HUOM!	RAIDETANGON PÄÄ 1 ULOMPI		RAIDETANGON PÄÄ 2 SISEMPI	
		vasen	oikea	vasen	oikea
602-4, 604-4	CARRARO	<b>T5149</b> 633315	<b>T5136</b> 633345		
702-4, 702 S-4, 703-4, 802-4, 903-4, 803-4	CARRARO	<b>T5144</b> 688911	<b>T5145</b> 827482		
505-4, 605-4, 705-4, 805-4, 905-4	CARRARO	<b>T5146</b> (d) 30405210	<b>T5147</b> (d) 30405610		
805-4, 905-4, 505-4, 605-4, 705-4	CARRARO HD	<b>T5144</b> (e) 720885	<b>T5145</b> (e) 720886		
655-4, 755-4, 855-4	CARRARO	<b>T5144</b> 720885	<b>T5145</b> 720886		
205, 255, 305, 355, 365, 405, 455, 465, 555, 565, 665, 865, 415, 415M	ZF APL-325 →658482	<b>T5390</b> 31059900	<b>T5390</b> 31059900	<b>T5384</b> 31059800	<b>T5384</b> 31059800
	ZF APL-335 →658482	<b>T5383</b> 31372400	<b>T5383</b> 31372400	<b>T5384</b> 31059800	<b>T5384</b> 31059800
	SIGE/DANA 658483→	<b>T5385</b> 31952500	<b>T5385</b> 31952500	<b>T5543</b> (c) 31798520	<b>T5543</b> (c) 31798520
600, 700, 800, 900	SIGE/DANA 658483→	<b>T5385</b> 31952500	<b>T5385</b> 31952500	<b>T5386</b> 31798510	<b>T5386</b> 31798510
505, 605, 655, 705, 755, 805, 905, 615M, 715M	SIGE/DANA	<b>T5387</b> 31798600	<b>T5387</b> 31798600	<b>T5386</b> 31798510	<b>T5386</b> 31798510
		<b>T5542</b> (c) 31798610	<b>T5542</b> (c) 31798610	<b>T5543</b> (c) 31798520	<b>T5543</b> (c) 31798520
815M	SIGE/DANA	<b>T5388</b> 31882200	<b>T5388</b> 31882200	<b>T5386</b> 31798510	<b>T5386</b> 31798510
6000, 6100, 6300, 6400, 6600, 6800, 8000, 8100, 8200, 8400, 6250, 6350, 6550, 6650, 6850, 8050, 8150, 8350, 8450, 8550, 8950	SIGE/DANA	<b>T5387</b> 31798600	<b>T5387</b> 31798600	<b>T5386</b> 31798510	<b>T5386</b> 31798510
		<b>T5542</b> (c) 31798610	<b>T5542</b> (c) 31798610	<b>T5543</b> (c) 31798520	<b>T5543</b> (c) 31798520
		<b>T5388</b> (a) 31882200	<b>T5388</b> (a) 31882200	<b>T5543</b> (c) 31798520	<b>T5543</b> (c) 31798520
		<b>T5389</b> (b) 31882210	<b>T5389</b> (b) 31882210	<b>T5543</b> (c) 31798520	<b>T5543</b> (c) 31798520
8300, 8600		<b>VPJ3176</b> F34262761	<b>VPJ3176</b> F3426761	<b>VPJ3174</b> F34262551	<b>VPJ3174</b> F34262551
6250Hi, 6350Hi, 6550Hi, 6650Hi, 6850Hi, 8050Hi, 8150Hi, 8350Hi,	SIGE/DANA	<b>T5542</b> 31798610	<b>T5542</b> 31798610	<b>T5543</b> 31798520	<b>T5543</b> 31798520
		<b>T5389</b> (a) 31882210	<b>T5389</b> (a) 31882210		
8450Hi, 8550Hi, 8950Hi	CARRARO	<b>T5573</b> 34051700	<b>T5573</b> 34051700	<b>T5574</b> 34051500	<b>T5574</b> 34051500
T120, T130, T140, T150, T160, T170, T180, T190	CARRARO	<b>T5573</b> 34051700	<b>T5573</b> 34051700	<b>T5574</b> 34051500	<b>T5574</b> 34051500
T120, T130, T140, T160, T170, T190	SIGE/DANA	<b>T5387</b> 31798600	<b>T5387</b> 31798600	<b>T5386</b> 31798510 <b>T5543</b> (c) 31798520	<b>T5386</b> 31798510 <b>T5543</b> (c) 31798520
T120, T130, T140, T150, T160, T170, T180, T190	SIGE/DANA 730	<b>T5624</b> (f) 35728300	<b>T5624</b> (f) 35728300	<b>T5386</b> (f) 31798510	<b>T5386</b> (f) 31798510
M120, M130, M150	SIGE/DANA			<b>T5386</b> 31798510 <b>T5543</b> (c) 31798520	<b>T5386</b> 31798510 <b>T5343</b> (c) 31798520
A75, A85, A95	SIGE/DANA 720/100	<b>T5385</b> 31952500	<b>T5385</b> 31952500	<b>T5543</b> 31798520	<b>T5543</b> 31798520

a - teollisuusmalli, vanne 8 pulttia

b - teollisuusmalli 116/94-, vanne 10 pulttia

c - vahvistettu malli suuremmalla

pellonivelellä, samat asennusmitat

d - lukitus putkeen kiristyspannalla

e - lukitus putkeen mutterilla

f - 1.5.2004→

## G1.35

Alkuperäisnumerot ovat ainoastaan vertailua varten, eivätkä tarkoituksena, että tuotteet ovat alkuperäisiä. Taulukoissa esiintyvät kuvat ovat viitteellisiä.

26.09.2011



T0238



V916

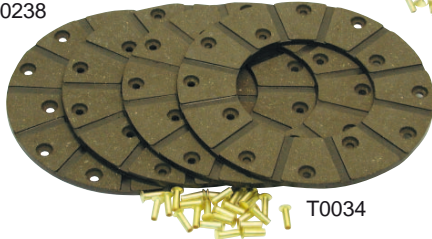

T0034



T5001



T0310



T0311

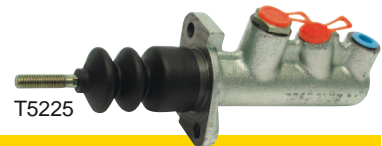

T5225

TRAKTORI-MALLI	JARRU-HIHNA-SARJA	JARRU-LEVY-SARJA	JARRU-AKSELIN STEFA	JARRU-NESTE-SÄILIÖ	JARRUN PÄÄSYLINTERI alu	JARRUN PÄÄSYLINTERI valu
33, 359, 361, 565	T0238					
500, 502, 504, 602, 604		T0034 583331	T5008 (b) KH1065			
700, 702, 703, 802, 803, 903		V916 671050	T5008 (a,b) KH1065 T5009 KH1111	T5001 813140	T0310 661910	T0311 661911
900, 1100, 1102, 1103, 1203		T0042 (C) 820230	T5010	T5001 813140		
505, 605, 615, 655, 705, 715, 755, 805, 815, 855, 905, 6000, 6100, 6300, 6400, 6600, 6900, 8000, 8050, 8100, 8150, 8200, 8400, 8450, 8550, 8750, T120, T130, T140e, T150, T160, T170, T180, T190						T5225 30294600

a - vain 700

b - 55 x 80 x 10 mm

c - sisältää 4 jarrulevyä ja nitit (36kpl)



T5002



T5226



T5003



T5006



T5210

TRAKTORI-MALLI	PÄÄSYLINTERIN KORJAUSSARJA alu	PÄÄSYLINTERIN KORJAUSSARJA valu	JARRUN TYÖ-SYLINTERI	TYÖ-SYLINTERIN KORJAUSSARJA
702, 703, 802, 803, 903 700	T5002 (a, b) 663240	T5003 (a, c) 663241	T5642 (d) 661900	T5006 662362
900, 1100, 1102, 1103, 1203	T5002 (b) 663240	T5003 (c) 663241		
505, 605, 615, 705, 715, 805, 815, 905, 655, 755, 855		T5226 30418100	T5281 30181500	T5210 30418200
6000, 6100, 6300, 6400, 6600, 6800, 8000, 8050, 8100, 8150, 8200, 8400, 8450, 8550, 8750		T5226 31418100		T5210 30418200
6000, 6100, 6200, 6300, 6400, 6600, 6800, 6900, 8000, 8100, 8300, 8400, 8600, T140e, T150, T160, T170, T180, T190			T5281 30181500	

a - ei sovi malliin 700

b - vaihtoehtonimike T5002A

c - vaihtoehtonimike T5003A

d - ilmausruuvi T5645



26.09.2011

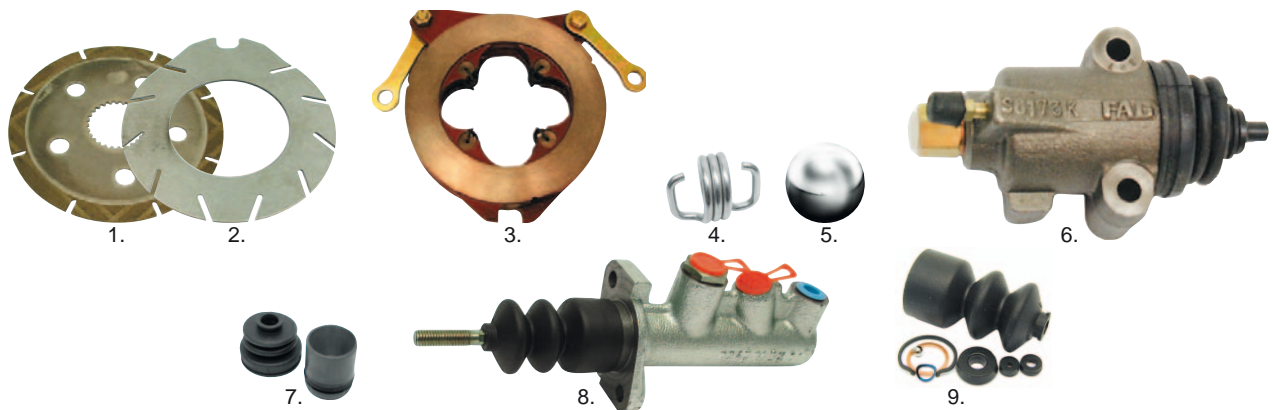

TRAKTORI-MALLI	305, 355, 405, 455	505, 605, 705, 655, 755	805, 905 855	6000, 6100, 6600, 6800, 8000, 8100, 8200, 8400	T120, T130, T140e, T150, T160, T170, T180, T190
1. Jarrulevyt		V921 (a, e) 30184800	V921 (b, e) 30184800	V921 (b, e) 30184800 T5540 (f) 32800500	
2. Välilevy	V922 (c) 411040	V922 (c) 411040	V922 (d) 411040	V922 (d) 411040 T5541 (g, d) 45037300 T5608 (h, d) 34123900	
3. Täydellinen paisutin		MF0617 411020	MF0617 411020	MF0617 411020	
4. Jousi		MF0616 412810	MF0616 412810	MF0616 412810	
5. Pallo		MF0615 412960	MF0615 412960	MF0615 412960	
6. Jarrupyöräsylinteri		T5281 30181500	T5281 30181500	T5281 30181500	
7. Jarrupyöräsylinterin korjaussarja		T5210 30418200	T5210 30418200	T5210 30418200	
8. Jarrun pääsylinteri		T5225 30294600	T5225 30294600	T5225 30294600	T5225 30294600
9. Jarrun pääsylinterin korjaussarja		T5226 30418100	T5226 30418100	T5226 30418100	T5226 30418100

a - 8 kpl/traktori  
b - 10 kpl/traktori

c - 4 kpl/traktori  
d - 6 kpl/traktori

e - keraaminen pinta  
f - orgaani pinta

g - →L11329  
h - L11330→

## NAPA-AKSELIN LAAKERI

MF0508

593200

- 500, 502, 504, 602, 604



TRAKTORI-MALLI	1. NAPA-AKSELIN ULOMPI TIIVISTE	2. NAPA-AKSELIN SISEMPI TIIVISTE
502, 503, 512, 602, 602T, 604	T56037 KH1178	
702, 703, 803, 903	T56008 KH1112	
205, 255, 305, 355, 365, 405, 415, 415M, 455, 465, 555, 565, 665	T56038 KH1198	T56005 KH1087
505, 605, 615M, 715M, 655, 705, 755, 805, 855, 865, 905, 600, 700, 800, 900, 6000, 6100, 6200, 6300, 6400, 6900, 8000		T56004 KH0232
6600, 6800, 8100, 8200, 8400, 8050, 8150, 8450, 8550, 8750	T56006 KH1218	T56007 KH0237
6250Hi, 6350Hi, 6550Hi, 6650Hi, 6850Hi, 8050Hi, 8150Hi, 8350Hi, 8450Hi, 8550Hi, 8950Hi	T56006 KH1218	T56040 KH1412

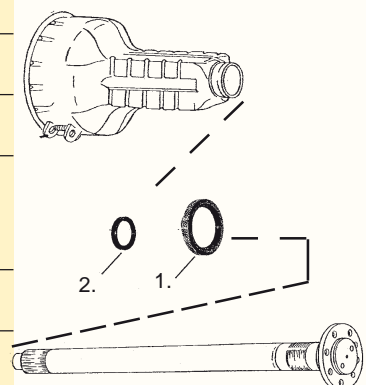

G1.37

26.09.2011

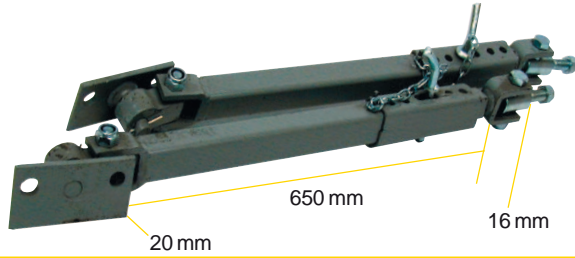

## SIVURAJOITINPARI

### T0182

- Valmet 33, 361, 565
- sisäosa 30 x 30 mm
- sokkatappi 12 mm

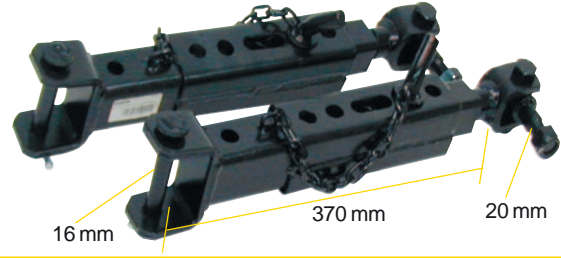

## SIVURAJOITINPARI

### T0410

- Valmet 502
- sisäosa 40 x 40 mm
- sokkatappi 16 mm

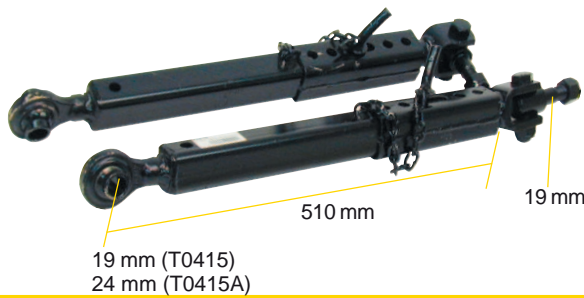

## SIVURAJOITINPARI

### T0415

### T0415A

- 505, 605, 705, 805, 905
- sisäosa 30 x 30 mm
- sokkatappi 12 mm



## SIVURAJOITINPARI

### T0451

- Valmet 702-903
- sisäosa 40 x 40 mm
- sokkatappi 16 mm



## SIVURAJOITINPARI

### T5648

- 37119000
- 6000 - 8750 (656500→)
  - 6250Hi - 6850Hi (→K36107)



## SIVURAJOITINPARI

### T5649

- 37119100
- 6000 - 8750 (K36108→)
  - 8050Hi - 8950Hi (K36108→)
  - T120 - T190 + Classic
  - M120 - M150
  - C90 - C150

## SIVURAJOITTIMEN TAPPI

### T5614

- 30344210
- 6000 ja 8000 sarjat sekä Hi-mallit, 600, 700, 800, 900, T120-190, 205, 255, 305, 355, 365, 405, 455, 465, 555, 565, 665, 415, 415M
  - sokkatappi 12M

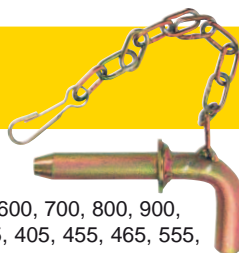

## VETOVARREN PIKAKYTKENTÄPÄÄN KORJAUSSARJAT

### T0623

- CAT II ø 56 mm
- Valtra 33471600



### T0624

- CAT III ø 64 mm
- Valtra 33471200



04.03.2011

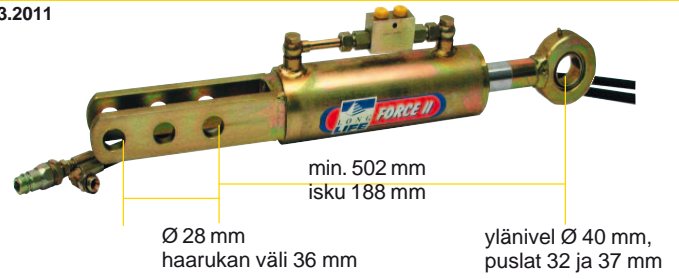
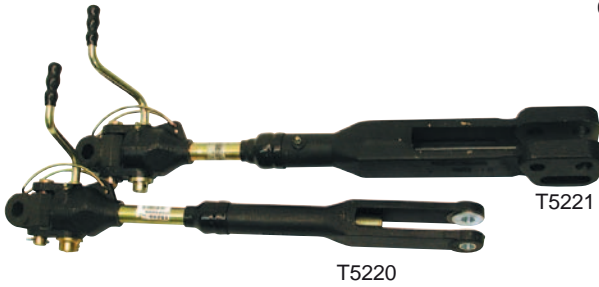

## SÄÄTÖKAMMET

### V4015

- 361, 500, 565

### T5220

- 502, 602  
504, 604  
- min. 545 mm  
- max. 710 mm

### T5221

- 700, 702, 702S,  
703, 802, 803, 903  
- min. 600 mm  
- max. 750 mm

## HYDRAULINEN SÄÄTÖKAMPI

### T1711

- 505, 605, 705, 805, 905  
- mäntä 80 mm  
- varsi 40 mm  
- puslasarja erikseen T1711-1

## SÄÄTÖKAMPI

### T5641

32775700

- 505, 605, 705, 805, 905, 6000, 6100, 6200, 6300, 6400, 6600,  
6900, 8000, 8100, 8200, 8400, 8050, 8150, 8450, 8550, 8750,  
A72, A82, A92



T5350

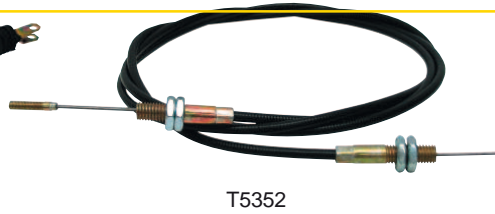

T5352



VLD1534

TRAKTORI-MALLI	JALKAKAASU-VAIJERI	KÄSIKAASU-VAIJERI	PYSÄYTIN-VAIJERI
505, 605, 515, 615, 655		T5352 30213010	VLD1534 70017100
705, 805, 715, 815, 905, 915,		T5352 30213010	VLD1534 70017100
6000, 6100, 6300, 6400, 6600, 6800,	T5350 32433810		VLD1534 32095900
8000, 8100, 8200, 8400	T5351 (a) 32433910		VLD1534 32095900
6000, 6100, 6200, 6300, 6400, 6600, 6800, 6900, 8000, 8100, 8200, 8400		T5625 32438900	
6900, 8050 HI, 8150 HI, 8350 HI, 8400 HI, 8450 HI, 8550 HI	T5606 (b) 33125200		
6200, 6250 HI, 6300, 6400, 6450 HI, 6550 HI, 6650 HI, 6750 HI, 6850 HI	T5607 (c) 33343800		

a - sopii malliin 8400 sarjanumeroon L24100 saakka

b - sopii malliin 8400 sarjanumeroon L24101 eteenpäin

c - sopii malleihin 6300,6400 sarjanumeroon L14333

## VALTRA ETUKUORMAAJIEN KAUKOSÄÄTÖKAAPELIT



FM5020311

FM5020355

TUOTENUMERO	ALKUPERÄISNUMERO	PITUUS
FM5020311	Valtra Z5020311	1,6 m
FM5020317		2,0 m
FM5020314	Valtra Z5020314	2,4 m
FM5020353	Valtra Z5020353	1,6 m
FM5020354	Valtra Z5020354	1,8 m
FM5020355	Valtra Z5020355	2,0 m
FM5020356	Valtra Z5020356	2,2 m
FM5020357	Valtra Z5020357	2,4 m
FM5020358	Valtra Z5020358	2,6 m

**Huom!** Katso kaikki etukuormaajien kaukosäätökaapelit Tarvikeluettelo T8

**G1.39**

Alkuperäisnumerot ovat ainoastaan vertailua varten, eivätkä tarkoita, että tuotteet ovat alkuperäisiä.  
Taulukoissa esiintyvät kuvat ovat viitteellisiä.



ST0360

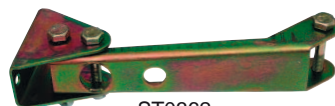

ST0362



P12336

TRAKTORI-MALLI	TYÖVALO vasen	TYÖVALO oikea	KIINNIKE	POLTTIMO
205, 255, 305, 355, 365, 405, 455, 465, 555, 565, 665, 865, 415, 415M	<b>ST0361</b> (a) 31636910	<b>ST0361</b> (a) 31636910		<b>P12336</b>
505, 605, 655, 705, 755, 805, 855, 905, 615M, 715M	<b>ST0304</b> 30181410	<b>ST0304</b> 30181410		<b>P12336</b>
6000, 6100, 6300, 6400, 6600, 6800, 8000, 8100, 8200, 8400	<b>ST0360</b> (a) 31636900	<b>ST0361</b> (a) 31636910	<b>ST0362</b> 31746210	<b>P12336</b>
T120, T130, T140e, T150, T160, T170, T180, T190	<b>ST0360</b> (a) 31636900	<b>ST0361</b> (a) 31636910		<b>P12336</b>

a - sisältää polttimon

## KATSO MYÖS MUUT TYÖVALOT TARVIKE-LUETTELOSTA !

### H3 PYÖREÄ

#### ST0322

- metalliumpio karkaistulla lasilla
- tukeva metallikuori
- valoaukko Ø 135 mm
- säätömahdollisuus 360° vaakasuunnassa, 160° pystysuunnassa
- pakkauskoko 1/24
- sopiva polttimo 12V **P12336**, 24V **P13336** (ei sisälly)



### H3 SUORAKAIDE

#### ST0605

- metalliumpio karkaistulla lasilla
- iskunkestävä polyamidikuori, väri musta
- tukeva metallijalka palloniveellä
- sivukiinnitys oikea tai vasen
- valoaukko 145 x 75 mm
- pituus 158 mm, korkeus 96 mm, syvyys 90 mm
- sopiva polttimo 12V **P12336**, 24V **P13336** (ei sisälly)
- säätömahdollisuus vaaka 180°, pysty 25°



### H3 SUORAKAIDE

#### ST0302

- metalliumpio karkaistulla lasilla
- tukeva metallikuori
- valoaukko 140 x 78 mm
- pituus 172, korkeus 100, syvyys 75 mm
- säätömahdollisuus 360° vaakasuunnassa, 160° pystysuunnassa
- pakkauskoko 1/36
- sopiva polttimo 12V **P12336**, 24V **P13336**



### H3 SUORAKAIDE

#### ST0304

- metalliumpio karkaistulla lasilla
- iskunkestävä muovikuori, väri musta
- tukeva metallinen kiinnitysalku
- valoaukko 135 x 75 mm
- säätömahdollisuus 360° vaakasuunnassa, 145° pystysuunnassa
- pakkauskoko 1/24
- sopiva polttimo 12V **P12336**, 24V **P13336**



26.09.2011

## AJOVALOLYHTY

### ST0099

- 619953  
 - 361-2, 565, 500, 700, 900, 1100  
 - normaali polttimo **P12620/P13620** (ei sisälly)  
 - metallikuori  
 - valoaukko 119 mm, ulkohalkaisija 136 mm  
 - vain varaosakäyttöön



## ETUVALON UMPIO

### ST0174

- 601360  
 - 502, 504, 602, 612, 604, 604T, 702, 702S,  
 703, 802, 803, 903, 1102, 1103, 1203  
 - polttimo **P12620/P13620**



## ETUVALON UMPIO H4

### ST0175

- 30260801  
 - 05-sarja, 15-sarja, 55-sarja, 65-sarja, 6000-sarja, 8000-sarja osittain  
 - polttimo **P12342/P13342**



## ETUVALON UMPIO

### T5621

- 34203600  
 - T120, T130, T140, T150, T160, T170, T180, T190,  
 T131, T161, T171  
 C90, C100, C110, C120, C130, C150  
 M120, M130, M150, A75, A85, A95  
 N82, N92, N101, N111E, N121, N141  
 S230, S240, S260, S280



## TAKAVALO

### MF0763

- F33899641  
 - 8300, 8600  
 - polttimot **P12499/P12498**  
 - varalasi **MF0764**

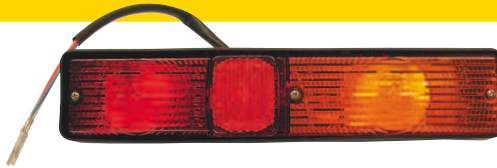

## ETUVALO

### ST100366

- 674230  
 - 02-, 03-, 04-, 05-, 15-, 55- ja 65-sarjat  
 - suuntavalo ruskeankeltainen, seisontavalo valkoinen  
 - sopii sekä oikealle että vasemmalle puolelle  
 - suuntavalo ylös- tai ulospäin  
 - kiinnitysruuvien M6 väli 50 mm  
 - polttimot **P12821/P13821** ja **P12498/P13498** (eivät sisälly)  
 - varalasi **ST100367**  
 - vain varaosakäyttöön



## TAKAVALO

### ST100361

- 30100200  
 - 02-, 03-, 04-, 05-, 15-, 55- ja 65-sarjat  
 - suuntavalo ruskeankeltainen, taka- ja jarruvalot punaiset  
 - sopii sekä oikealle että vasemmalle puolelle  
 - suuntavalo ylös- tai ulospäin  
 - kiinnitysruuvien M6 väli 50 mm  
 - polttimot **P12499/P13499** ja **P12498/P13498** (eivät sisälly)  
 - varalasi **ST100362**  
 - vain varaosakäyttöön

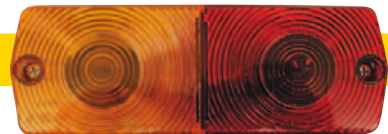

## ETUVALO

### ST342115211

- 31540700  
 - 6000-sarja, 8000-sarja osittain  
 - suuntavalo ruskeankeltainen, seisontavalo valkoinen  
 - sopii sekä oikealle että vasemmalle puolelle  
 - asennus vaaka- tai pystysuoraan  
 - kiinnitysruuvien M6 väli 50 mm  
 - polttimot **P12821/P13821** ja **P12498/P13498** (eivät sisälly)  
 - varalasi (etuseisontavilkku) **ST342137211**

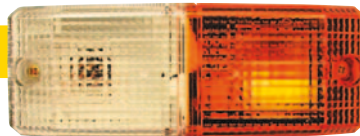

## TAKAVALO

### ST342115111

- 31540600  
 - 6000-sarja, 8000-sarja osittain  
 - suuntavalo ruskeankeltainen, taka- ja jarruvalo punaiset  
 - sopii sekä oikealle että vasemmalle puolelle  
 - asennus vaaka- tai pystysuoraan  
 - kiinnitysruuvien M6 väli 50 mm  
 - polttimot **P12499/P13499** ja **P12498/P13498** (eivät sisälly)  
 - varalasi **ST342137111**

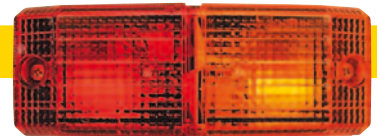

**G1.41**

26.09.2011

## LÄMMITYSLAITTEEN KENNO

### T5615

610980

- 205, 255, 305, 355, 365, 405, 415, 415M, 455, 465, 502, 503, 504, 555, 565, 600, 602, 604, 665, 700, 800, 865, 900, A65, A75, A85, A95
- **HUOM!** myy lisäksi lämmityslaitteen säätösarja **T5627** malleihin 502, 503, 602 ja 604



## LÄMMITYSLAITTEEN HANA

### T5626

715130

- 6000, 6100, 6300, 6400, 6600, 6800, 6900, 8000, 8100, 8200, 8400, 8050, 8150, 8450, 8550, 8750, 6250Hi, 6350Hi, 6550Hi, 6650Hi, 6750Hi, 6850Hi, 8050Hi, 8150Hi, 8350Hi, 8450Hi, 8550Hi, 8950Hi, T120, T130, T140, T160, T170

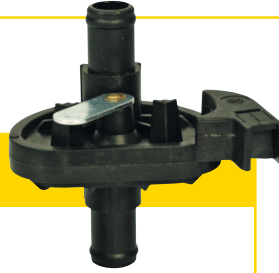

## LÄMMITYSLAITTEEN MOOTTORI

### ST0145

609984

- 500-1100, 502-1203
- yksipäisellä akselilla



## LÄMMITYSLAITTEEN MOOTTORIT - yksipäisellä akselilla

### T5156

T50009

- 505, 605, 705, 805, 905, 655, 755, 855, 955
- oikea

### T5155

T50010

- 504, 604, 205, 305, 405, 355, 455, 505, 605, 705, 805, 905, 655, 755, 855, 955
- vasen

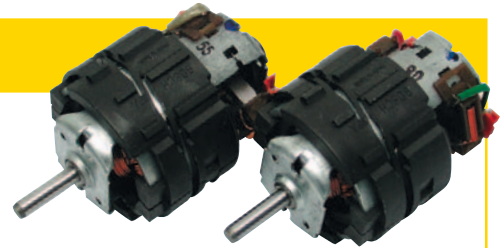

## LÄMMITYSLAITTEEN MOOTTORI

### T5284

31691800

- 6000, 6100, 6300, 6400, 6600, 6800, 8000, 8100, 8300, 8400 sarja numeroon →656099
- kaksipäisellä akselilla
- koko pituus 211 mm

## LÄMMITYSLAITTEEN MOOTTORI

### T4214 (a)

33508700

- 6000, 6100, 6200, 6300, 6400, 6600, 6800, 6900, 8000, 8100, 8200, 8400, 6250HI, 6350HI, 6450HI, 6550HI, 6850HI, 9050HI, 8150HI, 8350HI, 8450HI, 8550HI, 8950HI sarjanrosta 656100→
- koko pituus 260 mm

## LÄMMITYSLAITTEEN TÄYDELLINEN PUHALLIN

### T5550 (a)

32729820, 32729810

- 6000, 6100, 6200, 6300, 6400, 6600, 6800, 6900, 8000, 8100, 8200, 8400, 6250HI, 6350HI, 6450HI, 6550HI, 6850HI, 9050HI, 8150HI, 8350HI, 8450HI, 8550HI, 8950HI (656100→), T120, T130, T140e, T150, T160, T170, T180, T190

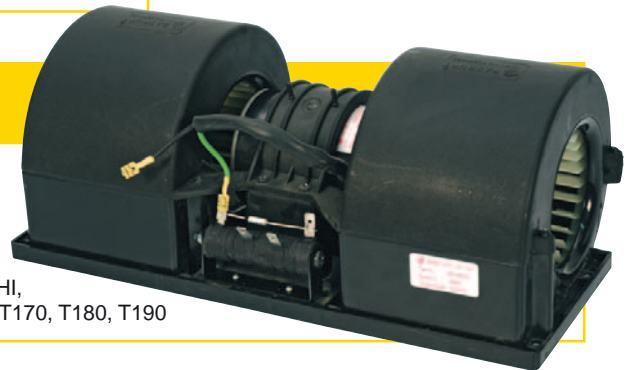

a - malleissa 600, 700, 800 ja 900 käytetään katon lämmityslaitteessa

**G1.42**

Alkuperäisnumerot ovat ainoastaan vertailua varten, eivätkä tarkoita, että tuotteet ovat alkuperäisiä. Taulukoissa esiintyvät kuvat ovat viitteellisiä.

05.02.2010

## LOKASUOJAPARI

### T5634

33170410, 33170510

- leveys 485 mm
- 6000, 6100, 6200, 6300, 6400, 6600, 6800, 6900, 8100, 8200, 8400, 8050, 8150, 8450, 8550, 8750 + Hi-mallit, 6250Hi, 6350Hi, 6550Hi, 6650Hi, 6750Hi, 6850Hi



## MERKKI

### T5636

- A75, A85, A95, T120, T130, T140, T150, T160, T170, T180, T190, 6000, 6100, 6200, 6300, 6400, 6600, 6800, 6900, 8000, 8100, 8200, 8400, 8050, 8150, 8450, 8550, 8750, Hi-mallit



## MERKKI KEULAAN

### T5637

34408300

- A75, A85, A95, T120, T130, T140, T150, T160, T170, T180, T190

## PEITELEVY

### T5638

30302840

- A75, A85, A95, T120, T130, T140, T150, T160, T170, T180, T190, 6000, 6100, 6200, 6300, 6400, 6600, 6800, 6900, 8000, 8100, 8200, 8400, 8050, 8150, 8450, 8550, 8750 + Hi



## VAIHDEVIVUN NUPPI

### T5635

34187000

- 6000-, 8000-, A- ja T-sarjat



## AJOVALON KEHYS OIKEA

### T5640

34594600, 34594610

- A75, A85, A95, T120, T130, T140, T150, T160, T170, T180, T190

## AJOVALON KEHYS VASEN

### T5639

34594500, 34594510

- A75, A85, A95, T120, T130, T140, T150, T160, T170, T180, T190





25.07.2008



Kuvassa  
oikea

## OVEN LUKKO

- 02, 03, 04 sarjat

**Vasen**  
**T0312**  
606747

**Oikea**  
**T0313**  
606748

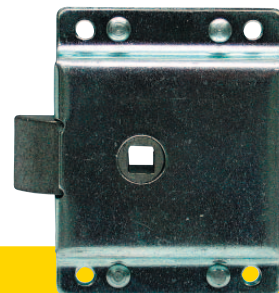

## OVEN LUKKO

**T0138**  
715370  
- 02, 03, 04 sarjat



## LUKON KAHVAT

- 02, 03, 04 sarjat

**Sisäkahva**  
**T0140**  
675200



**Ulkokahva**  
**T0139**  
606750  
- ilman lukkoa



**Ulkokahva**  
**VLD1413**  
- lukollinen



## OHJAAMON SISÄVALOT

- 02, 03, 04, 05-sarjat
- mattavalkoinen lasi
- keinukytkin
- kaksi Ø 5 mm reikää kiinnitysruuveja varten, ruuvinväli 100 mm
- ruuvit eivät kuulu toimitukseen

**ST342114210**  
valkoinen runko

**ST342114410**  
musta runko



## PYYHKIJÄNSULAT

**VLC3225**  
30302108  
- 205, 305, 405, 455, 505, 555, 605, 655,  
705, 755, 805, 855, 905, 8100, 8300, 8600  
- katso Tarvikeluettelon T1-välikkö

**VLC3223**  
3620123M91  
- 02-, 03- ja 04-sarjat

**G1.43**

26.09.2011



T0318

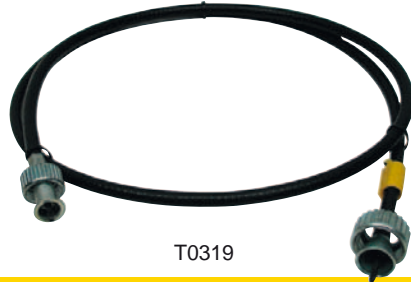

T0319



T5043

T5276



ST0146

TRAKTORI-MALLI	POLTTOAINE- JA LÄMPÖ-MITTARI	TUNTI-MITTARIN VAJERI	LÄMPÖ-MITTARIN ANTURI	ÖLJY-KELLO
502, 504, 602, 604	<b>T0318</b> 30919300	<b>T0319</b> 649371	<b>T5043</b> 619660	<b>ST0146</b> 619400
700, 900, 1100	<b>T0318</b> 30919300	<b>T0319</b> 649371		<b>ST0146</b> 619400
702 (a), 703, 802, 803, 903, 1102, 1202, 1203	<b>T0318</b> 30919300	<b>T0319</b> 649371	<b>T5043</b> 619660	<b>ST0146</b> 619400
505, 605, 705, 805, 905, 855, 615, 715, 755, 815			<b>T5276</b> 654271208	<b>ST0146</b> 619400
255, 355, 365, 455, 465, 555, 565, 665			<b>T5276</b> 654271208	<b>ST0146</b> 887283760
205, 305, 355, 405, 455, 415			<b>T5276</b> 654271208	<b>ST0146</b> 619400
6000, 6100, 6300, 6400, 6600, 6800, 8000, 8100, 8200, 8400, 865			<b>T5276</b> 654271208	<b>ST0146</b> 887283760
T120, T130, T140e, T150, T160, T170				<b>ST0146 (b)</b> 887283760

a - ei malleihin jossa on Import-pumppu

b - →N12649

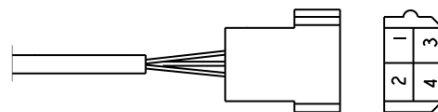

- 1 = punainen (+12 V)
- 2 = musta (maa)
- 3 = valkoinen (varoitussvalo, 12 V, max. 1,2 W)
- 4 = vihreä (signaali)



## POLTTOAINEMITTARIN ANTURI

**T5631**

- 30910200
- 205, 255, 305, 355, 365, 405, 415, 415M, 455, 465, 555, 565, 665, 865



## POLTTOAINETANKIN ANTURI

**T5587**

- 33154300
- 600, 700, 800, 900, A75n, A85n, A95n

**G1.44**

25.07.2008

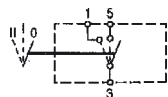

## LÄMMITYSLAITTEEN KEINUKATKAISIN

### ST7071

30944000  
- 3 napainen  
- 205-405, 355-555, 365-865, 600-900, 6000-6900, 6250Hi, 8000-8750, T120C-T170C, A85N-95N, T120CH-T170CH, T120-T190, 415M

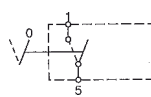

## TYÖVALON KATKAISIN

### ST7076

30944200  
- 2 napainen  
- 205-905, 255-755, 365-865, 615M-715M, 600-900, 6000-6900, 6250Hi-8950Hi, 8000-8750, A75N-A95N, T120C-T170C, T120CH-T170CH, T120-T190, 415M



## VAROITUSVALO (HÄTÄVILKKU)

### ST7089

31781000  
- 7 napainen  
- 865, 600, 700, 800, 900, 6000-6900, 8000-8750, T120C-T170C, T120CH-T170CH

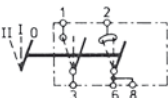

## AJOVALOT

### ST7088

30944100, 35185000  
- 5 napainen  
- 205-405, 355-555, 365-865, 415M, 600-900, 6000-6900, 6250Hi-8950Hi, 8000-8750, A75N-A95N, T120C-T170C, T120CH-T170CH, T120-T190

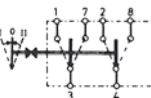

## LASINPYYHKIJÄN KATKAISIN

### ST7079

32276400  
- 6 napainen  
- 205-905, 255-855, 365-865, 415, 415M, 615M-715M, 600-900, 6000-6900, 6250Hi-8950Hi, 8000-8750, A75N-A95N, T120C-T170C, T120CH-T170CH, T140ECH, T120-T190, T140E



## NOSTOLAITTEEN KEINUKATKAISIN

### ST7073

31877500  
- 6 napainen  
- 255-555, 365-865, 600-900, 6000-6900, 6250Hi-8950Hi, 8000-8750, A75N-A95N, T120C-T170C, T120CH-T170CH, T140ECH, T120-T190, T140E

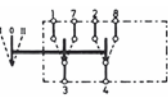

## NOSTOLAITTEEN KATKAISIN

### ST7078

32733300  
- 6 napainen  
- 255-555, 365-865, 600-900, 6000-6900, 6250Hi-8950Hi, 8000-8750, A75N-A95N, T120-T190

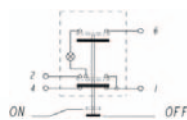

## PAINOKYTKIN SIVUKOTELOSSA PTO

### ST7030

30695900, 32693000  
- 4 napainen  
- 505-805, 655-855, 615M, 715M, 600-900, 6000-6900, 8000-8750

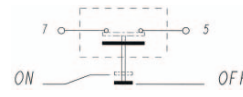

## NOSTOLAITTEEN PAINOKYTKIN LOKASUOJASSA

### ST7042

30572200  
- 2 napainen  
- 255-855, 365-865, 505-905, 600-900, A75N-A95N

G1.44a



02.01.2006



TRAKTORI-MALLI	VIRTA-LUKKO	YHDISTELMÄ-KYTKIN	VIPUKYTKIN 3-ASENT. -parkit -ajovalot	VIPUKYTKIN 2-ASENT.	VIPUKYTKIN PALAUTUVA -pissapoika
33, 359, 361, 565				ST0148 619670	
500, 700, 900, 1100	ST0087 816450			ST0148 619670	ST0150 590780
502, 504, 602, 604, 702, 703, 802, 803, 903, 1102, 1103, 1203	ST0087 816450	ST0144 (a) 619690	ST0149 619680	ST0148 619670	ST0150 590780
505, 605, 705, 805, 905, 655, 755, 855, 955	ST0178 30100800	T5367 (b) 70057500	ST0149 619680	ST0148 619670	ST0150 590780
6000, 6100, 6300, 6400, 6600, 8000, 8100, 8200, 8400, 6800 →L17306	ST0087 32553200	T5367 (b) 70057500			
6250Hi-8950Hi T120-T190		T5604 (b, c) 33536700			
6200, 6300, 6400, 6800, 8400, 6250Hi-8950Hi, 8050-8550 L17307→		T5605 (b, d) 33697900			

a - vilkut, valot, äänimerkki  
b - pissapoika, pyyhin

c - oikealla puolella, mallit joissa suunnanvaihdin

d - vasemmalla puolella

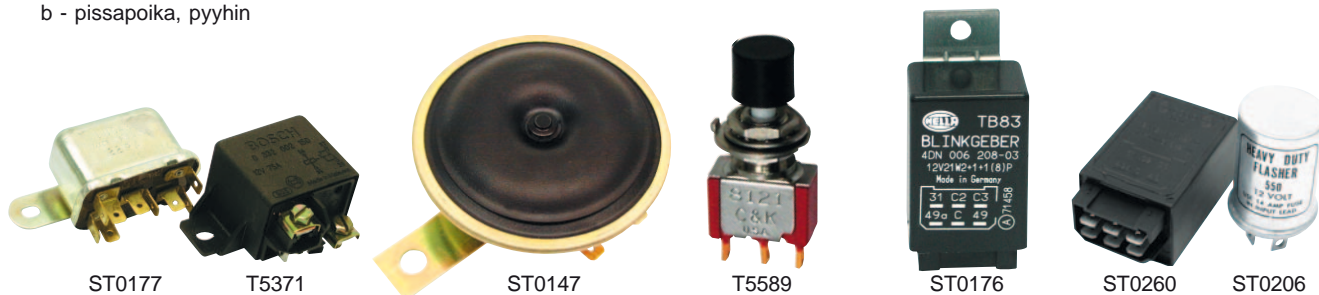

TRAKTORI-MALLI	KÄYNNISTYS-RELE	ÄÄNI-MERKKI	PAINOKYTKIN PIKAVAIHDE	VILKKU-RELE
33, 359, 361, 565		ST0147 589680		ST0206
500, 700, 900, 1100		ST0147 589680		ST0206
504, 604, 305, 405, 355, 455, 205	ST0177 687300	ST0147 589680		ST0260 30101100
502, 504, 602, 604, 702, 703, 802, 803, 903, 1102, 1103, 1203	ST0177 687300	ST0147 589680		ST0260 30101100
505, 605, 705, 805, 905, 655, 755, 855, 955, 865	T5371 30101000	ST0147 589680		ST0260 30101100
6000, 6100, 6200, 6300, 6400, 6600, 6800, 6900, 8000, 8100, 8200, 8400, 8050, 8150, 8450, 8550, 8750 + Hi-mallit			T5589 32862600 32908300	ST0260 30101100

**G1.45**

Alkuperäisnumerot ovat ainoastaan vertailua varten, eivätkä tarkoita, että tuotteet ovat alkuperäisiä.  
Taulukoissa esiintyvät kuvat ovat viitteellisiä.

04.03.2011

## Huom.

Kaikki kaasusylinterit  
Tarvikeluettelon  
T1-välikkö

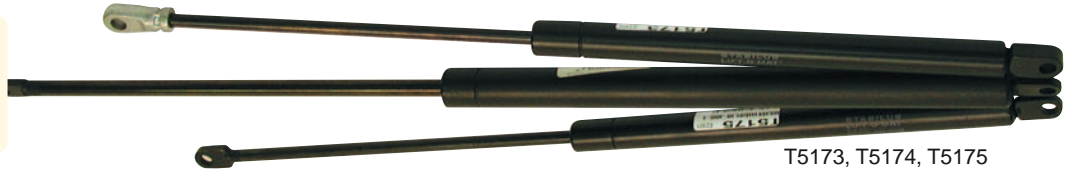

T5173, T5174, T5175

TRAKTORI- MALLI	TAKALASIN SYLINTERI	KATTOLUUKUN SYLINTERI	OVI- SYLINTERI
502, 602, 612	<b>T0316</b> <b>KS0109</b> 715740		
504, 604, 604T	<b>T5173</b> <b>KS0119</b> 30314200		
702, 702S, 703, 802, 803, 903, 1102, 1103, 1203	<b>T0316</b> <b>KS0109</b> 715740		
205, 305, 405, 415	<b>T5173</b> <b>KS0119</b> 30314200		
255, 355, 455, 555, 365, 465, 565, 665	<b>T5173</b> <b>KS0119</b> 30314200		<b>T5259</b> <b>KS0124</b> 31517900
505, 605, 515, 615, 655	<b>T5175</b> <b>KS0121</b> 30077200		<b>T5174</b> <b>KS0120</b> 30191700
705, 805, 715, 815, 755, 855, 905, 915	<b>T5175</b> <b>KS0121</b> 30077200		<b>T5174</b> <b>KS0120</b> 30191700
865, 600, 700, 800, 900	<b>T5268</b> (b) 32995000 <b>T5259</b> (c) 33116500	<b>T5258</b> (a) <b>KS0123</b> 32241400	<b>T5259</b> <b>KS0124</b> 31517900
6000, 6100, 6300 6400, 6600, 6800	<b>T5257</b> <b>KS0122</b> 31631300	<b>T5258</b> <b>KS0123</b> 32241400	<b>T5259</b> <b>KS0124</b> 31517900
6250HI, 6350HI, 6550HI, 6650HI, 6850HI, 8050HI, 8150HI, 8350HI, 8450HI, 8550HI, 8950HI	<b>T5257</b> <b>KS0122</b> 31631300	<b>T5258</b> <b>KS0123</b> 32241400	<b>T5259</b> <b>KS0124</b> 31517910
8000, 8050, 8100, 8150, 8200, 8400, 8450, 8550, 8750	<b>T5257</b> <b>KS0122</b> 31631300	<b>T5258</b> <b>KS0123</b> 32241400	<b>T5259</b> <b>KS0124</b> 31517900
8300, 8600 8800	<b>MF0767</b> <b>KS0104</b> F33895561	<b>MF0769</b> <b>KS0105</b> F33030211	<b>MF0772</b> <b>KS0108</b> F33853161
T120, T130, T140, T150, T170, T180, T190, M120, M130, M150, C90, C100, C110, C120, C130, C150, T121, T131, T151, T161, T171, T191			<b>KS0124</b> 31517900
N91, N101, N111, N121, N141,	<b>KS0122</b> (d) 31631300		<b>KS0124</b> 31517900

- a - nivelpäillä  
b - ei metsämallin ohjaamoon  
c - metsämallin ohjaamoon  
d - valmistusnumeroon W061600 saakka

## OVEN TOPPARIT



**KH0306**  
- täydellinen

**KH0307**  
- naaras

**KH0308**  
- uros

**G1.46**

04.03.2011



-02 ja -03 sarjat, 504, 604

	MALLIT	TUOTE-NRO	LASI	KUVAUS	ALKUPERÄIS- NUMERO	KOKO mm (kork. x lev. x vahv.)	VÄRI
1	502, 602	T5234	Takalasi ylempi	yksios., ei reikiä	644850		kirkas
2	703, 803, 903, 1103, 1203	T5231	Takalasi	yksios., ei reikiä	715540		kirkas
3	504, 604	T5130	Takalasi	6 + 2 reikää	30942200	1110 x 905 x 5	sävytetty

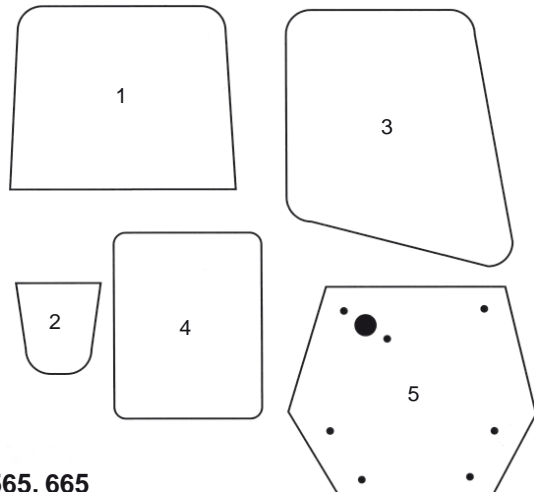

205 - 665 sarja

205, 255, 305, 355, 365, 405, 415, 415M, 455, 465, 555, 565, 665

	TUOTE-NRO	LASI	KUVAUS	ALKUPERÄIS- NUMERO	KOKO mm (kork. x lev. x vahv.)	VÄRI	KIINNITYS
1	T5590	Tuulilasi		30752800	857 x 805 x 5	sävytetty	T
2	T5591	Etulasi alempi (a)	vas. & oik.	30752900	244 x 237 x 5	sävytetty	T
3	T5592	Oven lasi	vas. & oik.	31023000	880 x 735 x 5	sävytetty	T
4	T5593	Sivulasi (a)	vas. & oik.	30753700	730 x 503 x 5	sävytetty	T
5	T5130	Takalasi	8 reikää	30942200	1110 x 905 x 5	sävytetty	R/PK
	T5520	Takalasi	8 reikää metsämallin ohj.	32738900	700 x 1050 x 5	sävytetty	

Kiinnitystavat: L = liimattu      K = kehyksellä      R = reunasuojalla  
PK = pulttikiinnitys      T = tiivisteellä

a - sopii 205, 255, 305, 355

## TUULILASILIIIMASARJA

### HK269

- annostellaan kylmänä, valumaton
- max. kiinnitysaika 25 min
- ajovalmuisaika 2 h
- sisältö: puhdistusaine 20 ml, puhdistusliina, primer 10 ml, primer-levitin, liima 310 ml



**G1.47**

Alkuperäisnumerot ovat ainoastaan vertailua varten, eivätkä tarkoita, että tuotteet ovat alkuperäisiä. Taulukoissa esiintyvät kuvat ovat viitteellisiä.

17.08.2007



## 505 - 905 sarja

505, 605, 615M, 655, 705, 715M, 755, 805, 855, 905

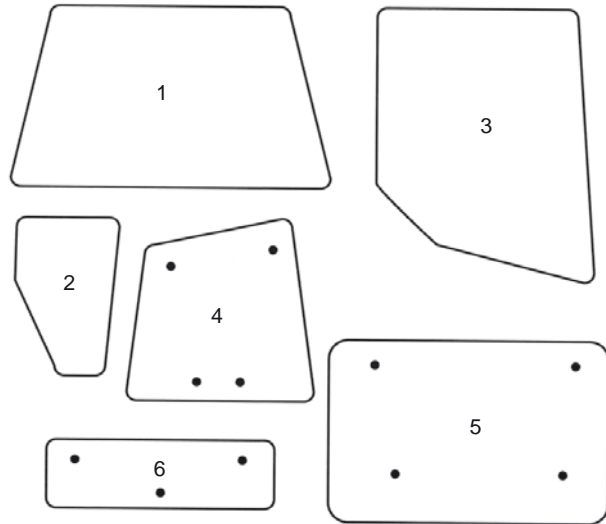

	TUOTE-NRO	LASI	KUVAUS	ALKUPERÄIS-NUMERO	KOKO mm (k ork. x lev. x vahv.)	VÄRI	KIINNITYS
1	T5530	Tuulilasi		30028400	1308 x 722 x 5	sävytetty	T
2	T5460	Etulasi alempi	vas. & oik.	30028500	668 x 452 x 5	sävytetty	T
3	T5459	Oven lasi	vas. & oik.	30104100	1033 x 725 x 5	sävytetty	T
4	T5230 (a)	Sivulasi	vas. & oik., 4 reikää	30028710	788 x 715 x 5	sävytetty	R/PK
5	T5154	Takalasi ylempi	4 reikää	30028600	1000 x 748 x 5	sävytetty	R/PK
6	T5235	Takalasi alempi	3 reikää	30002800	684 x 312 x 5	sävytetty	PK



## Huom.

**T5603**  
tuulilasin kiinnitysnauha,  
erikoisbutuulinauha  
tuulilasin kiinnittämiseen

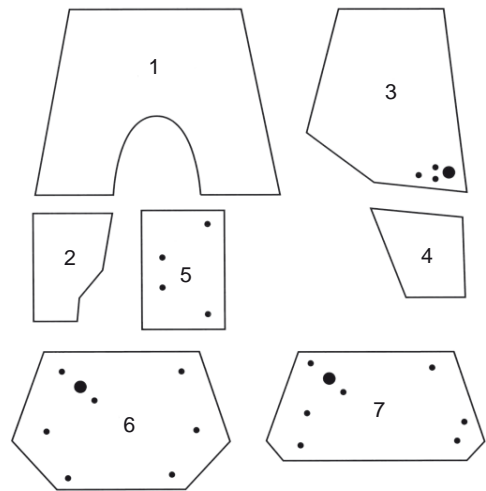

## 600 - 900 sarja, A-sarja

600, 700, 800, 865, 900, A65, A75, A85, A95

	TUOTE-NRO	LASI	KUVAUS	ALKUPERÄIS-NUMERO	KOKO mm (k ork. x lev. x vahv.)	VÄRI	KIINNITYS
1	T5594	Tuulilasi		33118200	1053 x 1050 x 5	sävytetty	L
2	T5595	Etulasi alempi	oik.	33118100	372 x 262 x 5	sävytetty	L
2	T5596	Etulasi alempi	vas.	33118000	372 x 262 x 5	sävytetty	L
3	T5597 (c)	Oven lasi ylempi	vas., 4 reikää	33191000	1010 x 913 x 5	sävytetty	L
3	T5598 (c)	Oven lasi ylempi	oik., 4 reikää	32993700	1010 x 913 x 5	sävytetty	L
4	T5599 (c)	Oven lasi alempi	vas.	33191100	532 x 415 x 5	sävytetty	L
4	T5600 (c)	Oven lasi alempi	oik.	32993800	532 x 415 x 5	sävytetty	L
5	T5601	Sivulasi	vas., 4 reikää	32993900	678 x 433 x 5	sävytetty	R/PK
5	T5602	Sivulasi	oik., 4 reikää	33191200	678 x 433 x 5	sävytetty	R/PK
6	T5391	Takalasi	8 reikää	33118300	1135 x 880 x 5	sävytetty	R/PK
7	T5518 (b)	Takalasi	8 reikää	33118900	1130 x 680 x 5	sävytetty	R/PK

a - T5230 kolme alakahvan reikää sopivat kaikkiin  
b - sopii metsämallin ohjaamoon  
c - ei A-sarjan traktoreihin

Kiinnitystavat: L = liimattu

PK = pulttikiinnitys  
K = kehyksellä  
T = tiivisteellä  
R = reunasuojalla

### G1.48

Alkuperäisnumerot ovat ainoastaan vertailua varten, eivätkä tarkoituksena, että tuotteet ovat alkuperäisiä.  
Taulukoissa esiintyvät kuvat ovat viitteellisiä.



01.12.2009



### Huom.

**T5603**  
tuulilasin kiinnitysnauha,  
erikoisbutuulinauha  
tuulilasin kiinnittämiseen

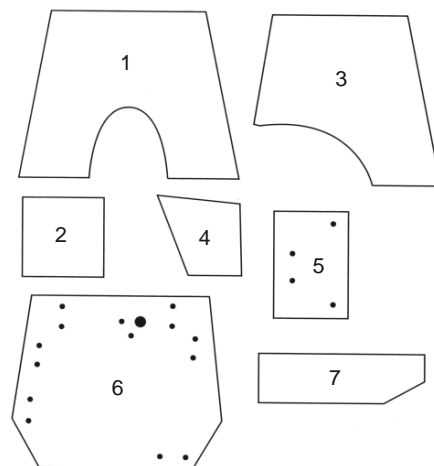

## 6000 - 8000 sarja

6000, 6100, 6200, 6250, 6300, 6350, 6400, 6550, 6600, 6650, 6800, 6850, 6900

8000, 8050, 8100, 8150, 8200, 8400, 8450, 8550, 8750, 8950

	TUOTE-NRO	LASI	KUVAUS	ALKUPERÄIS- NUMERO	KOKO mm (kork. x lev. x vahv.)	VÄRI	KIINNITYS
1	T5525	Tuulilasi	kaareva	31515400	1115 x 1285 x 5	sävytetty	L
2	T5526	Etulasi alempi	oik.	31515500	395 x 370 x 5	sävytetty	L
2	T5527	Etulasi alempi	vas.	31515600	395 x 370 x 5	sävytetty	L
3	T5521	Oven lasi ylempi	oik.	31506000	945 x 905 x 5	sävytetty	L
3	T5522	Oven lasi ylempi	vas.	31506100	945 x 905 x 5	sävytetty	L
4	T5523	Oven lasi alempi	oik.	31506200	492 x 353 x 5	sävytetty	L
4	T5524	Oven lasi alempi	vas.	31506300	492 x 353 x 5	sävytetty	L
5	T5528	Sivulasi	oik., 4 reikää	31535000	668 x 498 x 5	sävytetty	R/PK
5	T5529	Sivulasi	vas., 4 reikää	31534900	668 x 498 x 5	sävytetty	R/PK
6	T5396	Takalasi ylempi	15 reikää	31553300	1390 x 890 x 6	sävytetty	R/PK
7	T5365	Takalasi alempi	2 reikää	32054020	643 x 311 x 5	sävytetty	R/PK



### Huom.

**T5603**  
tuulilasin kiinnitysnauha,  
erikoisbutuulinauha  
tuulilasin kiinnittämiseen

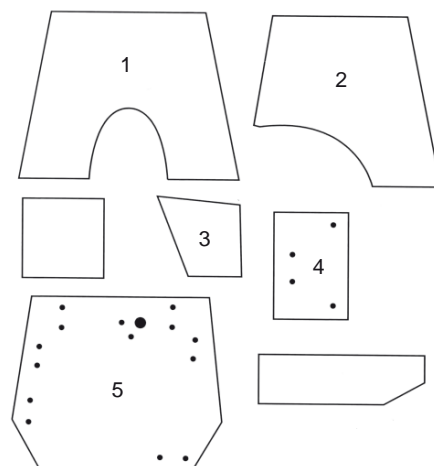

## T120-T190 sarja

	TUOTE-NRO	LASI	KUVAUS	ALKUPERÄIS- NUMERO	KOKO mm (kork. x lev. x vahv.)	VÄRI	KIINNITYS
1	T5525	Tuulilasi	kaareva	31515400	1285 x 1115 x 5	sävytetty	L
2	T5521	Oven lasi ylempi	oik.	31506000	945 x 905 x 5	sävytetty	L
2	T5522	Oven lasi ylempi	vas.	31506100	945 x 905 x 5	sävytetty	L
3	T5523	Oven lasi alempi	oik.	31506200	492 x 353 x 5	sävytetty	L
3	T5524	Oven lasi alempi	vas.	31506300	492 x 353 x 5	sävytetty	L
4	T5528	Sivulasi	oik., 4 reikää	31535000	668 x 498 x 5	sävytetty	R/PK
4	T5529	Sivulasi	vas., 4 reikää	31534900	668 x 498 x 5	sävytetty	R/PK
5	T5396	Takalasi ylempi	15 reikää, kaareva	31553300	1390 x 890 x 6	sävytetty	R/PK

Kiinnitystavat: L = liimattu K = kehyksellä R = reunasuojalla  
PK = pulttikiinnitys T = tiivisteellä

**G1.49**

Alkuperäisnumerot ovat ainoastaan vertailua varten, eivätkä tarkoita, että tuotteet ovat alkuperäisiä.  
Taulukoissa esiintyvät kuvat ovat viitteellisiä.

26.09.2011

## Huom.

### T5603

tuulilasin kiinnitysnauha,  
erikoisbutuulinauha  
tuulilasin kiinnittämiseen

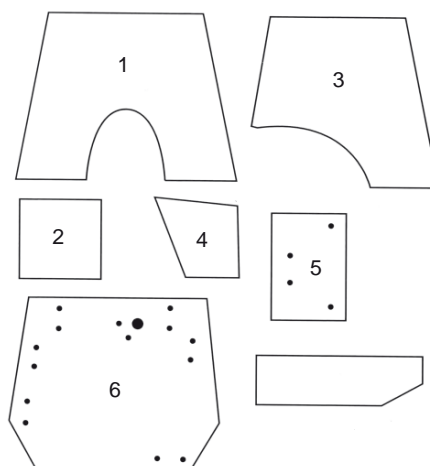

## M-sarja

M120, M130, M150

	TUOTE- NRO	LASI	KUVAUS	ALKUPERÄIS- NUMERO	KOKO mm (kork. x lev. x vahv.)	VÄRI	KIINNITYS
1	T5525	Tuulilasi	kaareva	31515400	1115 x 1285 x 5	sävytetty	L
2	T5526	Etulasi alempi	oik.	31515500	395 x 370 x 5	sävytetty	L
2	T5527	Etulasi alempi	vas.	31515600	395 x 370 x 5	sävytetty	L
3	T5521	Oven lasi ylempi	oik.	31506000	945 x 905 x 5	sävytetty	L
3	T5522	Oven lasi ylempi	vas.	31506100	945 x 905 x 5	sävytetty	L
4	T5523	Oven lasi alempi	oik.	31506200	492 x 353 x 5	sävytetty	L
4	T5524	Oven lasi alempi	vas.	31506300	492 x 353 x 5	sävytetty	L
5	T5528	Sivulasi	oik., 4 reikää	31535000	668 x 498 x 5	sävytetty	R/PK
5	T5529	Sivulasi	vas., 4 reikää	31534900	668 x 498 x 5	sävytetty	R/PK
6	T5396	Takalasi ylempi	15 reikää	31553300	1390 x 890 x 6	sävytetty	R/PK

## TAUSTAPEILIT



### ULKO-TAUSTAPEILI

#### T1502

- 30581200, 30127200
- kiinnitys putkeen Ø 16-22 mm
- 180 x 320 mm, kupera
- musta HDPE-muovitausta
- varalasi **T1522** 30581300
- E-hyväksytty



### SISÄ-TAUSTAPEILI

#### T1503

- 32875400, 30114100
- kiinnitys putkeen Ø 22 mm
- 160 x 254 mm, kupera
- musta pulverimaalattu terästausta
- varalasi **T1523**
- E-hyväksytty



### ULKO-TAUSTAPEILIT

- 02, 03, 04
- sarjat
- musta pulveri maalattu terästausta

#### T1500

- 210 x 300 mm
- kupera
- kiinnitys putkeen Ø 16-22 mm
- varalasi **T1520**
- E-hyväksytty

#### T1501

- 210 x 300 mm
- suora
- kiinnitys putkeen Ø 16-22 mm
- varalasi **T1521**
- E-hyväksytty



### VETOKOUKKU-PEILI

#### T1505

- 32738800, 30127200
- kiinnitys putkeen Ø 13-16 mm
- 135 x 185 mm, kupera
- musta muovitausta
- varalasi **T1525** 32711900
- E-hyväksytty



26.09.2011



TRAKTORI-MALLI	MOOTTORI-ÖLJY	POLTTO-AINE	ILMANSUODATIN ulompi	ILMANSUODATIN sisempi	HYDRAU-LIIKKA	VAIhteisto OHJAAMO	
20	TF5006						
205, 305, 405, 415 415M	TF4156 20410800	TF6054 DFP553004 20331343	TF2157 20228654	TF2157-2 20228655	TF52001 DFP763756 20626500	TF4156 20410800	TF21044 20531100
255	TF4136 20136346	TF6206 DFP550588 20340251			TF52001 DFP763756 20626500	TF4156 20410800	TF21044 20531100
33, 359, 361	TF5002 20107806	TF8018 (karkea) 20307790 TF7022 (hieno) 20307789					
361.2, 565, 565.2	TF5002 20107806	TF7015 (fine) 20310944					
405T, 415T	TF4156 20410800	TF6054 DFP553004 20331343	TF2157 20228654	TF2157-2 20228655	TF52001 DFP763756 20626500 →F19320	TF4156 20410800	TF21044 20531100
355, 365, 455, 465, 555, 565, 665	TF4136 20136346	TF6206 DFP550588 20340251	TF2157 20228654	TF2157-2 20228655	TF52000 DFP763757 20639610 F19321→	TF4156 20410800	TF21044 20531100
500, 542	TF5002 20107806	MPCAV296 DFP556245 20315106					
502 (vuoteen →72)	TF5002 20107806	MPCAV296 DFP556245 20315106	TF2104 20219771 →43200		TF4500 DFP554403 20650152 vuoteen →79		
502E, 503 43201→, (vuoteen →74)	TF5002 20107806	MPCAV296 DFP556245 20315106	TF2243 20228638	TF2243-2 20228639	TF4500 DFP554403 20650152		
502S (vuodesta 76→)	TF4501 DFP552819 20120822	MPCAV296 DFP556245 20315106	TF2243 20228638	TF2243-2 20228639	TF4500 DFP554403 20650152		
502 53186→, (vuoteen →79)	TF5002 20107806	MPCAV296 DFP556245 20315106	TF2243 20228638	TF2243-2 20228639	TF52001 DFP763756 20626500		TF2245 20507430
504	TF5002 20107806	MPCAV296 DFP556245 20315106	TF2243 20228638	TF2243-2 20228639	TF52001 DFP763756 20626500		TF21044 20531100
505, 605, 615M 311DS	TF4136 20136346	TF6054 DFP553004 20331343	TF2279 20236409	TF2157-2 20228655	TF52001 DFP763756 20626500	TF4150 20406000	TF21044 20531100

Ks. huomautukset sivulta G1.53

**G1.51**

Alkuperäisnumerot ovat ainoastaan vertailua varten, eivätkä tarkoita, että tuotteet ovat alkuperäisiä. Taulukoissa esiintyvät kuvat ovat viitteellisiä.

26.09.2011

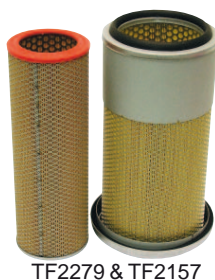

TRAKTORI-MALLI	MOOTTORI-ÖLJY	POLTTO-AINE	ILMANSUODATIN <ul style="list-style-type: none">ulompi</ul>	ILMANSUODATIN <ul style="list-style-type: none">sisempi</ul>	HYDRAU-LIIKKA	VAIhteisto Ohjaamo	
600, 700	TF4136 20136346	TF6206 DFP550588 20340251 1998→	TF2575 DFP782879 20228300	TF2575-2 20228400	TF52000 DFP763757 20639610	TF4156 20410800	TF21044 (k) 20531100 TF21189 (l) 20539400
602, 612	TF4501 20120822	MPCAV296 DFP556245 20315106	TF2104 20219771 →1895		TF52001 DFP763756 20626500		TF2245 20507430
602, 602T, 612	TF4501 DFP552819 20120822	MPCAV296 DFP556245 20315106	TF2243 20228638 1896→	TF2243-2 20228639 1896→	TF52001 DFP763756 20626500		TF2245 20507430
604 604T	TF4501 DFP552819 20120822 →7832 (604) →21391 (604T)	MPCAV296 DFP556245 20315106	TF2243 20228638	TF2243-2 20228639	TF52001 DFP763756 20626500		TF21044 20531100
604 604T	TF4136 20136346 7832→(604) 21391→(604T)	MPCAV296 DFP556245 20315106	TF2243 20228638	TF2243-2 20228639	TF52001 DFP763756 20626500		TF21044 20531100
655, 705, 755, 715, 715M	TF4135 20136342	TF6054 DFP553004 20331343	TF2279 20236409	TF2157-2 20228655	TF52001 DFP763756 20626500	TF4150 20406000	TF21044 20531100
700	TF5002 20107806	MPCAV296 DFP556245 20315106	TF2104 20219771		TF5127 20624510		
700MK2	TF5002 20107806 1916→	MPCAV296 DFP556245 20315106	TF2104 20219771		TF5127 20624510	TF4504 DFP550882 20452002	
702, 712	TF5155 20119863 411B→72	MPCAV296 DFP556245 20315106	TF2104 20219771		TF5127 20624510	TF4504 DFP550882 20452002	
702	TF4074 DFP559418 20122208 12500→ →73	MPCAV296 DFP556245 20315106	TF2104 20219771 →17194		TF5127 20624510 TF52001 DFP763756 31026500 16036→ →78	TF4504 DFP550882 20452002	
702, 703	TF4074 DFP559418 20122208 411C 17295→	MPCAV296 DFP556245 20315106	TF2243 20228638 →79	TF2243-2 20228639 →79	TF52001 DFP763756 31026500	TF4504 DFP550882 20452002	TF2245 20507430
702S, 903	TF4074 DFP559418 20122208	MPCAV296 DFP556245 20315106	TF2157V 20215237 →17295 →78		TF5127 20624510 →16471	TF4504 DFP550882 20452002	TF2245 20507430
702S, 903	TF4074 DFP559418 20122208	MPCAV296 DFP556245 20315106	TF2157 20228654 17295→ →78	TF2157-2 20228655 →78	TF52001 DFP763756 31026500 16471→	TF4504 DFP550882 20452002	TF2245 20507430
800, 900	TF4136 20136346 1998→	DFP556287 20339371 T56046 (h) DFP551429 836659300	TF2575 DFP782879 20228300	TF2575-2 20228400	TF52000 DFP763757 20639610	TF4156 20410800	TF21044 (k) 20531100 TF21189 (l) 20539400
802, 803	TF4074 DFP559418 20122208 411CS →79	MPCAV296 DFP556245 20315106	TF2157 20228654	TF2157-2 20228655	TF52001 DFP763756 20626500	TF4504 DFP550882 20452002	TF2245 2050743

Ks. huomautukset sivulta G1.53

**G1.52**

Alkuperäisnumerot ovat ainoastaan vertailua varten, eivätkä tarkoituksena, että tuotteet ovat alkuperäisiä.  
Taulukoissa esiintyvät kuvat ovat viitteellisiä.



# VALMET SUODATTIMET



26.09.2011

TRAKTORI-MALLI	MOOTTORI-ÖLJY	POLTTO-AINE	ILMANSUODATIN		HYDRAU-LIIKKA	VAIhteisto OHJAAMO	
			ulompi	sisempi			
805, 815, 855, 905	TF4135 20136342	TF6054 DFP553004 20331343	TF2279 20236409	TF2157-2 20228655	TF52001 DFP763756 20626500	TF4150 20406000	TF21044 20531100
864	TF5002 20107806	TF7015 (hieno) 20310944					
865, 865S	TF4136 20136346	MPCAV296 DFP556245 20315106 DFP556287 20339371	TF2575 DFP782879 20228300	TF2575-2 20228400	TF52001 DFP763756 20626500 TF52000 DFP763757 20639610 F19321→	TF4156 20410800	TF21044 20531100
900 (-67-73)	TF5002 20107806	MPCAV296 DFP556245 20315106	TF2104 20219771		TF5127 20624510		
900 (-97-02)		DFP551429 (h) 20315106					
902, 903	TF4074 DFP559418 20122208 411CS	MPCAV296 DFP556245 20315106	TF2157 20228654 17295→ 79→	TF2157-2 20228655	TF52001 DFP763756 20626500	TF4504 DFP550882 20452002	TF2245 20507430
1100	TF5002 20107806	MPCAV296 DFP556245 20315106	TF2157V 20215237		TF5127 20624510		
1102	TF4074 DFP559418 20122208 411BS →74	MPCAV296 DFP556245 20315106	TF2157V 20215237		TF5127 20624510		
1102, 1103	TF4074 DFP559418 20122208 411CS →79	MPCAV296 DFP556245 20315106	TF2157 20228654	TF2157-2 20228655	TF52001 DFP763756 20626500		TF2245 20507430
1203	TF4074 DFP559418 20122208 →39581	MPCAV296 DFP556245 20315106	TF2197 DFP771561 20216408		TF52001 DFP763756 20626500		TF2245 20507430
1203	TF4135 20136342 39582→	MPCAV296 DFP556245 20315106	TF2197 DFP771561 20216408		TF52001 DFP763756 20626500		TF2245 20507430
1502	TF4074 DFP559418 20122208	MPCAV296 DFP556245 20315106	TF2197 DFP771561 20216408		TF5127 20624510		
6000, 6300, 6400 6600	TF4135 20136342 →17108 →95	TF6054 DFP553004 20331343 T56046 (h) DFP551429 (h) 836659300	TF2279 20236409	TF2157-2 20228655	TF52002 20639600 →F16406 TF52000 DFP763757 20639610 F16407→	TFB20010N (e) 20602500	TF21213 (a,d) 20539500 TF21116 (c) 20531300 TF21251 (g) 20581200
6300, 6400, 6600	TF4135 20136342 17109→ 95→	TF6054 DFP553004 20331343 T56046 (h) DFP551429 (h) 836659300	TF2575 DFP782879 20228300	TF2575-2 20228400	TF52002 20639600 →F16406 TF52000 DFP763757 20639610 F16407→	TFB20010N (e) 20602500	TF21213 (a,d) 20539500 TF21116 (c) 20531300 TF21251 (g) 20581200
6100	TF4136 20136346	TF6054 DFP553004 20331343	TF2279 20236409	TF2157-2 20228655	TF52002 20639600 →F16406 TF52000 DFP763757 20639610 F16407→	TFB20010N (e) 20602500	TF21213 (a,d) 20539500 TF21116 (c) 20531300 TF21251 (g) 20581200
6200	TF4135 20136342	DFP556287 20339371 T56046 (h) DFP551429 (h) 836659300	TF2575 DFP782879 20228300	TF2575-2 20228400	TF52002 20639600 →F16406 TF52000 DFP763757 20639610 F16407→	TFB20010N (e) 20602500	TF21213 (a,d) 20539500 TF21116 (c) 20531300 TF21251 (g) 20581200
6200, 6300 N19956→ 6400 N10362→ 6250Hi, 6350Hi N19960→ 6550Hi N11771→		DFP551425 836867591 DFP551434 836862600 (h)					

- a - jos yhdellä suodattimella, numeroon F51507 asti **TF21213**, mitat 480 x 171 x 53  
c - numerosta F51508 lähtien **TF21116** (mitat 480 x 170 x 52)  
d - kaikkiin malleihin, jossa kaksi suodatinta ("suomalli") lisävaruste **TF21213**  
e - vaihteiston huohottimen suodatin

- g - vaahtomuovimalli  
h - esisuodatin  
k - suodatin konepellin päällä  
l - ilmastointilaitteen raitisilmasuodatin

## G1.53

Alkuperäisnumerot ovat ainoastaan vertailua varten, eivätkä tarkoituksenaan, että tuotteet ovat alkuperäisiä.  
Taulukoissa esiintyvät kuvat ovat viitteellisiä.

26.09.2011

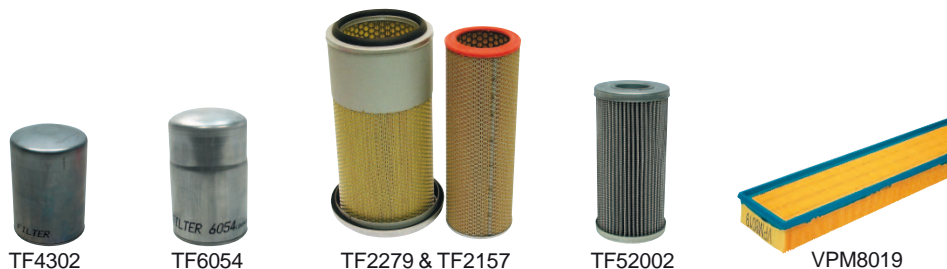

TF4302

TF6054

TF2279 & TF2157

TF52002

VPM8019

TRAKTORI-MALLI	MOOTTORI-ÖLJY	POLTTO-AINE	ILMANSUODATIN <ul style="list-style-type: none">ulompi</ul> sisempi		HYDRAU-LIIKKA	VAIhteisto OHJAAMO	
6300, 6400, 6600, 8950Hi					TF52002 20639600 →F16406 TF52000 DFP763757 20639610 F16407→		TF21213 (a,d) 20539500 TF21116 (c) 20531300 TF21251 (g) 20581200
6800	TF4302 DFP502433 20147133	TF6054 DFP553004 TF20331343 T56046 (h) DFP551429 (h) 836659300	TF2575 DFP782879 20228300	TF2575-2 20228400	TF52002 20639600 →F16406 TF52000 DFP763757 20639610 F16407→	TFB20010N (e) 20602500	TF21213 (a,d) 20539500 TF21116 (c) 20531300 TF21251 (g) 20581200
6900 8050, 8150	TF4302 DFP502433 20147133	DFP556287(x2) 20339371 DFP551430	TF2516 20238200	TF2516-2 20238300	TF52002 20639600 →F16406 TF52000 DFP763757 20639610 F16407→	TFB20010N (e) 20602500	TF21213 (a,d) 20539500 TF21116 (c) 20531300 TF21251 (g) 20581200
8000 8100	TF4302 DFP502433 20147133	TF6054 DFP553004 20331343 DFP551430	TF2279 20236409 →17108 (8000)	TF2157-2 20228655 →17108 (8000)	TF52002 20639600 →F16406 TF52000 DFP763757 20639610 F16407→	TFB20010N (e) 20602500	TF21213 (a,d) 20539500 TF21116 (c) 20531300 TF21251 (g) 20581200
8050		DFP551429 (h)					
8050 N12153→ 8150 N13239→ 8050Hi, 8150Hi N12129→		DFP551425 836867591 836867595					
8000	TF4302 DFP502433 20147133	TF6054 DFP553004 20331343	TF2516 20238200 17109→	TF2516-2 20238300 17109→	TF52002 20639600 →F16406 TF52000 DFP763757 20639610 F16407→		TF21213 (a,d) 20539500 TF21116 (c) 20531300 TF21251 (g) 20581200
8200 8400	TF4302 DFP502433 20147133	DFP556287 (x2) 20339371 DFP551430	TF2364 20246089 →668117 (8400)	TF2458-2 20252235 →668117 (8400)	TF52002 20639600 →F16406 TF52000 DFP763757 20639610 F16407→	TFB20010N (e) 20602500	TF21213 (a,d) 20539500 TF21116 (c) 20531300 TF21251 (g) 20581200
8200 8400	TF4302 DFP502433 20147133	DFP556287 (x2) 20339371	TF2516 20238200 668118→(8400)	TF2516-2 20238300 668118→(8400)	TF52002 20639600 →F16406 TF52000 DFP763757 20639610 F16407→	TFB20010N (e) 20602500	TF21213 (a,d) 20539500 TF21116 (c) 20531300 TF21251 (g) 20581200
8450, 8550, 8750	TF4302 DFP502433 20147133	DFP556287 (x2) 20339371 DFP551430	TF2516 20238200	TF2516-2 20238300	TF52002 20639600 →F16406 TF52000 DFP763757 20639610 F16407→	TFB20010N (e) 20602500	TF21213 (a,d) 20539500 TF21116 (c) 20531300 TF21251 (g) 20581200
8300, 8600	TF4160 20136459 612D, 612DS	DFP556287 (x2) 20339371	TF21108 F35807231	TF21108-1 F35807241		VPK1513 F33867011	VPM8019 F33888402
8800	TF4302 DFP502433 20147133 620DS	DFP556287 (x2) 20339371	TF21108 F35807231	TF21108-1 F35807241		VPK1513 F33867011	VPM8019 F33888402

a - jos yhdellä suodattimella, numeroon F51507 asti **TF21213**, mitat 480 x 171 x 53

b - 4 kpl / traktori

c - numerosta F51508 lähtien **TF21116** (mitat 480 x 170 x 52)

d - kaikkiin malleihin, jossa kaksi suodatinta ("suomalli") lisävaruste **TF21213**

e - vaihteiston huohottimen suodatin

f - karkea esisuodatin

g - vaahtomuovimalli

h - esisuodatin

**G1.54**



26.09.2011

TRAKTORI-MALLI	MOOTTORI-ÖLJY	POLTTO-AINE	ILMANSUODATIN		HYDRAU-LIIKKA	VAIhteisto OHJAAMO	
			ulompi	sisempi			
6250Hi, 6350Hi, 6550Hi, 6650Hi,	TF4135 20136342	DFP556287 220339371	TF2575 DFP782879 20228310	TF2575-2 2022840	TF52000 DFP763757 20639610	TFB20010N (e) 20602500	TF21213 (a,d) 20539500 TF21116 20531300 TF21251 (g) 20581200
6750Hi, 6850Hi	TF4302 DFP502433 20147133	T56046 (h) DFP551429(h) 836659300	TF2516 20238200	TF2516-2 20238300	TF52000 DFP763757 20639610	TFB20010N (e) 20602500	TF21213 (a,d) 20539500 TF21116 20531300 TF21251 (g) 20581200
8050Hi, 8150Hi, 8350Hi, 8450Hi, 8550Hi	TF4302 DFP502433 20147133	DFP556287 20339371 T56046 (h) DFP551429(h) 836659300	TF2516 20238200	TF2516-2 20238300	TF52000 DFP763757 20639610	TFB20010N (e) 20602500	TF21213 (a,d) 20539500 TF21116 20531300 TF21251 (g) 20581200
A65-2, A65-4	TF4136 20136346	TF6206 DFP550588	TF2575 DFP782879 20228300	TF2575-2 20228400	TF52000 DFP763757 20639610	TF4156 20410800	TF21044 (k) 20531100 TF21189 (l) 20539400
A75-2, A75-4, A85-2, A85-4, A95-2, A95-4	TF4136 20136346	DFP551425 836862602 DFP551434(h) 836862600	TF2575 DFP782879 20228300	TF2575-2 20228400	TF52000 DFP763757 20639610	TF4156 20410800	TF21044 (k) 20531100 TF21189 (l) 20539400
C90, C100, C110, C120, C120 EcoPower, C130, C150	TF4302 DFP502433 20147133	DFP551425 836862602 DFP551434(h) 836862600	TF2575 DFP782879 20228300	TF2575-2 20228400	TF52000 DFP763757 20639610	TFB20010N (e) 20602500	
M120, M130, M150	TF4302 DFP502433 20147133	DFP551425 836862602 DFP551434(h) 836862600	TF2575 DFP782879 20228300	TF2575-2 20228400	TF52000 (x3) DFP763757 20639610	TFB20010N (e) 20602500	TF21247 20531310 TF2911 (p) 35741210
N91, N101, N111, N111E, N121, N121 Adv., N141, N141 Adv.	TF4302 DFP502433 20147133	DFP551425(m) 836862602 DFP551434(h,m) 836862600			TF52000 (x3) DFP763757 20639610	TFB20010N (e) 20602500	TF2911 35741210
T120, T130, T140, T160, T170, T180, T190	TF4302 DFP502433 20147133	DFP551425(m) 836862602 836867595 DFP551434(h,m) 836862600 836867591	TF2516 20238200	TF2516-2 20238300	TF52000 (x3) DFP763757 20639610	TFB20010N (e) 20602500	TF21247 20531310 TF21251 (g) 20581200 TF2911 (n, p) 35741210
XM130, XM150	DFP502433 20147133 TF4302 836662580	DFP551425 836862602 DFP551434 836862600 (h)			TF52000 DFP763757 20639610		TF21251 20581200 TF2911 (p) 35741210
2005, 2105	TF4074 DFP559418 V4785974	TF6054 (x2) DFP553004 (x2) 20331343	TF2197 DFP771561 20216408	TF2197-2 V6644988	TF52002 20639600		TF21079 (b) V4771473
T132V, T150, T152V, T162V, T172V, T182V, T202V							TF2911 (n, p) 35741210
A75, A85, A95, T121, T131, T171, T191(m, n)		DFP551425 836862602					
C90, C100, C110, C120, C130, C150, M120, M130, M150, N82, N92		DFP551434 (h) 836862600					

a - suodatin  
b - 4 kpl / traktori  
e - vaihteiston huohottimen suodatin  
g - vaahtomuovimalli

h - esisuodatin  
k - suodatin konepellin päällä  
l - ilmastointilaitteen raitisilmasuodatin  
m - myös Common Rail moottoreihin

n - myös Versu/Direct mallit  
o - vain Versu/Direct mallit  
p - S03115→

## TÄYDELLINEN POLTTOAINESUODATIN KAKSOISMALLI

### F0560

81862754, 81866599, 2656818

- 1100, 1102, 1102-4, 1103, 1103-4, 1110, 1110-4, 1112, 1120, 1122, 1140, 1140-4, 1203, 1203-4, 1502, 1502-6, 500, 502, 504, 602, 604, 604T, 612, 700, 702, 702-4, 702S, 702S-4, 703, 703-4, 710, 712, 740, 8, 802, 802-4, 803, 803-4, 862, 864, 865, 900, 900-4, 903, 903-4, 910, 910-4, 920, 940, 940-4, JEHU522



**G1.55**

Alkuperäisnumerot ovat ainoastaan vertailua varten, eivätkä tarkoita, että tuotteet ovat alkuperäisiä. Taulukoissa esiintyvät kuvat ovat viitteellisiä.

## SYKLONI ESIPUHDISTIN

Esipuhdistin säästää koneen varsinaista ilmanpuhdistinta. Syklonissa ilma joutuu pyörivään liikkeeseen ja epäpuhtaudet jäävät syklonin pohjalle. Puhdistettava ajoittain.

Muut syklonit Tarvikeluettelon T12-välissä.

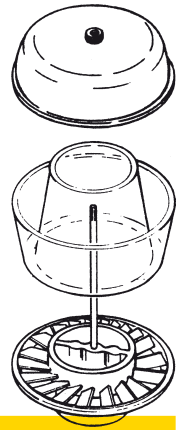

### DFH001249

- putkikoko 3"/76 mm
- varalasi DFP020227

### DFH000820

- putkikoko 3"/76 mm
- varalasi DFP016330

### DFH000822

- putkikoko 4"/101 mm
- varalasi DFP016330

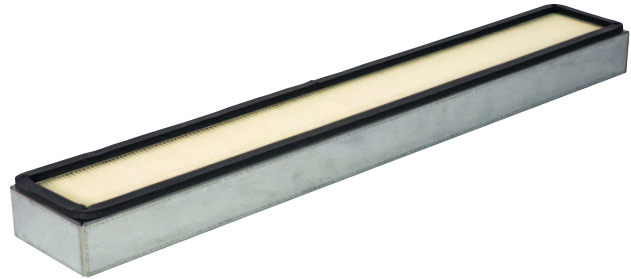
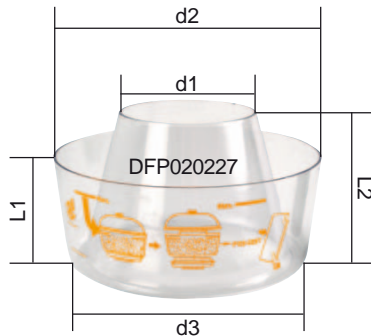

## VARALASIT MITTATAULUKKO

MITAT	DFP020227	DFP016330
d1 mm	90	141
d2 mm	183,5	266
d3 mm	140	217,5
L1 mm	77	75,5
L2 mm	106	101,5

## RAITISILMASUODATIN

### TF21177

- 20563000, 70063000
- sopii: 505-905, 855, 615M, 715M
  - mallit, joissa kattopuhallin (lisävaruste)